



westfalia
AUTOMOTIVE

*It all starts
with the towbar.*



CATALOGUE **2024**



WESTFALIA-AUTOMOTIVE – MOVES LIFE!



westfalia-automotive.com

Products by Westfalia-Automotive:

TOWBARS

- Accurate fitting
- Millions sold
- OE quality



WIRING KITS

- Easy to install
- High reliability
- Full functionality by connection to the board net



CODING - AUTOCODE-REMOTE

- Easy handling
- Fast connection



CYCLE CARRIERS

- Easy handling
- High payload
- Foldable



POWER SPRINGS

- Improved driving style
- Increased driving safety
- Less wearing of chassis parts

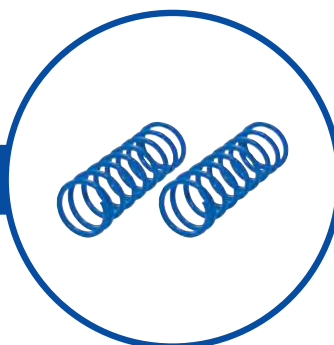



WESTFALIA-AUTOMOTIVE

Products create trust

EVERYTHING STARTS WITH THE ORIGINAL TOWBAR BY WESTFALIA-AUTOMOTIVE - LEISURE, SPORTS, PROFESSION

Security and reliability. We offer more than 1700 vehicle-specifically types of towbars of highest precision for over 85 years. In addition, you receive suitable wiring kits and coding-tools. The portfolio is rounded off with strong carrier systems for the towbar and the roof as well as power springs and accessories.

As part of the horizon global corporation (NYSE: HZN) Westfalia-Automotive operates globally. Due to this, you benefit from a global network, comprehensive know-how and the latest technologies. Westfalia-Automotive makes your work easier and safer. With constant innovation, highest quality and economical solutions.

DISCOVER NOW:

towbars | wiring-kits | bike-carrier | power springs | coding tools



[westfalia-automotive.com](https://www.westfalia-automotive.com)



COMPANY HISTORY

As the inventor of the towbar with worldwide patents, Westfalia-Automotive can naturally claim leadership in its sector since 1932. The birth of this genius idea characterizes the foundations on which the success of more than 85 years has been based: continuous innovation /// highest quality /// maximum safety /// consistent customer orientation. An additional engine of success is the targeted expansion of the product range, with which new markets, target groups and partners from the automotive industry are continually being won.

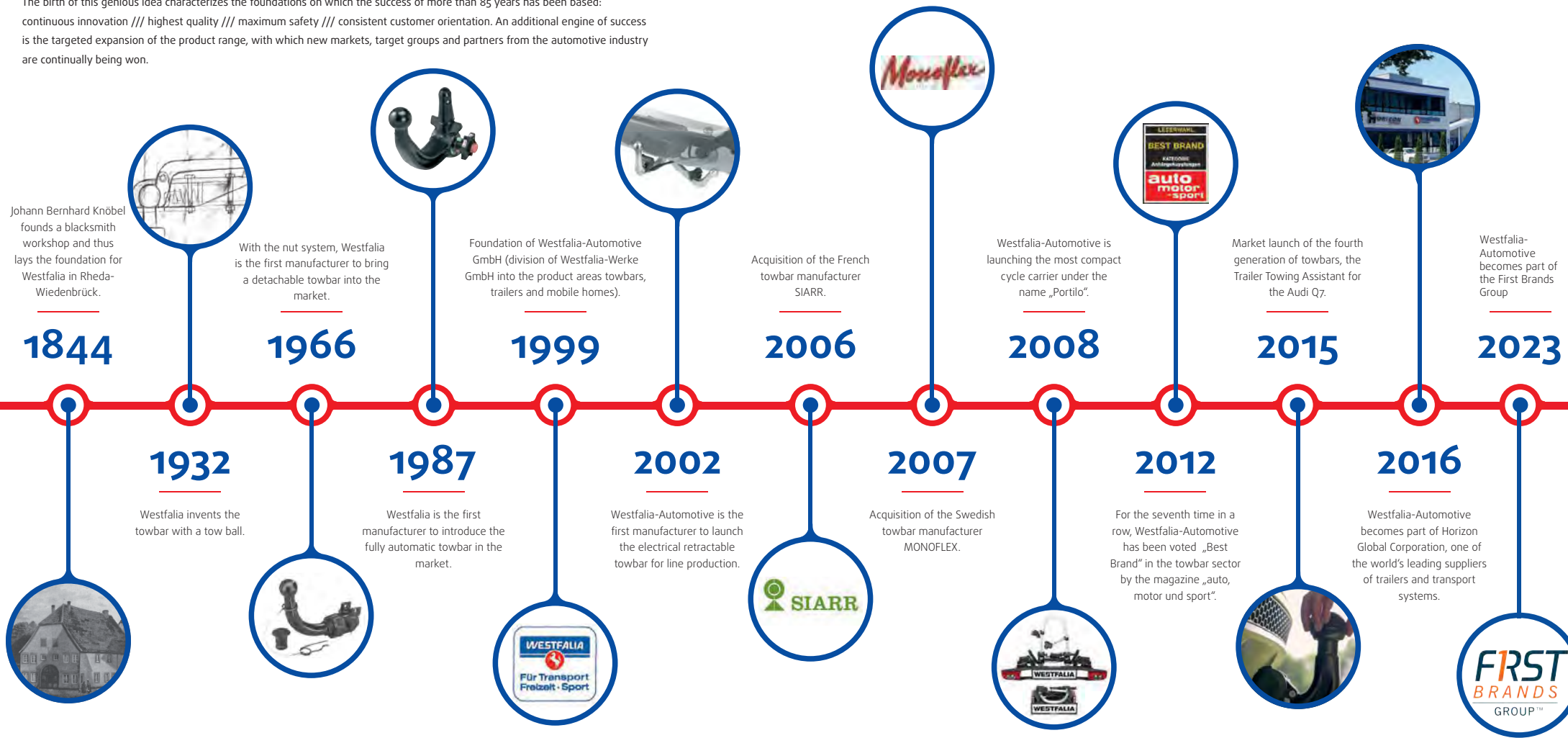

Johann Bernhard Knöbel founds a blacksmith workshop and thus lays the foundation for Westfalia in Rheda-Wiedenbrück.

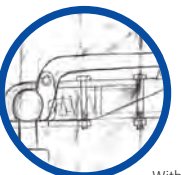

With the nut system, Westfalia is the first manufacturer to bring a detachable towbar into the market.



Foundation of Westfalia-Automotive GmbH (division of Westfalia-Werke GmbH into the product areas towbars, trailers and mobile homes).



Westfalia-Automotive is the first manufacturer to launch the electrical retractable towbar for line production.



Acquisition of the French towbar manufacturer SIARR.



Acquisition of the Swedish towbar manufacturer MONOFLEX.

Westfalia-Automotive is launching the most compact cycle carrier under the name „Portilo“.



For the seventh time in a row, Westfalia-Automotive has been voted „Best Brand“ in the towbar sector by the magazine „auto, motor und sport“.



Market launch of the fourth generation of towbars, the Trailer Towing Assistant for the Audi Q7.



Westfalia-Automotive becomes part of Horizon Global Corporation, one of the world's leading suppliers of trailers and transport systems.

Westfalia-Automotive becomes part of the First Brands Group





CYCLE CARRIER

The talented all-rounder

The bike carrier by Westfalia-Automotive is able to present a new changed rear cross member and an innovative design. Discover your multifunctional transport system for leisure, sports and profession. Easy to install, extremely compact and particularly safe with the mentality of a test winner.



maximum load up to 60 kg

E-Bike compatible

lockable



foldable



modern LED-lights
(not bikelander classic)



flexible, rubberized claws

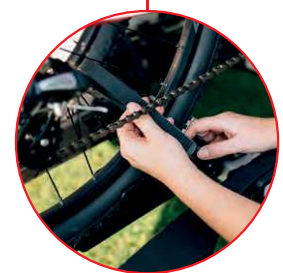

long tensioning belts

TESTED:



IT'S GENIUS: The bikelander can be easily supplemented with a box or a platform. The box offers a fast additional storage space of 220 liters. Wet, dirty or odorous things can be carried comfortably outside the vehicle. On the handy platform, you can stow bulky materials and sports equipment safely. Further useful accessories complete the range.



KITS

The perfect combination

Towbars and wiring kits by Westfalia-Automotive build the perfect partnership. Perfect fitting due to an own development and production, the system offers highest security. The involvement into the wiring system is particularly easy.

ideal connection

perfect fit

economic assembly

TOWBAR

- retractable, detachable or fixed
- reliable
- original manufacturer quality
- perfect fitting
- user-friendly
- millions sold
- EC-approved

VEHICLE-SPECIFIC WIRING KIT

- use of original parts
- easy assembly
- extremely reliable
- complete product portfolio
- full functionality through involvement into the wiring system

IT'S GENIUS: With only one article number and only one ordering process, you benefit from a real price advantage with our kits.

**Top marks again and again**

Westfalia-Automotive "Best Brand" seven times running! When choosing their "Best Brand", readers of the magazine "auto motor und sport" voted Westfalia-Automotive the winner in the "towbar" category.

RETRACTABLE TOWBAR

Always ready to use – the R10

The retractable towbar is the luxury version of towbars. Just one push on the button and it is available – no matter if you want to take a tour with your cycle carrier or if you want to go on vacation with your caravan.

PRACTICAL | SAFE | COMFORTABLE

Comfortable handling

Perfect fit and
easy to install

Maintenance-free

THE TOWBAR OFFERS

- Safe locking thanks to optical and acoustic signals
- System works independently -> no additional programming of the swivel module is necessary
- Safety chain hole easily accessible on the neck (ECE R55 approved)
- 13 pin car specific wiring kit included
- Integrated socket holder on the towball neck
- EC approved

IT'S GENIUS: The towball can become invisible without having to be removed and stowed away. So you can never lose it!



VEHICLE CODING

AUTOCODE-REMOTE

Vehicle coding has never been so easy.

After successful registration, you connect your Autocode-Remote to the OBD port of the vehicle, open our portal on a device of your choice and select your coding.

The price will be displayed without any additional costs. The coding itself is done remotely by a team of experts, almost as if the technician was sitting next to you. „Remote Diagnostics“ from Westfalia-Automotive for a wide range of models and applications and successful vehicle coding.

Remote Diagnostics

Remote coding by experienced experts

Easy to use

Vehicle coding almost at the push of a button

One solution for all

An enormous range of applications covered

Full cost transparency and control

No hidden costs





POWER SPRINGS

At last something stopping you going “weak at the knees”

Simple and effective. Under extreme conditions like a sudden evasive actions, a heavily loaded vehicle performs better with additional power springs. A significant improvement for caravans and commercial vans. The power springs are the ideal supplement to a towbar by Westfalia-Automotive, because through a joint shoring in the workshop synergy effects will occur.

Improved safety
with heavy loads

Low costs

TÜV-tested*

*by German Technical Inspection Authority

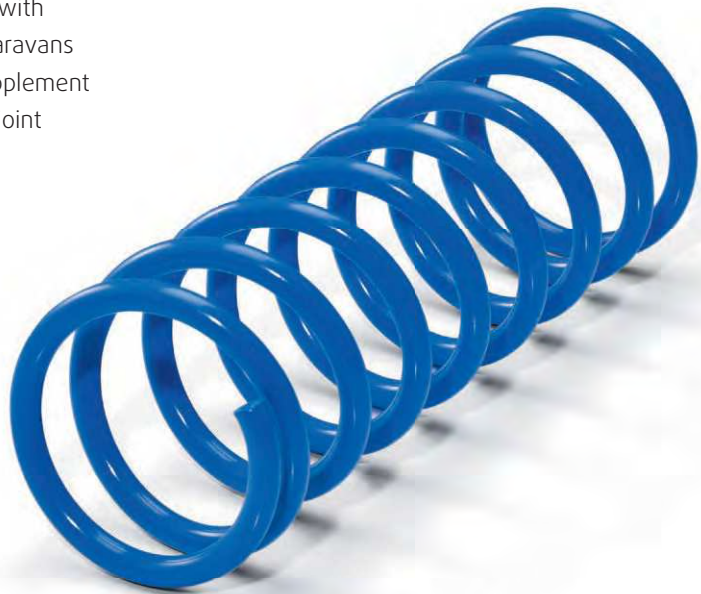

SLALOM AND OBSTACLE AVOIDANCE TEST WITH 300 KG LOAD IN BOOT.

WITHOUT POWER SPRINGS (image left)

Heavy loads can be too much for the standard suspension system of a vehicle – “bringing it to its knees” so to speak at the rear. The result: longer braking distances, risk of skidding and even possibly fishtailing in curves with crosswinds or during overtaking. This is caused by rough or uneven roads and potholes. All reasons to reinforce your vehicle’s original suspension system when driving with heavy loads.

WITHOUT POWER SPRINGS (image right)

Power springs from Westfalia-Automotive are designed to be simple and effective. Their extra boost of power is what’s needed to keep your vehicle “off its knees”. They provide extra on-road stability and offer better grip for the front tyres to keep braking distances short. You can tow heavy loads more easily while minimizing the risk of trailers or caravans fishtailing.

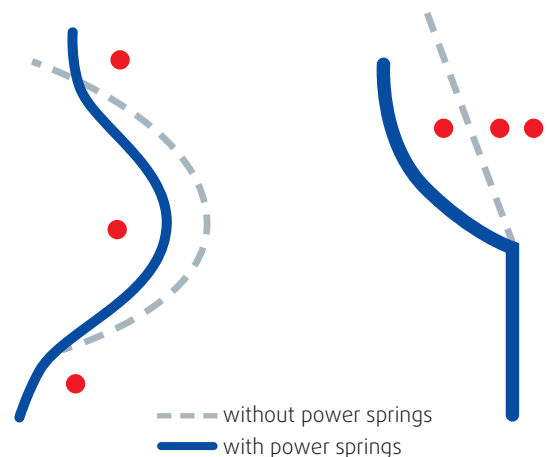



WAM-NET

Always right up to date

Who is informed, is always one step ahead.
In the Westfalia Internet you will find the right answer to almost every question. Just try it.

many assembly tips

sales promotion

availability check



TEST NOW AND BE IMPRESSED.

Create a customer account free of charge and take advantage for example of:

Newsletter-registration:

Monthly information about the latest products, product modifications and news

Availability query for products:

Always informed about what is in stock at the central warehouse

Fitting instructions:







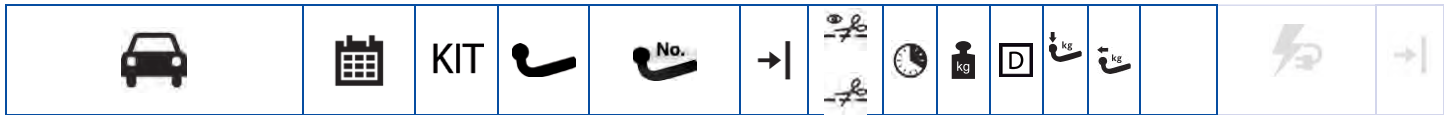

Opportunity to download the latest versions workshop marketing: sales promotion, tips and tricks, FAQs

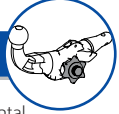

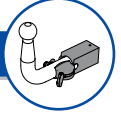
Key for towbars

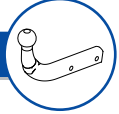

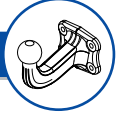
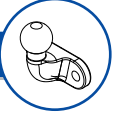
- Vehicle
- Year of manufacture
- Towbar + vehicle-specific wiring kit
- Towbar system
- Part No. towbar
- Phase-out model
- Visible cut-out
- Invisible cut-out
- Installation time
- Assembly weight
- D value kN
- Vertical load
- Towed load

<p>A40H detachable automatic system horizontal</p> 	<p>A40V detachable automatic system vertical</p> 	<p>A50 detachable small automatic system</p> 	<p>A10H detachable small automatic system</p> 
<p>F20 fixed screwed design</p> 	<p>F10 fixed welded design</p> 	<p>F40 towing bracket for ball plate (4 screws)</p> 	<p>F30 towing bracket for ball plate (2 screws)</p> 
<p>R10 schwenkbar elektrische Auslösung</p> 	<p>RH Receiver Hitch</p> 		

Key for wiring kits



- Phase-out model
- Additional information for wiring kits
- S** Wiring kit **vehicle-specific** No. ...1.7 = 7-pins
-- Wiring kit **universal** No. ...1.3 = 13-pins
- C2** Indicator monitoring **C2 indicator light**
A Indicator monitoring **acoustic**
CAN Indicator monitoring **CAN**
FRE Indicator monitoring **blink frequency**
- C** Coding/activation necessary
C1 Possible without coding -> Indicator monitoring C2 via buzzer
-- Coding/activation **not** necessary
- E** Parking aid shut-off
E1 Parking aid shut-off (universal without preliminary set-up)
E2 Parking aid shut-off (button on dashboard) if available
-- No parking aid shut-off
- D** Permanent plus included
D1 Permanent plus optional (extension kit 300027300113)
-- No Permanent plus
- L** Charging cable included
L1 Charging cable optional (extension kit 300028300113)
-- No charging cable
- V** Connection front
H Connection rear
- Installation time
- R** Right hand drive
L Left hand drive
B Both

Dear customer,

You now have the new 2024 Westfalia-Automotive catalogue covering towbars, electrical kits, bicycle racks and spare parts. We have made every effort to incorporate the suggestions and modifications that you have provided us with to further enhance this catalogue. This catalogue provides a wealth of important information and is designed to help you develop and promote your towbar fitting business.

Please note the following:

Legend

The legend for the columns in this catalogue can be found on the first pages of the catalogue..

KIT = Towbar + 13-pin electrical kit

Our KIT program has been further enhanced with the introduction of additional references. You will now find a KIT for nearly all of our towbar range which is supplied complete with a vehicle specific wiring kit. You can identify these KITs by the last figures of the part number: ... 900013.

Installation times

The specified installation times should only be used as an indication for our products of the time required to carry out an installation. The length of time required to complete this will depend on a number of factors, the condition of the vehicle and/or the skills and experience of the individual carrying out the work. In certain circumstances, the specification of a vehicle may vary significantly, such as when an automatic CD changer has to be removed in order to install the electrical equipment, then the required assembly time may increase considerably. Where possible, always try and ascertain the full specification of the vehicle. Limit the troubleshooting to approximately 0.5 hours for mechanical or 0.75 hours for electrical work in case of assembly or functional problems. In case of assembly or functional problems, contact Westfalia customer service.

Vehicles with parking sensors:

When mounting permanently attached towbars, the towball may in some instances activate the vehicles rear parking sensors. This problem can be overcome by fitting a detachable towbar where the neck can be removed from the vehicle when not required for towing. Some vehicles do come with cut off switches for the rear parking sensors but you should check with the customer to confirm that this is an acceptable solution.

The following is valid before assembling a towbar and an electrical kit:

Always observe the instructions of the vehicle manufacturer in the operating manual of the vehicle.



























Towing capacity





Please check whether a towing capacity is entered in the vehicle documents. If not the installation of a towbar is not approved by the vehicle manufacturer and is therefore not permitted. Always check the VIN plate or the vehicle handbook to verify the towing capacity of the vehicle.

Please visit our website [westfalia-automotive.com](https://www.westfalia-automotive.com) to find our current product finder, further information and frequently asked questions about our products.



















Towbars and wiring kits









Alfa Romeo

Alfa 159 Saloon exc. GTA - 250 HP	09/06-10/11			306 356 600 001		120	25.0	9.9	100	1800		306 220 300 113	→		S	FRE	--	E	D	L1	H	90	
		KIT		306 356 900 113	→		120	27.0	9.9	100	1800		included in the KIT 306 220 300 113	→		S	FRE	--	E	D	L1	H	90
Alfa 159 Sportwagon	03/06-10/11			306 356 600 001		120	25.0	9.9	100	1800		306 220 300 113	→		S	FRE	--	E	D	L1	H	90	
		KIT		306 356 900 113	→		120	27.0	9.9	100	1800		included in the KIT 306 220 300 113	→		S	FRE	--	E	D	L1	H	90
Alfa Giulia exc. Quadrifoglio inc. Veloce	05/16-			306 387 600 001		90	23.0	9.2	100	1600		306 471 300 113			S	FRE	--	E	D	L1	H	90	
		KIT		306 387 900 113			90	24.1	9.2	100	1600		included in the KIT 306 471 300 113			S	FRE	--	E	D	L1	H	90
Alfa Giulietta	04/10-12/20			306 372 600 001		90	25.0	7.7	90	1500		306 371 300 113			S	FRE	--	E	D1	L1	V	105	
Alfa Mito	09/08-07/18			306 375 600 001		90	19.0	6.7	75	1100		300 078 300 113		09/08-07/18	--	FRE	--	--	D1	L1	V		
				306 374 600 001		90	19.0	6.7	75	1100		306 606 300 113	→			S	FRE	--	E	D1	L1	V	105
Alfa Stelvio exc. Quadrifoglio	12/16-			306 518 600 001		60	24.1	11.8	120	2400		306 451 300 113		12/16-21- inc. facelift	S	FRE	--	E	D	L1	H	120	
				306 519 600 001		60	25.4	11.8	120	2400													
		KIT		306 518 900 113			60	25.0	11.8	120	2400		included in the KIT 306 451 300 113		12/16-21- inc. facelift	S	FRE	--	E	D	L1	H	120
		KIT		306 519 900 113			60	28.0	11.8	120	2400		included in the KIT 306 451 300 113		12/16-21- inc. facelift	S	FRE	--	E	D	L1	H	120













Audi A1	08/10-10/18		317 113 600 001		40	14.5	7.2	86	1200	305 329 300 113	with preliminary setup	S	CAN	C	E	D	L1	H	
										305 330 300 001	extension kit for vehicles without black support for fuse box on the passenger side	S				D1		V	60
										305 330 300 113	without preliminary setup	S	CAN	C	E	D1	L1	V	
Audi A1 Please order separately Spoiler and cover for bumper cutout at Audi dealer's.	08/10-10/18		317 114 600 001		40	15.0	7.2	86	1200	305 329 300 113	with preliminary setup	S	CAN	C	E	D	L1	H	
										305 330 300 001	extension kit for vehicles without black support for fuse box on the passenger side	S				D1		V	60
										305 330 300 113	without preliminary setup	S	CAN	C	E	D1	L1	V	
Audi A1 Sportback	02/12-10/18		317 113 600 001		40	14.5	7.2	86	1200	305 329 300 113	with preliminary setup	S	CAN	C	E	D	L1	H	
										305 330 300 001	extension kit for vehicles without black support for fuse box on the passenger side	S				D1		V	60
										305 330 300 113	without preliminary setup	S	CAN	C	E	D1	L1	V	
Audi A1 Sportback Please order separately Spoiler and cover for bumper cutout at Audi dealer's.	02/12-10/18		317 114 600 001		40	15.0	7.2	86	1200	305 329 300 113	with preliminary setup	S	CAN	C	E	D	L1	H	
										305 330 300 001	extension kit for vehicles without black support for fuse box on the passenger side	S				D1		V	60
										305 330 300 113	without preliminary setup	S	CAN	C	E	D1	L1	V	









Audi

Audi A3 exc. Quattro + S3 Please order additionally seal for frame to prevent exhaust leaking into the vehicle, order no. 900002504014.	09/96-05/03			305 222 600 001		120	17.5	8.9	75	1650		305 223 300 113			S	FRE	--	E	D1	L1	V	60
				305 223 600 001		120	16.8	8.9	75	1650												
	KIT		305 391 900 113		120	19.5	8.9	75	1650		included in the KIT 305 223 300 113			S	FRE	--	E	D1	L1	V	60	
	KIT		305 392 900 113		120	18.8	8.9	75	1650		included in the KIT 305 223 300 113			S	FRE	--	E	D1	L1	V	60	
Audi A3 Convertible models S3 04/08-: Please check if the vehicle is homologated for towing trailers by the vehicle manufacturer.	04/08-03/14			321 865 600 001		60	17.0	9.4	100	1800		305 256 300 113			S	CAN	C	E	D1	--	V	120
		KIT		305 389 900 113		60	19.0	9.4	100	1800		included in the KIT 305 256 300 113			S	CAN	C	E	D1	--	V	120
Audi A3 Convertible inc. S-Line models S3 04/08-: Please check if the vehicle is homologated for towing by the vehicle manufacturer. For optimal fit, order spoiler and cover at Audi dealer.	04/08-03/14			321 885 600 001		60	17.0	9.4	100	1800		305 256 300 113			S	CAN	C	E	D1	--	V	120
		KIT		305 390 900 113		60	19.0	9.4	100	1800		included in the KIT 305 256 300 113			S	CAN	C	E	D1	--	V	120
Audi A3 Convertible without preliminary setup exc. Quattro Please order spoiler inc. cover for bumper cutout at Audi-dealers. Attention: Depending on the engine variation it may be necessary to change the cooling system of the vehicle.	03/14-06/14	KIT		317 132 900 113		60	21.0	10.3	85	2000		included in the KIT 305 406 300 113		-06/14 without preliminary setup	S	CAN	C	E	D	L1	V	150
Audi A3 Convertible without preliminary setup exc. Quattro Attention: Depending on the engine variation it may be necessary to change the cooling system of the vehicle.	03/14-06/14	KIT		317 131 900 113		60	21.0	10.3	85	2000		included in the KIT 305 406 300 113		-06/14 without preliminary setup	S	CAN	C	E	D	L1	V	150















Audi A3 Convertible exc. Quattro Please order spoiler inc. cover for bumper cutout at Audi-dealers. Attention: Depending on the engine variation it may be necessary to change the cooling system of the vehicle.	03/14-05/16		317 132 600 001		60	19.0	10.3	85	2000	305 403 300 113	-06/14 with preliminary setup	S	CAN	C	E	D	L1	H	45
										305 406 300 113	-06/14 without preliminary setup	S	CAN	C	E	D	L1	V	150
										305 407 300 113	06/14- with preliminary setup	S	CAN	C	E	D	L	H	30
										305 408 300 107 →	06/14- without preliminary setup	S	CAN	C	E	--	--	V	60
										305 408 300 113	06/14- without preliminary setup	S	CAN	C	E	D	L	V	60
Audi A3 Convertible exc. Quattro Attention: Depending on the engine variation it may be necessary to change the cooling system of the vehicle.	03/14-05/16		317 131 600 001		60	19.0	10.3	85	2000	305 403 300 113	-06/14 with preliminary setup	S	CAN	C	E	D	L1	H	45
										305 406 300 113	-06/14 without preliminary setup	S	CAN	C	E	D	L1	V	150
										305 407 300 113	06/14- with preliminary setup	S	CAN	C	E	D	L	H	30
										305 408 300 107 →	06/14- without preliminary setup	S	CAN	C	E	--	--	V	60
										305 408 300 113	06/14- without preliminary setup	S	CAN	C	E	D	L	V	60
Audi A3 Convertible without preliminary setup exc. Quattro Attention: Depending on the engine variation it may be necessary to change the cooling system of the vehicle.	03/14-05/16	KIT 	305 418 900 113		60	20.9	10.3	85	2000	included in the KIT 305 438 300 113	inc. WLC 2.0 without preliminary setup	S	CAN	C	E	D	L1	V	90
Audi A3 Convertible without preliminary setup exc. Quattro Please order spoiler inc. cover for bumper cutout at Audi-dealers. Attention: Depending on the engine variation it may be necessary to change the cooling system of the vehicle.	03/14-05/16	KIT 	305 419 900 113		60	20.9	10.3	85	2000	included in the KIT 305 438 300 113	inc. WLC 2.0 without preliminary setup	S	CAN	C	E	D	L1	V	90













Audi

Audi A3 Convertible without preliminary setup exc. Quattro Please order spoiler inc. cover for bumper cutout at Audi-dealers. Attention: Depending on the engine variation it may be necessary to change the cooling system of the vehicle.	06/14-05/16	KIT		305 409 900 113		60	21.0	10.3	85	2000		included in the KIT 305 408 300 113	06/14- without preliminary setup	S	CAN	C	E	D	L	V	60
Audi A3 Convertible without preliminary setup exc. Quattro Attention: Depending on the engine variation it may be necessary to change the cooling system of the vehicle.	06/14-05/16	KIT		305 408 900 113		60	19.0	10.3	85	2000		included in the KIT 305 408 300 113	06/14- without preliminary setup	S	CAN	C	E	D	L	V	60
Audi A3 Convertible with preliminary setup exc. Quattro Please order spoiler inc. cover for bumper cutout at Audi-dealers. Attention: Depending on the engine variation it may be necessary to change the cooling system of the vehicle.	06/14-05/16	KIT		317 155 900 113		60	20.5	10.3	85	2000		included in the KIT 305 407 300 113	06/14- with preliminary setup	S	CAN	C	E	D	L	H	30
Audi A3 Convertible with preliminary setup exc. Quattro Attention: Depending on the engine variation it may be necessary to change the cooling system of the vehicle.	06/14-05/16	KIT		317 154 900 113		60	20.5	10.3	85	2000		included in the KIT 305 407 300 113	06/14- with preliminary setup	S	CAN	C	E	D	L	H	30
Audi A3 Saloon without preliminary setup Please order spoiler inc. cover for bumper cutout at Audi-dealers. Attention: Depending on the engine variation it may be necessary to change the cooling system of the vehicle.	09/13-06/14	KIT		317 132 900 113		60	21.0	10.3	85	2000		included in the KIT 305 406 300 113	-06/14 without preliminary setup	S	CAN	C	E	D	L1	V	150
Audi A3 Saloon without preliminary setup Attention: Depending on the engine variation it may be necessary to change the cooling system of the vehicle.	09/13-06/14	KIT		317 131 900 113		60	21.0	10.3	85	2000		included in the KIT 305 406 300 113	-06/14 without preliminary setup	S	CAN	C	E	D	L1	V	150











Audi A3 Saloon Attention: Depending on the engine variation it may be necessary to change the cooling system of the vehicle.	09/13-05/16		317 131 600 001		60	19.0	10.3	85	2000	305 403 300 113	-06/14 with preliminary setup	S	CAN	C	E	D	L1	H	45	
										305 406 300 113	-06/14 without preliminary setup	S	CAN	C	E	D	L1	V	150	
										305 407 300 113	06/14-11/19 with preliminary setup	S	CAN	C	E	D	L	H	30	
										305 408 300 107	06/14-11/19 without preliminary setup	S	CAN	C	E	--	--	V	60	
										305 408 300 113	06/14-11/19 without preliminary setup	S	CAN	C	E	D	L	V	60	
Audi A3 Saloon Please order spoiler inc. cover for bumper cutout at Audi-dealers. Attention: Depending on the engine variation it may be necessary to change the cooling system of the vehicle.	09/13-05/16		317 132 600 001		60	19.0	10.3	85	2000	305 403 300 113	-06/14 with preliminary setup	S	CAN	C	E	D	L1	H	45	
										305 406 300 113	-06/14 without preliminary setup	S	CAN	C	E	D	L1	V	150	
										305 407 300 113	06/14-11/19 with preliminary setup	S	CAN	C	E	D	L	H	30	
										305 408 300 107	06/14-11/19 without preliminary setup	S	CAN	C	E	--	--	V	60	
										305 408 300 113	06/14-11/19 without preliminary setup	S	CAN	C	E	D	L	V	60	
Audi A3 Saloon without preliminary setup Attention: Depending on the engine variation it may be necessary to change the cooling system of the vehicle.	09/13-05/16	KIT		305 418 900 113		60	20.9	10.3	85	2000	included in the KIT 305 438 300 113	inc. WLC 2.0 without preliminary setup	S	CAN	C	E	D	L1	V	90
Audi A3 Saloon without preliminary setup Please order spoiler inc. cover for bumper cutout at Audi-dealers. Attention: Depending on the engine variation it may be necessary to change the cooling system of the vehicle.	09/13-05/16	KIT		305 419 900 113		60	20.9	10.3	85	2000	included in the KIT 305 438 300 113	inc. WLC 2.0 without preliminary setup	S	CAN	C	E	D	L1	V	90

















Audi

Audi A3 Saloon without preliminary setup Please order spoiler inc. cover for bumper cutout at Audi-dealers. Attention: Depending on the engine variation it may be necessary to change the cooling system of the vehicle.	06/14-05/16	KIT		305 409 900 113		60	21.0	10.3	85	2000		included in the KIT 305 408 300 113	06/14-11/19 without preliminary setup	S	CAN	C	E	D	L	V	60
Audi A3 Saloon without preliminary setup Attention: Depending on the engine variation it may be necessary to change the cooling system of the vehicle.	06/14-05/16	KIT		305 408 900 113		60	19.0	10.3	85	2000		included in the KIT 305 408 300 113	06/14-11/19 without preliminary setup	S	CAN	C	E	D	L	V	60
Audi A3 Saloon with preliminary setup Please order spoiler inc. cover for bumper cutout at Audi-dealers. Attention: Depending on the engine variation it may be necessary to change the cooling system of the vehicle.	06/14-05/16	KIT		317 155 900 113		60	20.5	10.3	85	2000		included in the KIT 305 407 300 113	06/14-11/19 with preliminary setup	S	CAN	C	E	D	L	H	30
Audi A3 Saloon with preliminary setup Attention: Depending on the engine variation it may be necessary to change the cooling system of the vehicle.	06/14-05/16	KIT		317 154 900 113		60	20.5	10.3	85	2000		included in the KIT 305 407 300 113	06/14-11/19 with preliminary setup	S	CAN	C	E	D	L	H	30
Audi A3 Saloon (8Y) inc. S-Line inc. AdBlue inc. Hybrid	04/20-			322 094 600 001		60	17.7	12.3	150	2500		322 080 300 113	without preliminary setup	S	CAN	C	E	D	L	V	120
Audi A3 Saloon (8Y) without preliminary setup inc. S-Line inc. AdBlue inc. Hybrid	04/20-	KIT		322 094 900 113		60	19.6	12.3	150	2500		included in the KIT 322 080 300 113	without preliminary setup	S	CAN	C	E	D	L	V	120
Audi A3 Sportback inc. Quattro, V6 3,2 l (250 HP), Facelift 06/08- models S3 04/08-: Please check if the vehicle is homologated for towing trailers by the vehicle manufacturer.	09/04-01/13			305 299 600 001		120	16.5	9.7	100	1800		305 256 300 113		S	CAN	C	E	D1	--	V	120









Audi A3 Sportback inc. Quattro, S-Line, V6 3,2 l (250 HP), Facelift 06/08- models S3 04/08-: Please check if the vehicle is homologated for towing trailers by the vehicle manufacturer. For optimal fit, order spoiler and cover at Audi dealers.	09/04-01/13			305 300 600 001		120	17.5	9.7	100	1800		305 256 300 113			S	CAN	C	E	D1	--	V	120
		KIT		305 300 900 113		120	18.5	9.7	100	1800		included in the KIT 305 256 300 113			S	CAN	C	E	D1	--	V	120
Audi A3 Sportback without preliminary setup Attention: Depending on the engine variation it may be necessary to change the cooling system of the vehicle.	02/13-06/14	KIT		317 131 900 113		60	21.0	10.3	85	2000		included in the KIT 305 406 300 113		-06/14 without preliminary setup	S	CAN	C	E	D	L1	V	150
Audi A3 Sportback without preliminary setup Please order spoiler inc. cover for bumper cutout at Audi-dealers. Attention: Depending on the engine variation it may be necessary to change the cooling system of the vehicle.	02/13-06/14	KIT		317 132 900 113		60	21.0	10.3	85	2000		included in the KIT 305 406 300 113		-06/14 without preliminary setup	S	CAN	C	E	D	L1	V	150
Audi A3 Sportback Please order spoiler inc. cover for bumper cutout at Audi-dealers. Attention: Depending on the engine variation it may be necessary to change the cooling system of the vehicle.	02/13-06/16			317 132 600 001		60	19.0	10.3	85	2000		305 403 300 113		-06/14 with preliminary setup	S	CAN	C	E	D	L1	H	45
			305 406 300 113									-06/14 without preliminary setup	S	CAN	C	E	D	L1	V	150		
			305 407 300 113									06/14- with preliminary setup	S	CAN	C	E	D	L	H	30		
			305 408 300 107								→	06/14-11/19 without preliminary setup	S	CAN	C	E	--	--	V	60		
			305 408 300 113									06/14-11/19 without preliminary setup	S	CAN	C	E	D	L	V	60		
Audi A3 Sportback without preliminary setup Please order spoiler inc. cover for bumper cutout at Audi-dealers. Attention: Depending on the engine variation it may be necessary to change the cooling system of the vehicle.	02/13-06/16	KIT		305 419 900 113		60	20.9	10.3	85	2000		included in the KIT 305 438 300 113		inc. WLC 2.0 without preliminary setup	S	CAN	C	E	D	L1	V	90













Audi

Audi A3 Sportback (8V) inc. vehicles 07/16- Attention: Depending on the engine variation it may be necessary to change the cooling system of the vehicle.	02/13-11/19		317 131 600 001		60	19.0	10.3	85	2000	305 403 300 113	-06/14 with preliminary setup	S	CAN	C	E	D	L1	H	45
										305 406 300 113	-06/14 without preliminary setup	S	CAN	C	E	D	L1	V	150
										305 407 300 113	06/14- with preliminary setup	S	CAN	C	E	D	L	H	30
										305 408 300 107 →	06/14-11/19 without preliminary setup	S	CAN	C	E	--	--	V	60
										305 408 300 113	06/14-11/19 without preliminary setup	S	CAN	C	E	D	L	V	60
Audi A3 Sportback (8V) without preliminary setup inc. vehicles 07/16- Attention: Depending on the engine variation it may be necessary to change the cooling system of the vehicle.	02/13-11/19	KIT 	305 418 900 113		60	20.9	10.3	85	2000	included in the KIT 305 438 300 113	inc. WLC 2.0 without preliminary setup	S	CAN	C	E	D	L1	V	90
Audi A3 Sportback without preliminary setup Please order spoiler inc. cover for bumper cutout at Audi-dealers. Attention: Depending on the engine variation it may be necessary to change the cooling system of the vehicle.	06/14-06/16	KIT 	305 409 900 113		60	21.0	10.3	85	2000	included in the KIT 305 408 300 113	06/14-11/19 without preliminary setup	S	CAN	C	E	D	L	V	60
Audi A3 Sportback with preliminary setup Please order spoiler inc. cover for bumper cutout at Audi-dealers. Attention: Depending on the engine variation it may be necessary to change the cooling system of the vehicle.	06/14-06/16	KIT 	317 155 900 113		60	20.5	10.3	85	2000	included in the KIT 305 407 300 113	06/14- with preliminary setup	S	CAN	C	E	D	L	H	30
Audi A3 Sportback (8V) without preliminary setup inc. vehicles 07/16- Attention: Depending on the engine variation it may be necessary to change the cooling system of the vehicle.	06/14-11/19	KIT 	305 408 900 113		60	19.0	10.3	85	2000	included in the KIT 305 408 300 113	06/14-11/19 without preliminary setup	S	CAN	C	E	D	L	V	60



























Audi A3 Sportback (8V) with preliminary setup inc. vehicles 07/16- Attention: Depending on the engine variation it may be necessary to change the cooling system of the vehicle.	06/14-11/19	KIT		317 154 900 113		60	20.5	10.3	85	2000			included in the KIT 305 407 300 113	06/14- with preliminary setup	S	CAN	C	E	D	L	H	30
Audi A3 Sportback (8V) Attention: Depending on the engine variation it may be necessary to change the cooling system of the vehicle.	07/16-11/19			305 605 600 001		60	19.4	9.0	109	2100		305 407 300 113	06/14- with preliminary setup	S	CAN	C	E	D	L	H	30	
				305 606 600 001		60	21.4	9.0	109	2100		305 408 300 107	→	06/14-11/19 without preliminary setup	S	CAN	C	E	--	--	V	60
												305 408 300 113		06/14-11/19 without preliminary setup	S	CAN	C	E	D	L	V	60
Audi A3 Sportback (8V) without preliminary setup Attention: Depending on the engine variation it may be necessary to change the cooling system of the vehicle.	07/16-11/19	KIT		305 555 900 113		60	19.4	9.0	109	2100		included in the KIT 305 408 300 113	06/14-11/19 without preliminary setup	S	CAN	C	E	D	L	V	60	
Audi A3 Sportback (8V) without preliminary setup Attention: Depending on the engine variation it may be necessary to change the cooling system of the vehicle.	07/16-11/19	KIT		305 556 900 113		60	19.4	9.0	109	2100		included in the KIT 305 407 300 113	06/14- with preliminary setup	S	CAN	C	E	D	L	H	30	
Audi A3, 3 doors front wheel drive inc. Quattro, inc. S3 04/06-, inc. V6 3,2 l, 250 HP models S3 04/08-: Please check if the vehicle is allowed for towing trailers by the car manufacturer.	05/03-04/12			321 865 600 001		60	17.0	9.4	100	1800		305 256 300 113			S	CAN	C	E	D1	--	V	120
				KIT		305 389 900 113		60	19.0	9.4	100	1800		included in the KIT 305 256 300 113			S	CAN	C	E	D1	--
Audi A3, 3 doors front wheel drive inc. Quattro, inc. S-Line and S3 04/06-, inc. V6 3,2 l, 250 HP models S3 04/08-: Please check if the vehicle is allowed for towing trailers by the car manufacturer. Please order separately spoiler inc. cover at Audi dealers.	05/03-04/12			321 885 600 001		60	17.0	9.4	100	1800		305 256 300 113			S	CAN	C	E	D1	--	V	120
				KIT		305 390 900 113		60	19.0	9.4	100	1800		included in the KIT 305 256 300 113			S	CAN	C	E	D1	--









Audi

Audi A3, 3 doors without preliminary setup inc. S-Line, exc. S3 Attention: Depending on the engine variation it may be necessary to change the cooling system of the vehicle.	05/12-06/14	KIT		317 131 900 113		60	21.0	10.3	85	2000		included in the KIT 305 406 300 113		-06/14 without preliminary setup	S	CAN	C	E	D	L1	V	150	
Audi A3, 3 doors without preliminary setup Please order spoiler inc. cover for bumper cutout at Audi-dealers. Attention: Depending on the engine variation it may be necessary to change the cooling system of the vehicle.	05/12-06/14	KIT		317 132 900 113		60	21.0	10.3	85	2000		included in the KIT 305 406 300 113		-06/14 without preliminary setup	S	CAN	C	E	D	L1	V	150	
Audi A3, 3 doors inc. S-Line, exc. S3 inc. facelift 07/16- Attention: Depending on the engine variation it may be necessary to change the cooling system of the vehicle.	05/12-11/19			317 131 600 001		60	19.0	10.3	85	2000		305 403 300 113		-06/14 with preliminary setup	S	CAN	C	E	D	L1	H	45	
												305 406 300 113		-06/14 without preliminary setup	S	CAN	C	E	D	L1	V	150	
												305 407 300 113		06/14-11/19 with preliminary setup	S	CAN	C	E	D	L	H	30	
												305 408 300 107	→	06/14- without preliminary setup	S	CAN	C	E	--	--	V	60	
												305 408 300 113		06/14- without preliminary setup	S	CAN	C	E	D	L	V	60	
Audi A3, 3 doors inc. S-Line, exc. S3 inc. facelift 07/16- Please order spoiler inc. cover for bumper cutout at Audi-dealers. Attention: Depending on the engine variation it may be necessary to change the cooling system of the vehicle.	05/12-11/19			317 132 600 001		60	19.0	10.3	85	2000		305 403 300 113		-06/14 with preliminary setup	S	CAN	C	E	D	L1	H	45	
												305 406 300 113		-06/14 without preliminary setup	S	CAN	C	E	D	L1	V	150	
												305 407 300 113		06/14-11/19 with preliminary setup	S	CAN	C	E	D	L	H	30	
												305 408 300 107	→	06/14- without preliminary setup	S	CAN	C	E	--	--	V	60	
												305 408 300 113		06/14- without preliminary setup	S	CAN	C	E	D	L	V	60	























Audi A3, 3 doors without preliminary setup inc. S-Line, exc. S3 inc. facelift 07/16- Attention: Depending on the engine variation it may be necessary to change the cooling system of the vehicle.	05/12-11/19	KIT		305 418 900 113		60	20.9	10.3	85	2000		included in the KIT 305 438 300 113	inc. WLC 2.0 without preliminary setup	S	CAN	C	E	D	L1	V	90
Audi A3, 3 doors without preliminary setup Please order spoiler inc. cover for bumper cutout at Audi-dealers. inc. S-Line, exc. S3 Attention: Depending on the engine variation it may be necessary to change the cooling system of the vehicle.	05/12-11/19	KIT		305 419 900 113		60	20.9	10.3	85	2000		included in the KIT 305 438 300 113	inc. WLC 2.0 without preliminary setup	S	CAN	C	E	D	L1	V	90
Audi A3, 3 doors without preliminary setup Please order spoiler inc. cover for bumper cutout at Audi-dealers. inc. S-Line, exc. S3 Attention: Depending on the engine variation it may be necessary to change the cooling system of the vehicle.	06/14-05/16	KIT		305 409 900 113		60	21.0	10.3	85	2000		included in the KIT 305 408 300 113	06/14- without preliminary setup	S	CAN	C	E	D	L	V	60
Audi A3, 3 doors with preliminary setup Please order spoiler inc. cover for bumper cutout at Audi-dealers. inc. S-Line, exc. S3 Attention: Depending on the engine variation it may be necessary to change the cooling system of the vehicle.	06/14-05/16	KIT		317 155 900 113		60	20.5	10.3	85	2000		included in the KIT 305 407 300 113	06/14-11/19 with preliminary setup	S	CAN	C	E	D	L	H	30
Audi A3, 3 doors without preliminary setup inc. S-Line, exc. S3 inc. facelift 07/16- Attention: Depending on the engine variation it may be necessary to change the cooling system of the vehicle.	06/14-11/19	KIT		305 408 900 113		60	19.0	10.3	85	2000		included in the KIT 305 408 300 113	06/14- without preliminary setup	S	CAN	C	E	D	L	V	60
Audi A3, 3 doors with preliminary setup inc. S-Line, exc. S3 inc. facelift 07/16- Attention: Depending on the engine variation it may be necessary to change the cooling system of the vehicle.	06/14-11/19	KIT		317 154 900 113		60	20.5	10.3	85	2000		included in the KIT 305 407 300 113	06/14-11/19 with preliminary setup	S	CAN	C	E	D	L	H	30



























Audi

Audi A4 Allroad Quattro B8 Attention: Depending on the engine variation it may be necessary to change the cooling system of the vehicle. RECEPTION TUBE FOR TOWBALL VISIBLE	06/09-12/15			305 571 600 001		90	25.1	11.1	90	2100		305 214 300 113			S	CAN	C	E	D	L1	H	60	
		KIT		305 571 900 113		90	26.8	11.1	90	2100		included in the KIT 305 214 300 113			S	CAN	C	E	D	L1	H	60	
Audi A4 Allroad Quattro B9	01/16-			305 450 600 001		90	24.0	11.2	85	2100		305 417 300 113	→		S	A	C1	E2	D	L1	H	60	
				305 447 600 001		90	25.5	11.2	85	2100		305 437 300 113			S	CAN	C	E	D	L	H	60	
				305 447 300 113											S	CAN	C	E	D	L1	H	60	
		KIT		305 450 900 113	→		90	28.0	11.2	85	2100		included in the KIT 305 417 300 113	→		S	A	C1	E2	D	L1	H	60
		KIT		305 531 900 113			90	25.1	11.2	85	2100		included in the KIT 305 437 300 113			S	CAN	C	E	D	L	H	60
		KIT		305 447 900 113	→		90	29.0	11.2	85	2100		included in the KIT 305 417 300 113	→		S	A	C1	E2	D	L1	H	60
		KIT		305 532 900 113		90	26.6	11.2	85	2100		included in the KIT 305 437 300 113			S	CAN	C	E	D	L	H	60	
Audi A4 Avant inc. Quattro + S4 exc. RS 4	01/96-11/01			305 179 600 001		150	18.0	10.1	75	1800													
Audi A4 Avant B6 Quattro and S-Line, exc. S4	11/01-11/04			305 205 600 001		120	18.5	10.3	85	2000		305 215 300 113			S	CAN	C	E	D1	--	H	75	
				305 206 600 001		120	20.0	10.3	85	2000													
		KIT		305 205 900 113		120	20.5	10.3	85	2000		included in the KIT 305 215 300 113			S	CAN	C	E	D1	--	H	75	
		KIT		305 206 900 113		120	22.0	10.3	85	2000		included in the KIT 305 215 300 113			S	CAN	C	E	D1	--	H	75	

Audi A4 Avant B7 inc. Quattro, S-line exc. RS4/S4	11/04-05/08		305 301 600 001		120	20.0	10.4	100	2000	305 210 300 113			S	CAN	C	E	D1	L1	V	105
			305 302 600 001		120	20.0	10.4	100	2000											
	KIT		305 301 900 113		120	22.0	10.4	100	2000	included in the KIT 305 210 300 113			S	CAN	C	E	D1	L1	V	105
	KIT		305 302 900 113		120	22.0	10.4	100	2000	included in the KIT 305 210 300 113			S	CAN	C	E	D1	L1	V	105
Audi A4 Avant B8 inc. S4, S-Line, Quattro exc.RS Attention: Depending on the engine variation it may be necessary to change the cooling system of the vehicle.	04/08-11/15		305 443 600 001		90	19.0	11.1	90	2000	305 214 300 113	04/08-12/15 B8 only for vehicles without ACC inc. WLC 2.0		S	CAN	C	E	D	L1	H	60
			305 571 300 113		90	19.0	11.1	90	2000	305 571 300 113										
	KIT		305 324 900 113		90	21.0	11.1	90	2000	included in the KIT 305 214 300 113			S	CAN	C	E	D	L1	H	60
Audi A4 Avant B8 inc. S4, S-Line, Quattro Sport exc.RS For S4 please order extended socket holder, order no. 921740650001. Attention: Depending on the engine variation it may be necessary to change the cooling system of the vehicle. RECEPTION TUBE FOR TOWBALL VISIBLE	04/08-11/15		305 571 600 001		90	25.1	11.1	90	2100	305 214 300 113	04/08-12/15 B8 only for vehicles without ACC inc. WLC 2.0		S	CAN	C	E	D	L1	H	60
			305 571 300 113		90	25.1	11.1	90	2100	305 571 300 113										
KIT		305 571 900 113		90	26.8	11.1	90	2100	included in the KIT 305 214 300 113			S	CAN	C	E	D	L1	H	60	

























Audi





















Audi A4 Avant B9 exc. CNG exc. RS4	05/15-			305 450 600 001		90	24.0	11.2	85	2100		305 417 300 113	→		S	A	C1	E2	D	L1	H	60	
				305 447 600 001		90	25.5	11.2	85	2100		305 437 300 113			S	CAN	C	E	D	L	H	60	
					305 447 300 113								305 447 300 113			S	CAN	C	E	D	L1	H	60
		KIT		305 450 900 113	→		90	28.0	11.2	85	2100		included in the KIT 305 417 300 113	→		S	A	C1	E2	D	L1	H	60
		KIT		305 531 900 113			90	25.1	11.2	85	2100		included in the KIT 305 437 300 113			S	CAN	C	E	D	L	H	60
		KIT		305 447 900 113	→		90	29.0	11.2	85	2100		included in the KIT 305 417 300 113	→		S	A	C1	E2	D	L1	H	60
		KIT		305 532 900 113			90	26.6	11.2	85	2100		included in the KIT 305 437 300 113			S	CAN	C	E	D	L	H	60
		Audi A4 Avant B9 for vehicles without preliminary setup exc. S-Line 05/19- exc. CNG inc. AdBlue	05/15-	KIT		305 627 900 113		90		10.7	90	2100		included in the KIT 300 001 300 153		not available individually	S	CAN	C	E	D	L1	H
Audi A4 Convertible B6, exc. S4	05/02-05			305 205 600 001		120	18.5	10.3	85	2000		305 215 300 113			S	CAN	C	E	D1	--	H	75	
		KIT		305 205 900 113			120	20.5	10.3	85	2000		included in the KIT 305 215 300 113			S	CAN	C	E	D1	--	H	75
Audi A4 Convertible B6 inc. S-Line, exc. S4	05/02-05			305 206 600 001		120	20.0	10.3	85	2000		305 215 300 113			S	CAN	C	E	D1	--	H	75	
		KIT		305 206 900 113			120	22.0	10.3	85	2000		included in the KIT 305 215 300 113			S	CAN	C	E	D1	--	H	75

Audi A4 Convertible B7 inc. S-line exc. RS4/S4	10/05-03/09			305 301 600 001		120	20.0	10.4	100	2000	305 210 300 113			S	CAN	C	E	D1	L1	V	105	
				305 302 600 001		120	20.0	10.4	100	2000												
		KIT		305 301 900 113		120	22.0	10.4	100	2000												included in the KIT 305 210 300 113
		KIT		305 302 900 113		120	22.0	10.4	100	2000												included in the KIT 305 210 300 113
Audi A4 Saloon B5 inc. Quattro + S4	11/94-11/00			305 179 600 001		150	18.0	10.1	75	1800	300 078 300 113	03/99-	--	FRE	--	--	D1	L1	V			
Audi A4 Saloon B6 Quattro and S-Line, exc. S4	11/00-11/04			305 205 600 001		120	18.5	10.3	85	2000	305 215 300 113			S	CAN	C	E	D1	--	H	75	
				305 206 600 001		120	20.0	10.3	85	2000												
		KIT		305 205 900 113		120	20.5	10.3	85	2000	included in the KIT 305 215 300 113											
		KIT		305 206 900 113		120	22.0	10.3	85	2000	included in the KIT 305 215 300 113											
Audi A4 Saloon B7 inc. Quattro, S-line exc. RS4/S4	11/04-09/07			305 301 600 001		120	20.0	10.4	100	2000	305 210 300 113			S	CAN	C	E	D1	L1	V	105	
				305 302 600 001		120	20.0	10.4	100	2000												
		KIT		305 301 900 113		120	22.0	10.4	100	2000	included in the KIT 305 210 300 113											
		KIT		305 302 900 113		120	22.0	10.4	100	2000	included in the KIT 305 210 300 113											

















Audi























Audi

Audi A4 Saloon B8 inc. S4, S-Line, Quattro exc.RS Attention: Depending on the engine variation it may be necessary to change the cooling system of the vehicle.	09/07-11/15		305 443 600 001		90	19.0	11.1	90	2000	305 214 300 113	09/07-12/15 B8 only for vehicles without ACC inc. WLC 2.0	S	CAN	C	E	D	L1	H	60		
		KIT		305 324 900 113		90	21.0	11.1	90	2000		included in the KIT 305 214 300 113	S	CAN	C	E	D	L1	H	60	
Audi A4 Saloon B8 inc. S4, S-Line, Quattro Sport exc.RS For S4 please order extended socket holder, order no. 905323608001. Attention: Depending on the engine variation it may be necessary to change the cooling system of the vehicle. RECEPTION TUBE FOR TOWBALL VISIBLE	09/07-11/15		305 571 600 001		90	25.1	11.1	90	2100	305 214 300 113	09/07-12/15 B8 only for vehicles without ACC inc. WLC 2.0	S	CAN	C	E	D	L1	H	60		
		KIT		305 571 900 113		90	26.8	11.1	90	2100		included in the KIT 305 214 300 113	S	CAN	C	E	D	L1	H	60	
Audi A4 Saloon B9 exc. CNG	05/15-		305 450 600 001		90	24.0	11.2	85	2100	305 417 300 113	→	S	A	C1	E2	D	L1	H	60		
			305 447 600 001		90	25.5	11.2	85	2100	305 437 300 113		S	CAN	C	E	D	L	H	60		
			305 447 300 113		90	25.5	11.2	85	2100	305 447 300 113		S	CAN	C	E	D	L1	H	60		
		KIT		305 450 900 113	→		90	28.0	11.2	85	2100	included in the KIT 305 417 300 113	→	S	A	C1	E2	D	L1	H	60
		KIT		305 531 900 113		90	25.1	11.2	85	2100	included in the KIT 305 437 300 113	S	CAN	C	E	D	L	H	60		
		KIT		305 447 900 113	→		90	29.0	11.2	85	2100	included in the KIT 305 417 300 113	→	S	A	C1	E2	D	L1	H	60
KIT		305 532 900 113		90	26.6	11.2	85	2100	included in the KIT 305 437 300 113	S	CAN	C	E	D	L	H	60				
Audi A4 Saloon B9 for vehicles without preliminary setup exc. S-Line 05/19- exc. CNG inc. AdBlue	05/15-	KIT		305 627 900 113		90		10.7	90	2100	included in the KIT 300 001 300 153	not available individually	S	CAN	C	E	D	L1	H	60	

Audi A5 Convertible B8 inc. S5, S-Line, Quattro exc.RS Attention: Depending on the engine variation it may be necessary to change the cooling system of the vehicle.	09-09/16		305 443 600 001		90	19.0	11.1	90	2000		305 214 300 113		03/09-03/17 B8 only for vehicles without ACC inc. WLC 2.0	S	CAN	C	E	D	L1	H	60	
		KIT		305 324 900 113		90	21.0	11.1	90	2000		included in the KIT 305 214 300 113			S	CAN	C	E	D	L1	H	60
Audi A5 Convertible B8 inc. S5, S-Line, Quattro Sport exc.RS For S5 please order extended socket holder, order no. 905323608001. Attention: Depending on the engine variation it may be necessary to change the cooling system of the vehicle. RECEPTION TUBE FOR TOWBALL VISIBLE	09-09/16		305 571 600 001		90	25.1	11.1	90	2100		305 214 300 113		03/09-03/17 B8 only for vehicles without ACC inc. WLC 2.0	S	CAN	C	E	D	L1	H	60	
		KIT		305 571 900 113		90	26.8	11.1	90	2100		included in the KIT 305 214 300 113			S	CAN	C	E	D	L1	H	60
Audi A5 Convertible (F57) exc. CNG	09/16-		305 450 600 001		90	24.0	11.2	85	2100		305 417 300 113	→		S	A	C1	E2	D	L1	H	60	
			305 447 600 001		90	25.5	11.2	85	2100		305 437 300 113			S	CAN	C	E	D	L	H	60	
											305 447 300 113			S	CAN	C	E	D	L1	H	60	
		KIT		305 450 900 113	→ 	90	28.0	11.2	85	2100		included in the KIT 305 417 300 113	→		S	A	C1	E2	D	L1	H	60
		KIT		305 531 900 113		90	25.1	11.2	85	2100		included in the KIT 305 437 300 113			S	CAN	C	E	D	L	H	60
		KIT		305 447 900 113	→ 	90	29.0	11.2	85	2100		included in the KIT 305 417 300 113	→		S	A	C1	E2	D	L1	H	60
KIT		305 532 900 113		90	26.6	11.2	85	2100		included in the KIT 305 437 300 113			S	CAN	C	E	D	L	H	60		



























Audi



























Audi A5 Coupé B8 inc. S5, S-Line, Quattro exc.RS Attention: Depending on the engine variation it may be necessary to change the cooling system of the vehicle.	06/07-09/16		305 443 600 001		90	19.0	11.1	90	2000		305 214 300 113	06/07-10/16 B8 only for vehicles without ACC inc. WLC 2.0	S	CAN	C	E	D	L1	H	60		
											305 571 300 113		S	CAN	C	E	D	L1	H	45		
Audi A5 Coupé B8 inc. S5, S-Line, Quattro Sport exc.RS For S5 please order extended socket holder, order no. 905323608001. Attention: Depending on the engine variation it may be necessary to change the cooling system of the vehicle. RECEPTION TUBE FOR TOWBALL VISIBLE	06/07-09/16		305 571 600 001		90	25.1	11.1	90	2100		305 214 300 113	06/07-10/16 B8 only for vehicles without ACC inc. WLC 2.0	S	CAN	C	E	D	L1	H	60		
											305 571 300 113		S	CAN	C	E	D	L1	H	45		
Audi A5 Coupé B9 exc. CNG exc. RS5	09/16-		305 450 600 001		90	24.0	11.2	85	2100		305 417 300 113	→	S	A	C1	E2	D	L1	H	60		
			305 447 600 001		90	25.5	11.2	85	2100		305 437 300 113		S	CAN	C	E	D	L	H	60		
											305 447 300 113		S	CAN	C	E	D	L1	H	60		
		KIT		305 450 900 113	→		90	28.0	11.2	85	2100		included in the KIT 305 417 300 113	→	S	A	C1	E2	D	L1	H	60
		KIT		305 531 900 113			90	25.1	11.2	85	2100		included in the KIT 305 437 300 113		S	CAN	C	E	D	L	H	60
		KIT		305 447 900 113	→		90	29.0	11.2	85	2100		included in the KIT 305 417 300 113	→	S	A	C1	E2	D	L1	H	60
		KIT		305 532 900 113			90	26.6	11.2	85	2100		included in the KIT 305 437 300 113		S	CAN	C	E	D	L	H	60

Audi A5 Sportback B8 inc. S5, S-Line, Quattro exc.RS Attention: Depending on the engine variation it may be necessary to change the cooling system of the vehicle.	09/09-04/17		305 443 600 001		90	19.0	11.1	90	2000	305 214 300 113	09/09-01/17 B8 only for vehicles without ACC inc. WLC 2.0	S	CAN	C	E	D	L1	H	60			
		KIT		305 324 900 113		90	21.0	11.1	90	2000		included in the KIT 305 214 300 113	S	CAN	C	E	D	L1	H	60		
Audi A5 Sportback B8 inc. S5, S-Line, Quattro Sport exc.RS For S5 please order extended socket holder, order no. 905323608001. Attention: Depending on the engine variation it may be necessary to change the cooling system of the vehicle. RECEPTION TUBE FOR TOWBALL VISIBLE	09/09-04/17		305 571 600 001		90	25.1	11.1	90	2100	305 214 300 113	09/09-01/17 B8 only for vehicles without ACC inc. WLC 2.0	S	CAN	C	E	D	L1	H	60			
		KIT		305 571 900 113		90	26.8	11.1	90	2100		included in the KIT 305 214 300 113	S	CAN	C	E	D	L1	H	60		
Audi A5 Sportback B9 exc. CNG exc. RS5	05/17-		305 450 600 001		90	24.0	11.2	85	2100	305 417 300 113	→	S	A	C1	E2	D	L1	H	60			
			305 447 600 001		90	25.5	11.2	85	2100	305 437 300 113		S	CAN	C	E	D	L	H	60			
			305 447 300 113							305 447 300 113		S	CAN	C	E	D	L1	H	60			
		KIT		305 450 900 113	→		90	28.0	11.2	85		2100	included in the KIT 305 417 300 113	→	S	A	C1	E2	D	L1	H	60
		KIT		305 531 900 113			90	25.1	11.2	85		2100	included in the KIT 305 437 300 113		S	CAN	C	E	D	L	H	60
		KIT		305 447 900 113	→		90	29.0	11.2	85		2100	included in the KIT 305 417 300 113	→	S	A	C1	E2	D	L1	H	60
KIT		305 532 900 113			90	26.6	11.2	85	2100	included in the KIT 305 437 300 113		S	CAN	C	E	D	L	H	60			
Audi A6 Allroad C7 Please order spoiler at Audi dealers.	06/12-10/14	KIT		305 407 900 113		90	22.0	12.6	100	2500	included in the KIT 305 385 300 113	-10/14	S	CAN	C	E	D	L1	H	45		
Audi A6 Allroad C7 Please order spoiler at Audi dealers.	06/12-09/18		305 407 600 001			90	20.0	12.6	100	2500	305 385 300 113	-10/14	S	CAN	C	E	D	L1	H	45		
											305 387 300 113	10/14-	S	CAN	C	E	D	L	H	60		





























Audi





























Audi

Audi A6 Allroad (C8) inc. AdBlue	10/18-			305 601 600 001		90	26.1	12.6	150	2500		305 486 300 113			S	CAN	C	E	D	L	H	90
												305 601 300 113			S	CAN	C	E	D	L1	H	45
		KIT		305 601 900 113		90	27.9	12.6	150	2500		included in the KIT 305 486 300 113			S	CAN	C	E	D	L	H	90
Audi A6 Allroad C8 inc. AdBlue	10/18-	KIT		305 613 900 113		90	31.0	12.6	150	2500		included in the KIT 300 007 300 153		not available individually	S	CAN	--	E1	D	L1	H	60
Audi A6 Avant with steel springs inc. S6 and Quattro, exc. RS6, exc. S-Line	03/05-09/11			305 564 600 001		60	25.8	12.0	90	2200		305 268 300 113			S	CAN	C	E	D	L1	H	45
				305 565 600 001		60	25.8	12.0	90	2400						S	CAN	C	E	D	L1	H
		KIT		305 269 900 113		120	27.0	12.0	90	2200		included in the KIT 305 268 300 113			S	CAN	C	E	D	L1	H	45
		KIT		305 565 900 113		60	27.6	12.0	90	2400		included in the KIT 305 268 300 113			S	CAN	C	E	D	L1	H	45
Audi A6 Avant exc. RS6 inc. Quattro, S-line	09/11-10/14	KIT		305 428 900 113		90	22.0	12.6	100	2500		included in the KIT 305 385 300 113		-10/14	S	CAN	C	E	D	L1	H	45
Audi A6 Avant exc. RS6 inc. Quattro, S-line	09/11-10/14	KIT		305 429 900 113		90	23.0	12.6	100	2500		included in the KIT 305 385 300 113		-10/14	S	CAN	C	E	D	L1	H	45
Audi A6 Avant exc. RS6 inc. Quattro, S-line	09/11-08/18			305 428 600 001		90	20.0	12.6	100	2500		305 385 300 113		-10/14	S	CAN	C	E	D	L1	H	45
				305 429 600 001		90	21.0	12.6	100	2500		305 387 300 113		10/14-08/18	S	CAN	C	E	D	L	H	60
Audi A6 Avant exc. RS6 inc. Quattro, S-line	10/14-08/18	KIT		305 438 900 113		90	22.0	12.6	100	2500		included in the KIT 305 387 300 113		10/14-08/18	S	CAN	C	E	D	L	H	60
		KIT		305 439 900 113		90	23.0	12.6	100	2500		included in the KIT 305 387 300 113		10/14-08/18	S	CAN	C	E	D	L	H	60

Audi A6 Avant C8 inc. AdBlue exc. RS6	05/18-	KIT		305 557 900 113		90	22.6	12.6	150	2500		included in the KIT 305 486 300 113	05/18-	S	CAN	C	E	D	L	H	90
		KIT		305 558 900 113		90	25.2	12.6	150	2500		included in the KIT 305 486 300 113	05/18-	S	CAN	C	E	D	L	H	90
Audi A6 Avant (C8) inc. AdBlue exc. RS6	05/18-			305 602 600 001		90	23.6	12.6	150	2500		305 486 300 113 305 601 300 113	05/18-	S	CAN	C	E	D	L	H	90
														S	CAN	C	E	D	L1	H	45
Audi A6 Avant (C8) inc. AdBlue exc. RS6	05/18-			305 603 600 001		90	26.3	12.6	150	2500		305 486 300 113 305 601 300 113	05/18-	S	CAN	C	E	D	L	H	90
														S	CAN	C	E	D	L1	H	45
Audi A6 Avant C8 inc. AdBlue exc. RS	05/18-	KIT		305 613 900 113		90	31.0	12.6	150	2500		included in the KIT 300 007 300 153	not available individually	S	CAN	--	E1	D	L1	H	60
Audi A6 Saloon with steel springs inc. S6 and Quattro, exc. RS6, exc. S-Line	04/04-03/11			305 565 600 001		60	25.8	12.0	90	2400		305 268 300 113		S	CAN	C	E	D	L1	H	45
		KIT		305 269 900 113		120	27.0	12.0	90	2200		included in the KIT 305 268 300 113		S	CAN	C	E	D	L1	H	45
		KIT		305 565 900 113		60	27.6	12.0	90	2400		included in the KIT 305 268 300 113		S	CAN	C	E	D	L1	H	45
Audi A6 Saloon with steel springs inc. S6 and Quattro, exc. RS6, nicht für S-Line	03/05-09/11			305 564 600 001		60	25.8	12.0	90	2200		305 268 300 113		S	CAN	C	E	D	L1	H	45
Audi A6 Saloon	03/11-10/14	KIT		305 428 900 113		90	22.0	12.6	100	2500		included in the KIT 305 385 300 113	-10/14	S	CAN	C	E	D	L1	H	45
		KIT		305 429 900 113		90	23.0	12.6	100	2500		included in the KIT 305 385 300 113	-10/14	S	CAN	C	E	D	L1	H	45
Audi A6 Saloon	03/11-02/18			305 428 600 001		90	20.0	12.6	100	2500		305 385 300 113	-10/14	S	CAN	C	E	D	L1	H	45
				305 429 600 001		90	21.0	12.6	100	2500		305 387 300 113	10/14-02/18	S	CAN	C	E	D	L	H	60

























Audi

























Audi A6 Saloon	10/14-02/18	KIT		305 438 900 113		90	22.0	12.6	100	2500	included in the KIT 305 387 300 113	10/14-02/18	S	CAN	C	E	D	L	H	60
		KIT		305 439 900 113		90	23.0	12.6	100	2500	included in the KIT 305 387 300 113	10/14-02/18	S	CAN	C	E	D	L	H	60
Audi A6 Saloon C8 inc. AdBlue	02/18-	KIT		305 557 900 113		90	22.6	12.6	150	2500	included in the KIT 305 486 300 113	02/18-	S	CAN	C	E	D	L	H	90
		KIT		305 558 900 113		90	25.2	12.6	150	2500	included in the KIT 305 486 300 113	02/18-	S	CAN	C	E	D	L	H	90
		KIT		305 613 900 113		90	31.0	12.6	150	2500	included in the KIT 300 007 300 153	not available individually	S	CAN	--	E1	D	L1	H	60
Audi A6 Saloon (C8) inc. AdBlue	02/18-			305 602 600 001		90	23.6	12.6	150	2500	305 486 300 113	02/18-	S	CAN	C	E	D	L	H	90
				305 603 600 001		90	26.3	12.6	150	2500	305 601 300 113		S	CAN	C	E	D	L1	H	45
Audi A7 Sportback inc. S-line + S7	10/10-10/14	KIT		305 428 900 113		90	22.0	12.6	100	2500	included in the KIT 305 385 300 113	-10/14	S	CAN	C	E	D	L1	H	45
		KIT		305 429 900 113		90	23.0	12.6	100	2500	included in the KIT 305 385 300 113	-10/14	S	CAN	C	E	D	L1	H	45
Audi A7 Sportback inc. S-line + S7	10/10-01/18			305 428 600 001		90	20.0	12.6	100	2500	305 385 300 113	-10/14	S	CAN	C	E	D	L1	H	45
				305 429 600 001		90	21.0	12.6	100	2500	305 387 300 113	10/14-01/18	S	CAN	C	E	D	L	H	60
Audi A7 Sportback inc. S-line + S7	10/14-01/18	KIT		305 438 900 113		90	22.0	12.6	100	2500	included in the KIT 305 387 300 113	10/14-01/18	S	CAN	C	E	D	L	H	60
		KIT		305 439 900 113		90	23.0	12.6	100	2500	included in the KIT 305 387 300 113	10/14-01/18	S	CAN	C	E	D	L	H	60
Audi A7 Sportback C8 inc. AdBlue inc. Hybrid exc. RS6	04/18-			305 602 600 001		90	23.6	12.6	150	2500	305 486 300 113		S	CAN	C	E	D	L	H	90
											305 601 300 113		S	CAN	C	E	D	L1	H	45

Audi A7 Sportback C8 inc. AdBlue inc. Hybrid exc. RS6	04/18-			305 603 600 001		90	26.3	12.6	150	2500		305 486 300 113			S	CAN	C	E	D	L	H	90	
												305 601 300 113			S	CAN	C	E	D	L1	H	45	
		KIT		305 557 900 113		90	22.6	12.6	150	2500		included in the KIT 305 486 300 113			S	CAN	C	E	D	L	H	90	
		KIT		305 558 900 113		90	25.2	12.6	150	2500		included in the KIT 305 486 300 113			S	CAN	C	E	D	L	H	90	
Audi A8	03/10-10/17			305 384 600 001		60	26.0	12.6	100	2200		305 384 300 113	-10/13		S	CAN	C	E	D	L1	H	60	
												305 391 300 113	11/13-		S	CAN	C	E	D	L	H		
Audi-E-Tron GEN inc. Sportback	09/18-11/22			305 600 600 001		75	19.3	11.4	135	1800		305 437 300 113	09/18-11/22		S	CAN	C	E	D	L	H	60	
			KIT		305 600 900 113		75	20.4	11.4	135	1800		included in the KIT 305 437 300 113	09/18-11/22		S	CAN	C	E	D	L	H	60
Audi Q2	11/16-			317 131 600 001		60	19.0	10.3	85	2000		305 407 300 113	with preliminary setup		S	CAN	C	E	D	L	H	30	
					317 132 600 001		60	19.0	10.3	85	2000		305 408 300 107	without preliminary setup	→	S	CAN	C	E	--	--	V	60
												305 408 300 113	without preliminary setup		S	CAN	C	E	D	L	V	60	
Audi Q2 without preliminary setup	11/16-	KIT		305 408 900 113		60	19.0	10.3	85	2000		included in the KIT 305 408 300 113	without preliminary setup		S	CAN	C	E	D	L	V	60	
		KIT		305 418 900 113		60	20.9	10.3	85	2000		included in the KIT 305 438 300 113	inc. WLC 2.0 without preliminary setup		S	CAN	C	E	D	L1	V	90	
		KIT		305 409 900 113		60	21.0	10.3	85	2000		included in the KIT 305 408 300 113	without preliminary setup		S	CAN	C	E	D	L	V	60	
		KIT		305 419 900 113		60	20.9	10.3	85	2000		included in the KIT 305 438 300 113	inc. WLC 2.0 without preliminary setup		S	CAN	C	E	D	L1	V	90	
Audi Q2 with preliminary setup	11/16-	KIT		317 154 900 113		60	20.5	10.3	85	2000		included in the KIT 305 407 300 113	with preliminary setup		S	CAN	C	E	D	L	H	30	
		KIT		317 155 900 113		60	20.5	10.3	85	2000		included in the KIT 305 407 300 113	with preliminary setup		S	CAN	C	E	D	L	H	30	























Audi









Audi

Audi Q3 inc. S-line, inc. Quattro RS Vehicles from year 2015- require a new cover with cut-out. Please order from the Audi dealer.	09/11-06/18			305 421 600 001		90	19.0	12.0	100	2500		305 410 300 113	→	-06/18	S	CAN	C	E	D	L1	V	120	
				305 423 600 001		90	21.0	12.0	140	2500													
		KIT		305 421 900 113		90	21.0	12.0	100	2500		included in the KIT 305 410 300 113	→	-06/18	S	CAN	C	E	D	L1	V	120	
		KIT		305 423 900 113		90	23.0	12.0	140	2500		included in the KIT 305 410 300 113	→	-06/18	S	CAN	C	E	D	L1	V	120	
Audi Q3 F3B inc. S-Line	07/18-			344 121 600 001		60	14.0	12.3	150	2500		305 407 300 113		with preliminary setup	S	CAN	C	E	D	L	H	30	
				344 120 600 001		60	16.6	12.3	150	2500		305 408 300 107	→	without preliminary setup	S	CAN	C	E	--	--	V	60	
												305 408 300 113		without preliminary setup	S	CAN	C	E	D	L	V	60	
Audi Q3 F3B without preliminary setup inc. S-Line	07/18-	KIT		344 121 900 113		60	16.0	12.3	150	2500		included in the KIT 305 438 300 113		inc. WLC 2.0 without preliminary setup	S	CAN	C	E	D	L1	V	90	
		KIT		344 120 900 113		60	18.5	12.3	150	2500		included in the KIT 305 438 300 113		inc. WLC 2.0 without preliminary setup	S	CAN	C	E	D	L1	V	90	
Audi Q3 F3B with preliminary setup inc. S-Line	07/18-	KIT		344 071 900 113		60	15.5	12.3	150	2500		included in the KIT 305 407 300 113		with preliminary setup	S	CAN	C	E	D	L	H	30	
		KIT		344 070 900 113		60	18.7	12.3	150	2500		included in the KIT 305 407 300 113		with preliminary setup	S	CAN	C	E	D	L	H	30	
Audi Q3 Sportback F3N inc. S-Line	06/19-			344 121 600 001		60	14.0	12.3	150	2500		305 407 300 113		with preliminary setup	S	CAN	C	E	D	L	H	30	
												305 408 300 107	→		S	CAN	C	E	--	--	V	60	
													305 408 300 113		without preliminary setup	S	CAN	C	E	D	L	V	60
Audi Q3 Sportback F3N without preliminary setup inc. S-Line	06/19-	KIT		344 121 900 113		60	16.0	12.3	150	2500		included in the KIT 305 438 300 113		inc. WLC 2.0 without preliminary setup	S	CAN	C	E	D	L1	V	90	











Audi Q3 Sportback F3N with preliminary setup inc. S-Line	06/19-	KIT		344 071 900 113		60	15.5	12.3	150	2500		included in the KIT 305 407 300 113		with preliminary setup	S	CAN	C	E	D	L	H	30	
		KIT		344 070 900 113		60	18.7	12.3	150	2500		included in the KIT 305 407 300 113		with preliminary setup	S	CAN	C	E	D	L	H	30	
Audi Q3 Sportback F3N inc. S-Line	06/19-			344 120 600 001		60	16.6	12.3	150	2500		305 407 300 113	→	with preliminary setup	S	CAN	C	E	D	L	H	30	
											305 408 300 107	S		CAN	C	E	--	--	V	60			
												305 408 300 113		S	CAN	C	E	D	L	V	60		
Audi Q3 Sportback F3N without preliminary setup inc. S-Line	06/19-	KIT		344 120 900 113		60	18.5	12.3	150	2500		included in the KIT 305 438 300 113		inc. WLC 2.0 without preliminary setup	S	CAN	C	E	D	L1	V	90	
Audi Q5 inc. S-Line, inc. SQ5 Attention: Depending on the engine variation it may be necessary to change the cooling system of the vehicle.	10/08-05/16			305 411 600 001		90	21.0	12.1	100	2400		305 216 300 113			S	CAN	C	E	D	L1	H	60	
				327 068 600 001		90	21.0	12.1	100	2400													
		KIT		305 351 900 113		90	23.0	12.1	100	2400		included in the KIT 305 216 300 113			S	CAN	C	E	D	L1	H	60	
		KIT		305 412 900 113		90	26.0	12.1	100	2400		included in the KIT 305 216 300 113			S	CAN	C	E	D	L1	H	60	
Audi Q5 (FYG,FYB) inc. SQ5 inc. Plugin Hybrid	06/16-			305 579 600 001		60	20.3	12.3	150	2400		305 437 300 113		inc. Hybrid	S	CAN	C	E	D	L	H	60	
				305 580 600 001		60	23.0	12.3	150	2400		305 447 300 113			S	CAN	C	E	D	L1	H	60	
		KIT		305 579 900 113		60	21.9	12.3	150	2400		included in the KIT 305 437 300 113		inc. Hybrid	S	CAN	C	E	D	L	H	60	
		KIT		305 580 900 113		60	24.6	12.3	150	2400		included in the KIT 305 437 300 113		inc. Hybrid	S	CAN	C	E	D	L	H	60	









Audi

Audi Q5 Sportback (FYT) inc. SQ5 inc. S-Line inc. Plugin Hybrid inc. AdBlue	10/20-			305 579 600 001		60	20.3	12.3	150	2400		305 437 300 113		10/20-	S	CAN	C	E	D	L	H	60	
				305 580 600 001		60	23.0	12.3	150	2400		305 447 300 113			S	CAN	C	E	D	L1	H	60	
		KIT		305 579 900 113		60	21.9	12.3	150	2400		included in the KIT 305 437 300 113		10/20-	S	CAN	C	E	D	L	H	60	
		KIT		305 580 900 113		60	24.6	12.3	150	2400		included in the KIT 305 437 300 113		10/20-	S	CAN	C	E	D	L	H	60	
Audi Q7 inc. S-Line Please order separately spoiler at Audi dealer.	01/06-07/15			305 415 600 001		120	34.0	16.4	140	3500		305 500 300 001	→	Additional kit for vehicles without electrical tailgate	S							H	
					305 500 300 113									for vehicles with electric tailgate	S	CAN	C	E	D	L1	H	60	
		KIT		305 314 900 113		120	36.0	16.4	140	3500		included in the KIT 305 500 300 113		for vehicles with electric tailgate	S	CAN	C	E	D	L1	H	60	
											305 500 300 001	→	Additional kit for vehicles without electrical tailgate	S							H		
Audi Q7 4MB,4MG inc. Q7 3.0 TDI e-tron	07/15-			305 437 600 001		90	21.0	16.4	140	3500		305 417 300 113	→		S	A	C1	E2	D	L1	H	60	
												305 437 300 113			S	CAN	C	E	D	L	H	60	
											305 447 300 113			S	CAN	C	E	D	L1	H	60		
		KIT		305 544 900 113		90	22.1	16.4	140	3500		included in the KIT 305 437 300 113			S	CAN	C	E	D	L	H	60	
Audi Q7 inc. Q7 3.0 TDI e-tron	07/15-	KIT		305 437 900 113	→ 	90	23.7	16.4	140	3500		included in the KIT 305 417 300 113	→		S	A	C1	E2	D	L1	H	60	
Audi Q8 4MN exc. Q8 e-tron	02/18-			322 064 600 001		60	27.0	15.7	191	3500		305 437 300 113			S	CAN	C	E	D	L	H	60	
												305 447 300 113			S	CAN	C	E	D	L1	H	60	
		KIT		322 064 900 113		60	28.0	15.7	191	3500		included in the KIT 305 437 300 113			S	CAN	C	E	D	L	H	60	























Audi Q8 E-tron GEG	11/22-			305 600 600 001		75	19.3	11.4	135	1800		305 437 300 113	11/22-	S	CAN	C	E	D	L	H	60		
												305 447 300 113	11/22- 2.0	inc. WLC	S	CAN	C	E	D	L1	H	60	
		KIT		305 600 900 113		75	20.4	11.4	135	1800		included in the KIT 305 437 300 113	11/22-	S	CAN	C	E	D	L	H	60		
Audi Q8 E-tron Sportback GET	11/22-			305 600 600 001		75	19.3	11.4	135	1800		305 437 300 113	11/22-	S	CAN	C	E	D	L	H	60		
												305 447 300 113	11/22- 2.0	inc. WLC	S	CAN	C	E	D	L1	H	60	
		KIT		305 600 900 113		75	20.4	11.4	135	1800		included in the KIT 305 437 300 113	11/22-	S	CAN	C	E	D	L	H	60		
Audi TT is not permitted to tow by the vehicle manufacturer.																							



















BMW



BMW 1 Series Convertible E88 135i is not homologated for towing.	01/08-01/14			303 323 600 001		60	20.0	8.0	90	1400		303 460 300 113			S	CAN	--	E2	D	L1	H	60
		KIT		303 323 900 113		60	22.0	8.0	90	1400		included in the KIT 303 460 300 113			S	CAN	--	E2	D	L1	H	60
BMW 1 Series Coupé E82 135i is not homologated for towing.	11/07-01/14			303 323 600 001		60	20.0	8.0	90	1400		303 460 300 113			S	CAN	--	E2	D	L1	H	60
		KIT		303 323 900 113		60	22.0	8.0	90	1400		included in the KIT 303 460 300 113			S	CAN	--	E2	D	L1	H	60
BMW 1 Series, 3/5 doors Hatchback F20/F21 inc. M-Sport-Package Please order separately thermal-insulation plate for socket holder,no. 7 277 733 at BMW dealers. 135i is not permitted to tow by manufacturer. For vehicles with petrol engines, please check whether it is necessary to replace the rear exhaust silencer.	09/11-03/14	KIT		303 317 900 113			22.0	8.8	75	1500		included in the KIT 303 460 300 113	-03/14		S	CAN	--	E2	D	L1	H	60
BMW 1 Series, 3/5 doors Hatchback F20/F21 exc. M models, exc. M-Sport-Package 135i is not permitted to tow by manufacturer. For vehicles with petrol engines, please check whether it is necessary to replace the rear exhaust silencer.	09/11-03/14	KIT		303 320 900 113			19.5	8.8	75	1500		included in the KIT 303 460 300 113	-03/14		S	CAN	--	E2	D	L1	H	60
BMW 1 Series, 3/5 doors Hatchback F20/F21 exc. M models, inc. M-Sport-Package Please order separately thermal-insulation plate for socket holder,no. 7 277 733 at BMW dealers. 135i is not permitted to tow by manufacturer. For vehicles with petrol engines, please check whether it is necessary to replace the rear exhaust silencer.	09/11-07/19			303 317 600 001		60	20.0	8.8	75	1500		303 460 300 113	-03/14		S	CAN	--	E2	D	L1	H	60
													303 481 300 113	03/14-07/19		S	CAN	--	E2	D	L1	H

BMW 1 Series, 3/5 doors Hatchback F20/F21 exc. M models, exc. M-Sport-Package 135i is not permitted to tow by manufacturer. For vehicles with petrol engines, please check whether it is necessary to replace the rear exhaust silencer.	09/11-07/19			303 320 600 001			60	17.5	8.8	75	1500		303 460 300 113	-03/14	S	CAN	--	E2	D	L1	H	60
													303 481 300 113	03/14-07/19	S	CAN	--	E2	D	L1	H	90
BMW 1 Series, 3/5 doors Hatchback F20/F21 exc. M models, inc. M-Sport-Package Please order separately thermal-insulation plate for socket holder, no. 7 277 733 at BMW dealers. 135i is not permitted to tow by manufacturer. For vehicles with petrol engines, please check whether it is necessary to replace the rear exhaust silencer.	03/14-07/19	KIT		303 001 900 113			60	20.5	8.8	75	1500		included in the KIT 303 481 300 113	03/14-07/19	S	CAN	--	E2	D	L1	H	90
BMW 1 Series, 3/5 doors Hatchback F20/F21 exc. M models, exc. M-Sport-Package 135i is not permitted to tow by manufacturer. For vehicles with petrol engines, please check whether it is necessary to replace the rear exhaust silencer.	03/14-07/19	KIT		303 002 900 113			60	19.2	8.8	75	1500		included in the KIT 303 481 300 113	03/14-07/19	S	CAN	--	E2	D	L1	H	90
BMW 1 Series, 5 doors Hatchback E87/E81 135i is not homologated for towing. With vehicles year of construction -07/05 the fixed towbar attachment bolts on the vehicle must be changed at a BMW garage.	09/04-09/11			303 323 600 001			60	20.0	8.0	90	1400		303 460 300 113		S	CAN	--	E2	D	L1	H	60
			KIT		303 323 900 113			60	22.0	8.0	90	1400		included in the KIT 303 460 300 113		S	CAN	--	E2	D	L1	H
BMW 1 Series, 5 doors Hatchback F40 inc. vehicles with M look exc. M135i xDrive Cooling system > 400 W may need to be retrofitted. exc. vehicles with tailgate that opens by sensor (foot sensor)	07/19-			303 497 600 001			60	20.0	8.6	100	1500		303 497 300 113	07/19-	S	CAN	--	E2	D	L1	V	90



















BMW



















BMW 1 Series, 5 doors Hatchback F40 inc. vehicles with M look exc. M135i xDrive Cooling system > 400 W may need to be retrofitted. exc. vehicles with tailgate that opens by sensor (foot sensor)	07/19-		303 498 600 001		60	22.7	8.6	100	1500		303 497 300 113	07/19-	S	CAN	--	E2	D	L1	V	90	
		KIT		303 497 900 113		60	21.5	8.6	100	1500		included in the KIT 303 497 300 113	07/19-	S	CAN	--	E2	D	L1	V	90
		KIT		303 498 900 113		60	24.2	8.6	100	1500		included in the KIT 303 497 300 113	07/19-	S	CAN	--	E2	D	L1	V	90
BMW 2 Series Active Tourer F45 exc. hybrid	09/14-10/21		303 355 600 001		90	17.5	10.4	80	2000		303 372 300 113	→	S	CAN	--	E	D	L1	V	105	
				303 372 600 001		90	21.0	10.4	80	2000		303 480 300 113	09/14-	S	CAN	--	E	D	L1	V	105
		KIT		303 373 900 113		90	19.5	10.4	80	2000		included in the KIT 303 480 300 113	09/14-	S	CAN	--	E	D	L1	V	105
		KIT		303 374 900 113		90	21.0	10.4	80	2000		included in the KIT 303 480 300 113	09/14-	S	CAN	--	E	D	L1	V	105
BMW 2 Series Active Tourer U06	11/21-		303 516 600 001		75	18.0	8.3	75	1400		303 516 300 113	11/21-	S	CAN	--	E2	D	L1	V	90	
				303 517 600 001		75	20.0	8.3	75	1400											
		KIT		303 516 900 113		75	21.0	8.3	75	1400		included in the KIT 303 516 300 113	11/21-	S	CAN	--	E2	D	L1	V	90
		KIT		303 517 900 113		75	22.2	8.3	75	1400		included in the KIT 303 516 300 113	11/21-	S	CAN	--	E2	D	L1	V	90

BMW 2 Series Convertible F23 exc. M models	02/15-07/21		303 320 600 001			60	17.5	8.8	75	1500		303 481 300 113	02/15-21	S	CAN	--	E2	D	L1	H	90	
				303 317 600 001			60	20.0	8.8	75	1500											
		KIT		303 002 900 113			60	19.2	8.8	75	1500		included in the KIT 303 481 300 113	02/15-21	S	CAN	--	E2	D	L1	H	90
		KIT		303 001 900 113			60	20.5	8.8	75	1500		included in the KIT 303 481 300 113	02/15-21	S	CAN	--	E2	D	L1	H	90
BMW 2 Series Coupé F22 exc. M models	03/14-07/21		303 320 600 001			60	17.5	8.8	75	1500		303 481 300 113	03/14-21	S	CAN	--	E2	D	L1	H	90	
				303 317 600 001			60	20.0	8.8	75	1500											
		KIT		303 002 900 113			60	19.2	8.8	75	1500		included in the KIT 303 481 300 113	03/14-21	S	CAN	--	E2	D	L1	H	90
		KIT		303 001 900 113			60	20.5	8.8	75	1500		included in the KIT 303 481 300 113	03/14-21	S	CAN	--	E2	D	L1	H	90
BMW 2 Series Gran Tourer F46	05/15-07/22		303 355 600 001		90	17.5	10.4	80	2000		303 372 300 113		-07/22	S	CAN	--	E	D	L1	V	105	
				303 372 600 001		90	21.0	10.4	80	2000		303 480 300 113		05/15--07/22	S	CAN	--	E	D	L1	V	105
		KIT		303 373 900 113		90	19.5	10.4	80	2000		included in the KIT 303 480 300 113		05/15--07/22	S	CAN	--	E	D	L1	V	105
		KIT		303 374 900 113		90	21.0	10.4	80	2000		included in the KIT 303 480 300 113		05/15--07/22	S	CAN	--	E	D	L1	V	105
BMW 3 Series Convertible E93 angular position of the towball, receptor tube is not in centre inc. models 335i and 335td and/or vehicles with turbocharger please order extra carriers for exhaust, order no. 303266600015	03/06-02/14		303 266 600 001			27.0	10.0	75	1800		303 460 300 113			S	CAN	--	E2	D	L1	H	60	

















BMW 3 Series Saloon F30 exc. M3, fits M Sport, exc. 330e BMW recommend fitting a heat shield for the detachable mechanism on petrol engines only - Order mounting bracket 303352613001 and heat shield separately from BMW dealers.	02/12-03/14	KIT		303 352 900 113		60	23.5	10.0	75	1800		included in the KIT 303 460 300 113	-03/14	S	CAN	--	E2	D	L1	H	60
BMW 3 Series Saloon F30 exc. M3, fits M Sport, exc. 330e	02/12-11/18			303 351 600 001		60	21.0	10.0	75	1800		303 460 300 113 303 481 300 113	-03/14 03/14-11/18	S S	CAN CAN	-- --	E2 E2	D D	L1 L1	H H	60 90
BMW 3 Series Saloon F30 exc. M3, fits M Sport, exc. 330e BMW recommend fitting a heat shield for the detachable mechanism on petrol engines only - Order mounting bracket 303352613001 and heat shield separately from BMW dealers.	02/12-11/18			303 352 600 001		60	21.5	10.0	75	1800		303 460 300 113 303 481 300 113	-03/14 03/14-11/18	S S	CAN CAN	-- --	E2 E2	D D	L1 L1	H H	60 90
BMW 3 Series Saloon F30 exc. M3, fits M Sport, exc. 330e	03/14-11/18	KIT		303 004 900 113		60	20.7	10.0	75	1800		included in the KIT 303 481 300 113	03/14-11/18	S	CAN	--	E2	D	L1	H	90
BMW 3 Series Saloon F30 exc. M3, fits M Sport, exc. 330e BMW recommend fitting a heat shield for the detachable mechanism on petrol engines only - Order mounting bracket 303352613001 and heat shield separately from BMW dealers.	03/14-11/18	KIT		303 005 900 113		60	23.2	10.0	75	1800		included in the KIT 303 481 300 113	03/14-11/18	S	CAN	--	E2	D	L1	H	90
BMW 3 Series Saloon G20 inc. M-Sport	11/18-			303 499 600 001		60	15.9	10.0	120	1800		303 504 300 113	11/18-	S	CAN	--	E2	D	L1	H	75
				303 500 600 001		60	18.2	10.0	120	1800											
		KIT		303 499 900 113		60	17.6	10.0	120	1800		included in the KIT 303 504 300 113	11/18-	S	CAN	--	E2	D	L1	H	75
		KIT		303 500 900 113		60	19.9	10.0	120	1800		included in the KIT 303 504 300 113	11/18-	S	CAN	--	E2	D	L1	H	75

























BMW

BMW 3 Series Touring E91 inc. M Sport, exc. M3. Angular position of the towball, receptor tube is not in centre For models 335i and 335td and/or vehicles with turbocharger please order extra carriers for exhaust, order no. 303240600015	09/05-08/12			303 330 600 001		75	26.5	10.0	75	1800		303 460 300 113	-03/14	S	CAN	--	E2	D	L1	H	60
		KIT		303 330 900 113		75	27.5	10.0	75	1800		included in the KIT 303 460 300 113	-03/14	S	CAN	--	E2	D	L1	H	60
BMW 3 Series Touring E91 inc. M Sport, exc. M3. Angular position of the towball exc. 335i and 335td and/or vehicles with turbocharger	09/05-08/12	KIT		303 331 900 113		75	21.0	9.2	75	1800		included in the KIT 303 460 300 113	-03/14	S	CAN	--	E2	D	L1	H	60
BMW 3 Series Touring E91 exc. M Sport, exc. M3 angular position of the towball exc. 335i and 335td and/or vehicles with turbocharger	09/05-08/12			303 428 600 001		75	17.4	9.2	75	1800		303 460 300 113	-03/14	S	CAN	--	E2	D	L1	H	60
BMW 3 Series Touring F31 exc. M3, fits M Sport, exc. 330e	09/12-03/14	KIT		303 351 900 113		60	23.0	10.0	75	1800		included in the KIT 303 460 300 113	-03/14	S	CAN	--	E2	D	L1	H	60
BMW 3 Series Touring F31 exc. M3, fits M Sport, exc. 330e BMW recommend fitting a heat shield for the detachable mechanism on petrol engines only - Order mounting bracket 303352613001 and heat shield separately from BMW dealers.	09/12-03/14	KIT		303 352 900 113		60	23.5	10.0	75	1800		included in the KIT 303 460 300 113	-03/14	S	CAN	--	E2	D	L1	H	60
BMW 3 Series Touring F31 exc. M3, fits M Sport, exc. 330e	09/12-06/19			303 351 600 001		60	21.0	10.0	75	1800		303 460 300 113	-03/14	S	CAN	--	E2	D	L1	H	60
				303 481 300 113									303 481 300 113	03/14-06/19	S	CAN	--	E2	D	L1	H
BMW 3 Series Touring F31 exc. M3, fits M Sport, exc. 330e BMW recommend fitting a heat shield for the detachable mechanism on petrol engines only - Order mounting bracket 303352613001 and heat shield separately from BMW dealers.	09/12-06/19			303 352 600 001		60	21.5	10.0	75	1800		303 460 300 113	-03/14	S	CAN	--	E2	D	L1	H	60
				303 481 300 113									303 481 300 113	03/14-06/19	S	CAN	--	E2	D	L1	H
BMW 3 Series Touring F31 exc. M3, fits M Sport, exc. 330e	03/14-06/19	KIT		303 004 900 113		60	20.7	10.0	75	1800		included in the KIT 303 481 300 113	03/14-06/19	S	CAN	--	E2	D	L1	H	90























BMW 3 Series Touring F31 exc. M3, fits M Sport, exc. 330e BMW recommend fitting a heat shield for the detachable mechanism on petrol engines only - Order mounting bracket 303352613001 and heat shield separately from BMW dealers.	03/14-06/19	KIT		303 005 900 113		60	23.2	10.0	75	1800				included in the KIT 303 481 300 113	03/14-06/19	S	CAN	--	E2	D	L1	H	90	
BMW 3 Series Touring G21 inc. M-Sport	07/19-			303 499 600 001		60	15.9	10.0	120	1800				303 504 300 113	07/19-	S	CAN	--	E2	D	L1	H	75	
				303 500 600 001		60	18.2	10.0	120	1800														
		KIT		303 499 900 113		60	17.6	10.0	120	1800					included in the KIT 303 504 300 113	07/19-	S	CAN	--	E2	D	L1	H	75
		KIT		303 500 900 113		60	19.9	10.0	120	1800					included in the KIT 303 504 300 113	07/19-	S	CAN	--	E2	D	L1	H	75
BMW 4 Series Convertible F33 exc. M models fits M Sport	03/14-11/20			303 351 600 001		60	21.0	10.0	75	1800				303 481 300 113	03/14-11/20	S	CAN	--	E2	D	L1	H	90	
BMW 4 Series Convertible F33 exc. M models fits M Sport BMW recommend fitting a heat shield for the detachable mechanism on petrol engines only - Order mounting bracket 303352613001 and heat shield separately from BMW dealers.	03/14-11/20			303 352 600 001		60	21.5	10.0	75	1800				303 481 300 113	03/14-11/20	S	CAN	--	E2	D	L1	H	90	
BMW 4 Series Convertible F33 fits M Sport	03/14-11/20	KIT		303 004 900 113		60	20.7	10.0	75	1800				included in the KIT 303 481 300 113	03/14-11/20	S	CAN	--	E2	D	L1	H	90	
BMW 4 Series Convertible F33 fits M Sport BMW recommend fitting a heat shield for the detachable mechanism on petrol engines only - Order mounting bracket 303352613001 and heat shield separately from BMW dealers.	03/14-11/20	KIT		303 005 900 113		60	23.2	10.0	75	1800				included in the KIT 303 481 300 113	03/14-11/20	S	CAN	--	E2	D	L1	H	90	

BMW

BMW 4 Series Convertible G23 exc. M4	12/20-			303 499 600 001		60	15.9	10.0	120	1800		303 504 300 113	12/20-	S	CAN	--	E2	D	L1	H	75
				303 500 600 001		60	18.2	10.0	120	1800											
BMW 4 Series Coupé F32 exc. M models fits M Sport	10/13-03/14	KIT		303 351 900 113		60	23.0	10.0	75	1800		included in the KIT 303 460 300 113	-03/14	S	CAN	--	E2	D	L1	H	60
BMW 4 Series Coupé F32 ekskl. M models fits M Sport BMW recommend fitting a heat shield for the detachable mechanism on petrol engines only - Order mounting bracket 303352613001 and heat shield separately from BMW dealers.	10/13-03/14	KIT		303 352 900 113		60	23.5	10.0	75	1800		included in the KIT 303 460 300 113	-03/14	S	CAN	--	E2	D	L1	H	60
BMW 4 Series Coupé F32 exc. M models fits M Sport	10/13-11/20			303 351 600 001		60	21.0	10.0	75	1800		303 460 300 113	-03/14	S	CAN	--	E2	D	L1	H	60
			303 481 300 113	03/14-11/20	S	CAN	--	E2	D	L1	H	90									
BMW 4 Series Coupé F32 exc. M models fits M Sport. BMW recommend fitting a heat shield for the detachable mechanism on petrol engines only - Order mounting bracket 303352613001 and heat shield separately from BMW dealers.	10/13-11/20			303 352 600 001		60	21.5	10.0	75	1800		303 460 300 113	-03/14	S	CAN	--	E2	D	L1	H	60
			303 481 300 113	03/14-11/20	S	CAN	--	E2	D	L1	H	90									
BMW 4 Series Coupé F32 fits M Sport	03/14-11/20	KIT		303 004 900 113		60	20.7	10.0	75	1800		included in the KIT 303 481 300 113	03/14-11/20	S	CAN	--	E2	D	L1	H	90
BMW 4 Series Coupé F32 fits M Sport BMW recommend fitting a heat shield for the detachable mechanism on petrol engines only - Order mounting bracket 303352613001 and heat shield separately from BMW dealers.	03/14-11/20	KIT		303 005 900 113		60	23.2	10.0	75	1800		included in the KIT 303 481 300 113	03/14-11/20	S	CAN	--	E2	D	L1	H	90











BMW 4 Series Coupé G22 exc. M4	12/20-		303 499 600 001		60	15.9	10.0	120	1800	303 504 300 113	11/20-	S	CAN	--	E2	D	L1	H	75		
			303 500 600 001		60	18.2	10.0	120	1800												
		KIT		303 499 900 113		60	17.6	10.0	120											1800	included in the KIT 303 504 300 113
		KIT		303 500 900 113		60	19.9	10.0	120											1800	included in the KIT 303 504 300 113
BMW 4 Series Gran Coupé F36 fits M Sport exc. M models	06/14-06/21		303 351 600 001		60	21.0	10.0	75	1800	303 481 300 113	06/14-06/21	S	CAN	--	E2	D	L1	H	90		
		KIT		303 004 900 113		60	20.7	10.0	75											1800	included in the KIT 303 481 300 113
BMW 4 Series Gran Coupé F36 fits M Sport exc. M models BMW recommend fitting a heat shield for the detachable mechanism on petrol engines only - Order mounting bracket 303352613001 and heat shield separately from BMW dealers.	06/14-06/21		303 352 600 001		60	21.5	10.0	75	1800	303 481 300 113	06/14-06/21	S	CAN	--	E2	D	L1	H	90		
		KIT		303 005 900 113		60	23.2	10.0	75											1800	included in the KIT 303 481 300 113
BMW 4 Series Gran Coupé G26	07/21-		303 514 600 001		75	17.1	12.3	145	2250	303 504 300 113	07/21-	S	CAN	--	E2	D	L1	H	75		
		KIT		303 514 900 113		75	18.8	12.3	145											2250	included in the KIT 303 504 300 113
BMW 5 Series Saloon E60 exc. M5, only for vehicles with sport equipment Please order separately cover for bumper cutout 5112 7120 005 at BMW dealer's.	07/03-02/10		303 235 600 001		150	20.0	11.4	90	2200	303 460 300 113	-07/13	S	CAN	--	E2	D	L1	H	60		
		KIT		303 235 900 113		150	22.0	11.4	90											2200	included in the KIT 303 460 300 113



























BMW

BMW 5 Series Saloon E60 exc. M5, exc. vehicles with sport equipment	07/03-02/10			303 294 600 001			100	20.0	11.4	90	2200		303 460 300 113	-07/13	S	CAN	--	E2	D	L1	H	60
		KIT		303 294 900 113			100	22.0	11.4	90	2200		included in the KIT 303 460 300 113	-07/13	S	CAN	--	E2	D	L1	H	60
BMW 5 Series Saloon F10 exc. M5 fits M-Sport	03/10-07/13	KIT		303 337 900 113		45	25.0	11.8	100	2200		included in the KIT 303 460 300 113	-07/13	S	CAN	--	E2	D	L1	H	60	
		KIT		303 338 900 113		45	30.0	11.8	100	2200		included in the KIT 303 460 300 113	-07/13	S	CAN	--	E2	D	L1	H	60	
BMW 5 Series Saloon F10 exc. M5 fits M-Sport	03/10-01/17			303 397 600 001		45	23.0	11.8	100	2200		303 460 300 113	-07/13	S	CAN	--	E2	D	L1	H	60	
				303 398 600 001		45	28.0	11.8	100	2200		303 481 300 113	07/13-01/17	S	CAN	--	E2	D	L1	H	90	
BMW 5 Series Saloon F10 exc. M5 fits M-Sport	07/13-01/17	KIT		303 007 900 113		45	24.7	11.8	100	2200		included in the KIT 303 481 300 113	07/13-01/17	S	CAN	--	E2	D	L1	H	90	
		KIT		303 008 900 113		45	20.2	11.8	100	2200		included in the KIT 303 481 300 113	07/13-01/17	S	CAN	--	E2	D	L1	H	90	
BMW 5 Series Saloon G30	02/17-10/23			303 413 600 001		60	20.5	11.9	90	2000		303 504 300 113	02/17-10/23	S	CAN	--	E2	D	L1	H	75	
				303 412 600 001		60	21.9	11.9	90	2000												
		KIT		303 012 900 113		60	21.8	11.9	90	2000		included in the KIT 303 504 300 113	02/17-10/23	S	CAN	--	E2	D	L1	H	75	
		KIT		303 013 900 113		60	24.1	11.9	90	2000		included in the KIT 303 504 300 113	02/17-10/23	S	CAN	--	E2	D	L1	H	75	
BMW 5 Series Touring E61 exc. M5, only for vehicles with sport equipment Please order separately cover for bumper cutout 5112 7126 377 at BMW dealer's.	07/04-09/10			303 235 600 001		150	20.0	11.4	90	2200		303 460 300 113	-07/13	S	CAN	--	E2	D	L1	H	60	
		KIT		303 235 900 113		150	22.0	11.4	90	2200		included in the KIT 303 460 300 113	-07/13	S	CAN	--	E2	D	L1	H	60	

























BMW 5 Series Touring E61 exc. M5, exc. vehicles with sport equipment	07/04-09/10			303 294 600 001			100	20.0	11.4	90	2200		303 460 300 113		-07/13	S	CAN	--	E2	D	L1	H	60
		KIT		303 294 900 113			100	22.0	11.4	90	2200		included in the KIT 303 460 300 113		-07/13	S	CAN	--	E2	D	L1	H	60
BMW 5 Series Touring F11 fits M-Sport	09/10-07/13	KIT		303 337 900 113		45	25.0	11.8	100	2200		included in the KIT 303 460 300 113		-07/13	S	CAN	--	E2	D	L1	H	60	
		KIT		303 338 900 113		45	30.0	11.8	100	2200		included in the KIT 303 460 300 113		-07/13	S	CAN	--	E2	D	L1	H	60	
BMW 5 Series Touring F11 fits M-Sport	09/10-01/17			303 397 600 001		45	23.0	11.8	100	2200		303 460 300 113		-07/13	S	CAN	--	E2	D	L1	H	60	
				303 398 600 001		45	28.0	11.8	100	2200		303 481 300 113		07/13-01/17	S	CAN	--	E2	D	L1	H	90	
BMW 5 Series Touring F11 fits M-Sport	07/13-01/17	KIT		303 008 900 113		45	20.2	11.8	100	2200		included in the KIT 303 481 300 113		07/13-01/17	S	CAN	--	E2	D	L1	H	90	
BMW 5 Series Touring G31	02/17-10/23			303 413 600 001		60	20.5	11.9	90	2000		303 504 300 113		02/17-10/23	S	CAN	--	E2	D	L1	H	75	
				303 412 600 001		60	21.9	11.9	90	2000													
		KIT		303 012 900 113		60	21.8	11.9	90	2000		included in the KIT 303 504 300 113		02/17-10/23	S	CAN	--	E2	D	L1	H	75	
		KIT		303 013 900 113		60	24.1	11.9	90	2000		included in the KIT 303 504 300 113		02/17-10/23	S	CAN	--	E2	D	L1	H	75	
BMW 6 Series is not permitted to tow by the vehicle manufacturer.																							















BMW

BMW 6 Series Gran Turismo G32	06/17-10/23			303 413 600 001			60	20.5	11.9	90	2000		303 504 300 113	06/17-10/23	S	CAN	--	E2	D	L1	H	75
				303 412 600 001			60	21.9	11.9	90	2000											
	KIT			303 012 900 113			60	21.8	11.9	90	2000		included in the KIT 303 504 300 113	06/17-10/23	S	CAN	--	E2	D	L1	H	75
		KIT			303 013 900 113			60	24.1	11.9	90	2000		included in the KIT 303 504 300 113	06/17-10/23	S	CAN	--	E2	D	L1	H
BMW 7 Series Saloon G11/12 inc. facelift 2019- exc. M models, exc. 745e	07/15-05/22			303 413 600 001			60	20.5	11.9	90	2000											
				303 412 600 001			60	21.9	11.9	90	2000											
BMW M5 Towbar is only available at the BMW dealer's.																						
BMW X1 E84 exc. vehicles fitted with the BMW factory fitted bike rack inc. M-Sport-package / X-drive	10/09-10/15	KIT		303 313 900 113			90	19.0	10.3	80	2000		included in the KIT 303 460 300 113		S	CAN	--	E2	D	L1	H	60
		KIT			303 314 900 113			90	20.0	10.3	80	2000		included in the KIT 303 460 300 113		S	CAN	--	E2	D	L1	H
BMW X1 E84 exc. vehicles fitted with the BMW factory fitted bike rack inc. M-Sport-package / X-drive	10/09-10/15			303 393 600 001			90	17.0	10.3	80	2000		303 460 300 113		S	CAN	--	E2	D	L1	H	60
				303 394 600 001			90	18.0	10.3	80	2000											







BMW X1 F48 fits M-Sport For vehicles with a tailgate sensor, the sensor cable must be adapted.	10/15-10/22			303 355 600 001		90	17.5	10.4	80	2000		303 372 300 113			S	CAN	--	E	D	L1	V	105
				303 372 600 001		90	21.0	10.4	80	2000		303 480 300 113		10/15-	S	CAN	--	E	D	L1	V	105
		KIT		303 373 900 113		90	19.5	10.4	80	2000		included in the KIT 303 480 300 113		10/15-	S	CAN	--	E	D	L1	V	105
		KIT		303 374 900 113		90	21.0	10.4	80	2000		included in the KIT 303 480 300 113		10/15-	S	CAN	--	E	D	L1	V	105
BMW X2 F39 exc. M35i only for vehicles with a single tailpipe on the right and left	11/17-			303 475 600 001		75	29.0	12.0	130	2500		303 372 300 113			S	CAN	--	E	D	L1	V	105
				303 476 600 001		75	29.0	12.0	130	2500		303 480 300 113		11/17-	S	CAN	--	E	D	L1	V	105
		KIT		303 480 900 113		75	31.0	12.0	130	2500		included in the KIT 303 480 300 113		11/17-	S	CAN	--	E	D	L1	V	105
BMW X3 Depending upon equipment partial cutout + cover is necessary. Please order separately with the BMW dealer.	01/04-11/10			303 304 600 001			21.0	12.6	100	2200		303 189 300 113			S	FRE	--	E	D	L1	V	120
		KIT		303 304 900 113			23.0	12.6	100	2200		included in the KIT 303 189 300 113			S	FRE	--	E	D	L1	V	120
BMW X3	01/04-11/10			303 327 600 001			16.0	10.9	85	2000		303 189 300 113			S	FRE	--	E	D	L1	V	120
		KIT		303 327 900 113			18.0	10.9	85	2000		included in the KIT 303 189 300 113			S	FRE	--	E	D	L1	V	120
BMW X3 F25 inc. M-Sport	11/10-09/14	KIT		303 339 900 113		60	18.5	12.5	100	2400		included in the KIT 303 460 300 113		-09/14	S	CAN	--	E2	D	L1	H	60
		KIT		303 340 900 113		60	19.5	12.5	100	2400		included in the KIT 303 460 300 113		-09/14	S	CAN	--	E2	D	L1	H	60











BMW



















BMW X3 F25 inc. M-Sport	11/10-06/17			303 339 600 001		60	16.0	12.0	100	2400		303 460 300 113	-09/14	S	CAN	--	E2	D	L1	H	60
				303 404 600 001		60	16.8	12.6	100	2400		303 481 300 113	10/14 -06/17	S	CAN	--	E2	D	L1	H	90
BMW X3 F25 inc. M-Sport	10/14-06/17	KIT		303 009 900 113		60	16.7	12.0	100	2400		included in the KIT 303 481 300 113	10/14 -06/17	S	CAN	--	E2	D	L1	H	90
		KIT		303 010 900 113		60	17.5	12.6	100	2400		included in the KIT 303 481 300 113	10/14 -06/17	S	CAN	--	E2	D	L1	H	90
BMW X3 G01 inc. M-Sport inc. facelift exc. iX3	07/17-			303 495 600 001		60	18.0	12.5	100	2400		303 504 300 113	07/17-	S	CAN	--	E2	D	L1	H	75
				303 496 600 001		60	20.0	12.5	100	2400											
		KIT		303 014 900 113		60	20.2	12.5	100	2400		included in the KIT 303 504 300 113	07/17-	S	CAN	--	E2	D	L1	H	75
		KIT		303 015 900 113		60	23.7	12.5	100	2400		included in the KIT 303 504 300 113	07/17-	S	CAN	--	E2	D	L1	H	75
BMW X4 F26 inc. M-Sport	06/14-04/18			303 404 600 001		60	16.8	12.6	100	2400		303 481 300 113	06/14 -04/18	S	CAN	--	E2	D	L1	H	90
		KIT		303 010 900 113		60	17.5	12.6	100	2400		included in the KIT 303 481 300 113	06/14 -04/18	S	CAN	--	E2	D	L1	H	90
BMW X4 G02 inc. M-Sport inc. facelift 21-	05/18-			303 483 600 001		75	19.0	12.5	100	2400		303 504 300 113	05/18-	S	CAN	--	E2	D	L1	H	75
		KIT		303 016 900 113		75	21.8	12.5	100	2400		included in the KIT 303 504 300 113	05/18-	S	CAN	--	E2	D	L1	H	75
BMW X5 E53 inc. M-Sport No towbar can be mounted on vehicles with US-specification.	06/00-12/06			303 207 600 001			34.0	15.5	150	3500		303 137 300 113	for prepared vehicles	S	FRE	--	E	D	--	H	30























BMW X5 E53 with preliminary setup incl. M-Sport No towbar can be mounted on vehicles with US-specification.	06/00-12/06	KIT		303 207 900 113			36.0	15.5	150	3500			included in the KIT 303 137 300 113		for prepared vehicles	S	FRE	--	E	D	--	H	30		
BMW X5 E70 fits X5 M Sport package	01/07-10/13			303 368 600 001			90	26.5	16.0	150	3500		303 368 300 113	→	11/13-07/18 exc. X5M motors	S	CAN	--	E2	D	L1	H	45		
													303 451 300 113		-11/13 exc. X5M motors	S	CAN	--	E	D	L1	H	45		
													303 481 300 113		11/13-07/18 exc. X5M motors	S	CAN	--	E2	D	L1	H	90		
BMW X5 E70 inc. X5 M-Sport package	01/07-11/13	KIT		303 273 900 113			60	31.0	15.5	150	3500		included in the KIT 303 451 300 113		-11/13 exc. X5M motors	S	CAN	--	E	D	L1	H	45		
BMW X5 F15 inc. M-Sport	11/13-07/18	KIT		303 368 900 113	→		90	28.5	16.0	150	3500		included in the KIT 303 368 300 113	→	11/13-07/18 exc. X5M motors	S	CAN	--	E2	D	L1	H	45		
													303 011 900 113			90	25.2	16.0	150	3500		included in the KIT 303 481 300 113		11/13-07/18 exc. X5M motors	S
BMW X5 F15 inc. M-Sport package	11/13-07/18			303 368 600 001			90	26.5	16.0	150	3500		303 368 300 113	→	11/13-07/18 exc. X5M motors	S	CAN	--	E2	D	L1	H	45		
BMW X5 G05 inc. M-Sport	08/18-			303 485 600 001			60	23.6	16.3	140	3500														
																		included in the KIT 303 504 300 113		08/18-	S	CAN	--	E2	D
BMW X6 inc. X6M. Hybrid models are not permitted to tow by the vehicle manufacturer. Please order separately cover for bumper cutout at BMW dealers.	05/08-12/14			303 290 600 001				31.5	16.0	140	3500		303 451 300 113		exc. X6M motors	S	CAN	--	E	D	L1	H	45		
																		included in the KIT 303 451 300 113		exc. X6M motors	S	CAN	--	E	D

BMW























BMW X6 F16	12/14-19			303 368 600 001		90	26.5	16.0	150	3500		303 368 300 113	→	-19 exc. X6M motors	S	CAN	--	E2	D	L1	H	45	
												303 481 300 113		12/14-19 exc. X5M motors	S	CAN	--	E2	D	L1	H	90	
		KIT		303 368 900 113	→		90	28.5	16.0	150	3500		included in the KIT 303 368 300 113	→	-19 exc. X6M motors	S	CAN	--	E2	D	L1	H	45
		KIT		303 011 900 113			90	25.2	16.0	150	3500		included in the KIT 303 481 300 113		12/14-19 exc. X5M motors	S	CAN	--	E2	D	L1	H	90
BMW X6 G06 inc. M-Sport	08/19-			303 485 600 001		60	23.6	16.3	140	3500													
		KIT		303 485 900 113			60	25.4	16.3	140	3500		included in the KIT 303 504 300 113		08/19-	S	CAN	--	E2	D	L1	H	75
BMW i4 G26	11/21-			303 514 600 001		75	17.1	12.3	145	2250		303 504 300 113		11/21-	S	CAN	--	E2	D	L1	H	75	
		KIT		303 514 900 113			75	18.8	12.3	145	2250		included in the KIT 303 504 300 113		11/21-	S	CAN	--	E2	D	L1	H	75
BMW iX3 G08	09/20-			303 513 600 001		60	15.9	5.8	75	750		303 504 300 113		09/20-	S	CAN	--	E2	D	L1	H	75	
		KIT		303 513 900 113			60	17.6	5.8	75	750		included in the KIT 303 504 300 113		09/20-	S	CAN	--	E2	D	L1	H	75





















Chevrolet Captiva (S3X)	06/06-09/18		342 217 600 001		90	21.5	12.3	150	2500	342 027 300 113	→	for vehicles with preparation	S	FRE	--	E1	D	L1	H	30	
Chevrolet Trax	03/13-06/19		314 511 600 001		60	21.5	8.6	75	1400	314 386 300 113			S	CAN	--	E	D	L1	V	90	
			314 510 600 001		60	21.0	8.6	75	1400				S	CAN	--	E	D	L1	V	90	
		KIT		314 511 900 113		60	25.0	8.6	75	1400	included in the KIT 314 386 300 113			S	CAN	--	E	D	L1	V	90
		KIT		314 497 900 113		60	23.0	7.5	75	1200	included in the KIT 314 386 300 113			S	CAN	--	E	D	L1	V	90

Citraën Berlingo Van, minibus Multispace	11/96-04/08			304 054 600 001		90	14.8	7.8	70	1350		304 054 300 113			S	FRE	--	E1	D1	--	V	75
		KIT		304 054 900 113		90	16.8	7.8	70	1350		included in the KIT 304 054 300 113			S	FRE	--	E1	D1	--	V	75
Citraën Berlingo First	04/08-12/11			304 054 600 001		90	14.8	7.8	70	1350		304 054 300 113			S	FRE	--	E1	D1	--	V	75
		KIT		304 054 900 113		90	16.8	7.8	70	1350		included in the KIT 304 054 300 113			S	FRE	--	E1	D1	--	V	75
Citraën Berlingo L1 short wheelbase, vehicle length = 4380 mm fits Multispace, inc. Berlingo E- Car	04/08-11/11	KIT		304 091 900 113		90	17.0	8.7	64	1600		included in the KIT 304 400 300 113	-11/11 -> OPR12775	S	CAN	C1	E	D	L1	H	105	
		KIT		304 092 900 113		90	21.0	8.7	64	1600		included in the KIT 304 400 300 113	-11/11 -> OPR12775	S	CAN	C1	E	D	L1	H	105	
Citraën Berlingo L1 short wheelbase, vehicle length = 4380 mm fits Multispace, inc. Berlingo E- Car	04/08-08/18			304 091 600 001		90	15.0	8.7	64	1600		304 400 300 113	-11/11 -> OPR12775	S	CAN	C1	E	D	L1	H	105	
				304 092 600 001		90	19.0	8.7	64	1600		304 402 300 107	11/11- OPR12776->	S	CAN	C1	E	--	--	V	105	
				304 402 300 113								304 402 300 113	11/11- OPR12776->	S	CAN	C1	E	D	L1	V	105	
Citraën Berlingo L1 inc. Berlingo Van inc. towball	09/18-			304 118 600 001		90	17.0	8.4	64	1600		314 594 300 113	inc. WLC 2.0	S	A	C	E	D	L	V	90	
Citraën Berlingo L1 inc. Berlingo Van	09/18-			304 207 600 001		60	20.0	8.6	75	1500												
				304 209 600 001		60	20.5	8.6	75	1500		314 594 300 113	inc. WLC 2.0	S	A	C	E	D	L	V	90	
		KIT		304 207 900 113		60	21.2	8.6	75	1500		included in the KIT 314 594 300 113	inc. WLC 2.0	S	A	C	E	D	L	V	90	
		KIT		304 209 900 113		60	21.8	8.6	75	1500		included in the KIT 314 594 300 113	inc. WLC 2.0	S	A	C	E	D	L	V	90	
Citraën Berlingo L2 long wheelbase, vehicle length = 4628 mm	04/08-11/11	KIT		304 129 900 113		90	18.3	8.7	64	1600		included in the KIT 304 400 300 113	-11/11 -> OPR12775	S	CAN	C1	E	D	L1	H	105	





























Citroën C3 Aircross II 120HP turbo S&S EAT6 (DV5RC / AT6): Please check if there is a towing capacity in the vehicle's documents	06/17-	KIT		304 203 900 113		60	21.0	6.4	78	1000		included in the KIT 304 203 300 113	06/17- inc. WLC 2.0	S	A	C	E2	D1	L1	V	60
		KIT		304 204 900 113		60	23.2	6.4	78	1000		included in the KIT 304 203 300 113	06/17- inc. WLC 2.0	S	A	C	E2	D1	L1	V	60
Citroën C3 Picasso	03/09-07/17			304 127 600 001		60	15.2	7.3	61	1200		304 402 300 107 304 402 300 113		S	CAN	C1	E	--	--	V	105
		KIT		304 127 900 113		60	17.2	7.3	61	1200		included in the KIT 304 402 300 113		S	CAN	C1	E	D	L1	V	105
Citroën C4 Aircross	03/12-04/17			340 092 600 001		90	22.0	8.5	70	1400		340 093 300 113		S	A	--	--	D	L	H	60
				340 093 600 001		90	24.0	8.5	70	1400				S	A	--	--	D	L	H	60
		KIT		340 092 900 113		90	24.0	8.5	70	1400		included in the KIT 340 093 300 113		S	A	--	--	D	L	H	60
		KIT		340 093 900 113		90	26.0	8.5	70	1400		included in the KIT 340 093 300 113		S	A	--	--	D	L	H	60
Citroën C4 Cactus exc. AdBlue	09/14-09/20			304 159 600 001			17.0	5.2	55	780		304 203 300 113 315 185 300 113	04/18-09/20 inc. WLC 2.0	S	A	C	E2	D1	L1	V	60
													-03/18	S	CAN	C	E	D	L1	V	60
Citroën C4 Grand Picasso	11/06-01/11	KIT		304 099 900 113		60	24.0	9.7	75	1700		included in the KIT 304 401 300 113	-01/11 ->OPR12531	S	CAN	C1	E	D	L1	V	105
		KIT		304 100 900 113		60	24.7	9.7	80	1700		included in the KIT 304 401 300 113	-01/11 ->OPR12531	S	CAN	C1	E	D	L1	V	105
Citroën C4 Grand Picasso	11/06-09/13			315 177 600 001		120	21.0	10.0	75	1550		304 401 300 113	-01/11 ->OPR12531	S	CAN	C1	E	D	L1	V	105
				315 178 600 001		90	22.5	9.7	80	1700		315 109 300 113	01/11- OPR12530->	S	CAN	C	E	D	L1	V	105











Citroën

Citroën C4 Grand Picasso / Grand Space Tourer inc. AdBlue	10/13-06/22			304 151 600 001		90	21.0	9.5	75	1750		315 196 300 113	-06/22	S	CAN	C	E2	D	L1	V	75
				304 152 600 001		90	24.0	9.5	75	1750											
		KIT		304 151 900 113		90	21.0	9.5	75	1750		included in the KIT 315 196 300 113	-06/22	S	CAN	C	E2	D	L1	V	75
		KIT		304 152 900 113		90	24.0	9.5	75	1750		included in the KIT 315 196 300 113	-06/22	S	CAN	C	E2	D	L1	V	75
Citroën C4 III exc. ë-C4	10/20-			304 213 600 001		90	23.7	8.5	103	1400		304 203 300 113	10/20- exc. ë-C4	S	A	C	E2	D1	L1	V	60
		KIT		304 202 900 113		90	25.4	8.5	103	1400		included in the KIT 304 203 300 113	10/20- exc. ë-C4	S	A	C	E2	D1	L1	V	60
Citroën C4 Saloon	11/10-05/18			304 148 600 001		60	19.0	9.2	75	1550		304 144 300 113		S	CAN	C	E	D	L	V	90
		KIT		304 148 900 113		60	21.0	9.2	75	1550		included in the KIT 304 144 300 113		S	CAN	C	E	D	L	V	90
Citroën C4 Picasso	11/06-01/11	KIT		304 099 900 113		60	24.0	9.7	75	1700		included in the KIT 304 401 300 113	-01/11 ->OPR12531	S	CAN	C1	E	D	L1	V	105
		KIT		304 100 900 113		60	24.7	9.7	80	1700		included in the KIT 304 401 300 113	-01/11 ->OPR12531	S	CAN	C1	E	D	L1	V	105
Citroën C4 Picasso	11/06-05/13			315 177 600 001		120	21.0	10.0	75	1550		304 401 300 113	-01/11 ->OPR12531	S	CAN	C1	E	D	L1	V	105
				315 178 600 001		90	22.5	9.7	80	1700		315 109 300 113	01/11- OPR12530->	S	CAN	C	E	D	L1	V	105





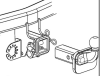





Citroën C4 Picasso / Space Tourer inc. AdBlue	06/13-10/20			304 151 600 001		90	21.0	9.5	75	1750	315 196 300 113			S	CAN	C	E2	D	L1	V	75
				304 152 600 001		90	24.0	9.5	75	1750											
		KIT		304 151 900 113		90	21.0	9.5	75	1750	included in the KIT 315 196 300 113			S	CAN	C	E2	D	L1	V	75
		KIT		304 152 900 113		90	24.0	9.5	75	1750	included in the KIT 315 196 300 113			S	CAN	C	E2	D	L1	V	75
Citroën C4 X Please check if there is a towing capacity in the car documents.	09/22-			304 216 600 001		90	25.0	7.1	61	1200	304 203 300 113	09/22-	S	A	C	E2	D1	L1	V	60	
Citroën C4 X Please check if there is a towing capacity in the car documents.	09/22-	KIT		304 216 900 113		90	26.6	7.1	61	1200	included in the KIT 304 203 300 113	09/22-	S	A	C	E2	D1	L1	V	60	
Citroën C5 Aircross exc. Hybrid	11/18-			315 243 600 001		120	22.0	10.0	80	2000	304 204 300 113	11/18-	S	CAN	C	E	D1	L1	V	75	
				315 244 600 001		120	24.0	10.0	80	2000											
		KIT		304 213 900 113		120	23.5	10.0	80	2000	included in the KIT 304 204 300 113	11/18-	S	CAN	C	E	D1	L1	V	75	
		KIT		304 214 900 113		120	26.7	10.0	80	2000	included in the KIT 304 204 300 113	11/18-	S	CAN	C	E	D1	L1	V	75	
Citroën C5 Aircross Hybrid only Plugin-Hybrid	04/20-			314 599 600 001		90	26.7	8.1	95	1270											















Citroën

Citroën C5 Estate	05/08-05/17		304 133 600 001		90	23.0	10.4	75	1900	304 400 300 113	S	CAN	C1	E	D	L1	H	105
			304 135 600 001		90	25.4	10.4	75	1900									
	KIT		304 146 900 113		120	29.0	10.4	80	1900	included in the KIT 304 400 300 113	S	CAN	C1	E	D	L1	H	105
	KIT		304 145 900 113		120	31.4	10.4	80	1900	included in the KIT 304 400 300 113	S	CAN	C1	E	D	L1	H	105
Citroën C5 Saloon	05/08-05/17		304 133 600 001		90	23.0	10.4	75	1900	304 400 300 113	S	CAN	C1	E	D	L1	H	105
			304 135 600 001		90	25.4	10.4	75	1900									
	KIT		304 146 900 113		120	29.0	10.4	80	1900	included in the KIT 304 400 300 113	S	CAN	C1	E	D	L1	H	105
	KIT		304 145 900 113		120	31.4	10.4	80	1900	included in the KIT 304 400 300 113	S	CAN	C1	E	D	L1	H	105
Citroën C5X ND_NC_ inc. Plugin-Hybrid	09/21-		314 604 600 001		90	20.0	9.2	108	1650	314 602 300 113	S	CAN	C	E	D	L1	H	75
			314 605 600 001		90	22.0	9.2	112	1650									
	KIT		314 604 900 113		90	22.0	9.2	108	1650	included in the KIT 314 602 300 113	S	CAN	C	E	D	L1	H	75
	KIT		314 605 900 113		90	24.0	9.2	108	1650	included in the KIT 314 602 300 113	S	CAN	C	E	D	L1	H	75
Citroën DS4	04/11-10/15		304 148 600 001		60	19.0	9.2	75	1550	304 144 300 113	S	CAN	C	E	D	L	V	90
		KIT		304 148 900 113		60	21.0	9.2	75	1550	included in the KIT 304 144 300 113	S	CAN	C	E	D	L	V









Citroën DS5 exc. hybrid	02/12-07/15			304 149 600 001			120	29.0	8.5	75	1500		304 144 300 113			S	CAN	C	E	D	L	V	90
Citroën Van inc. towball	02/95-06/06			306 329 600 001	→		60	29.0	12.5	130	2000												
Citroën Van For vehicles with long superstructure L4/XL please order separately a set distance tubes to strengthen the framework, no. 906270650003. Some vehicles 03/08- do not have chassis bores. In this case it is necessary to bore them subsequent. For the mounting time will last 120 min. longer.	06/06-			306 491 600 001			120	32.0	16.9	150	3000		306 510 300 113	-02/11 chassis no. 1948840	S	FRE	--	E	D1	L1	V	105	
													306 553 300 113	02/11- from chassis no. 1948841	S	FRE	--	E	D1	L1	V	105	
Citroën Van inc. towball For vehicles with long superstructure L4/XL please order separately a set distance tubes to strengthen the framework, no. 906270650003. Some vehicles 03/08- do not have chassis bores. In this case it is necessary to bore them subsequent. For the mounting time will last 120 min. longer.	06/06-			306 490 600 001			120	32.0	16.9	150	3000		306 510 300 113	-02/11 chassis no. 1948840	S	FRE	--	E	D1	L1	V	105	
													306 553 300 113	02/11- from chassis no. 1948841	S	FRE	--	E	D1	L1	V	105	
Citroën Van inc. towball Some vehicles 03/08- do not have chassis bores. In this case it is necessary to bore them subsequent. For the mounting time will last 120 min. longer.	06/06-			306 357 600 001	→		60	29.0	15.8	150	3000		306 510 300 113	-02/11 chassis no. 1948840	S	FRE	--	E	D1	L1	V	105	
													306 553 300 113	02/11- from chassis no. 1948841	S	FRE	--	E	D1	L1	V	105	
Citroën Van inc. towball for vehicles up to 6 m long 51 mm square holder	06/06-			306 563 600 001			60	25.7	15.1	100	2500		306 510 300 113	-02/11 chassis no. 1948840	S	FRE	--	E	D1	L1	V	105	
													306 553 300 113	02/11- from chassis no. 1948841	S	FRE	--	E	D1	L1	V	105	
Citroën Van For vehicles with long superstructure L4/XL please order separately a set distance tubes to strengthen the framework, no. 906270650003. Some vehicles 03/08- do not have chassis bores. In this case it is necessary to bore them subsequent. For the mounting time will last 120 min. longer.	06/06-02/11	KIT		306 271 900 113			120	34.0	16.9	150	3000		included in the KIT 306 510 300 113	-02/11 chassis no. 1948840	S	FRE	--	E	D1	L1	V	105	



















Citroën

<p>Citroën Van inc. towball For vehicles with long superstructure L4/XL please order separately a set distance tubes to strengthen the framework, no. 906270650003. Some vehicles 03/08- do not have chassis bores. In this case it is necessary to bore them subsequent. For the mounting time will last 120 min. longer.</p>	06/06-02/11	KIT		306 330 900 113			120	34.0	16.9	150	3000		included in the KIT 306 510 300 113		-02/11 chassis no. 1948840	S	FRE	--	E	D1	L1	V	105
<p>Citroën Van For vehicles with long superstructure L4/XL please order separately a set distance tubes to strengthen the framework, no. 906270650003. Some vehicles 03/08- do not have chassis bores. In this case it is necessary to bore them subsequent. For the mounting time will last 120 min. longer.</p>	02/11-	KIT		306 491 900 113			120	32.8	16.9	150	3000		included in the KIT 306 553 300 113		02/11- from chassis no. 1948841	S	FRE	--	E	D1	L1	V	105
<p>Citroën Van inc. towball For vehicles with long superstructure L4/XL please order separately a set distance tubes to strengthen the framework, no. 906270650003. Some vehicles 03/08- do not have chassis bores. In this case it is necessary to bore them subsequent. For the mounting time will last 120 min. longer.</p>	02/11-	KIT		306 490 900 113			120	32.2	16.9	150	3000		included in the KIT 306 553 300 113		02/11- from chassis no. 1948841	S	FRE	--	E	D1	L1	V	105
<p>Citroën Van inc. towball Some vehicles 03/08- do not have chassis bores. In this case it is necessary to bore them subsequent. For the mounting time will last 120 min. longer.</p>	02/11-	KIT		306 553 900 113	→		>150	31.0	15.8	150	3000		included in the KIT 306 553 300 113		02/11- from chassis no. 1948841	S	FRE	--	E	D1	L1	V	105
<p>Citroën Relay Chassis Cab inc. towball</p>	02/95-06/06			306 329 600 001	→		60	29.0	12.5	130	2000		300 052 300 113 300 060 300 113		03/02- -03/02	--	FRE	--	E1	D1	--	V	
<p>Citroën Relay Chassis Cab inc. towball For vehicles with long superstructure L4/XL please order separately a set distance tubes to strengthen the framework, no. 906270650003.</p>	06/06-			306 492 600 001			120	35.0	15.9	150	3000		306 531 300 113			S	FRE	--	E1	D	--	V	90











Citroën Relay Chassis Cab inc. towball For vehicles with long superstructure L4/XL please order separately a set distance tubes to strengthen the framework, no. 90627065003.	06/06-	KIT		306 318 900 113		120	37.0	15.9	150	3000				included in the KIT 306 531 300 113		S	FRE	--	E1	D	--	V	90
Citroën Relay Chassis Cab inc. towball	06/06-			306 357 600 001	→	60	29.0	15.8	150	3000			306 531 300 113		S	FRE	--	E1	D	--	V	90	
Citroën Relay Motor homes no towbar offered	06/06-												306 553 300 183		S	FRE	--	E1	D	L1	V		
Citroën Dispatch	01/07-06/16			306 331 600 001		75	22.5	12.2	122	2200			304 400 300 113	-06/16	S	CAN	C1	E	D	L1	H	105	
				306 333 600 001		75	22.5	12.2	122	2200													
		KIT		306 331 900 113		75	22.5	12.2	122	2200			included in the KIT 304 400 300 113	-06/16	S	CAN	C1	E	D	L1	H	105	
		KIT		306 333 900 113		75	24.5	12.2	122	2200			included in the KIT 304 400 300 113	-06/16	S	CAN	C1	E	D	L1	H	105	
Citroën Dospatch / SpaceTourer inc. E-Jumpy / E-Spacetourer inc. towball	07/16-			304 190 600 001		45	26.0	13.9	104	2500			304 157 300 113	-10/19	S	CAN	C	E	D	L1	H	90	
													314 585 300 113	11/19- inc. WLC 2.0 with preliminary setup inc. E- Jumpy / E- Spacetourer	S	FRE	C	E	D	L1	H	75	
Citroën Dospatch / SpaceTourer inc. E-Jumpy / E-Spacetourer	07/16-			335 106 600 001		60	25.5	13.9	104	2500			304 157 300 113	-10/19	S	CAN	C	E	D	L1	H	90	
													314 585 300 113	11/19- inc. WLC 2.0 with preliminary setup inc. E- Jumpy / E- Spacetourer	S	FRE	C	E	D	L1	H	75	
Citroën Dospatch / SpaceTourer inc. towball	07/16-10/19	KIT		304 190 900 113		45	31.0	13.9	104	2500			included in the KIT 304 157 300 113	-10/19	S	CAN	C	E	D	L1	H	90	
Citroën Dospatch / SpaceTourer	07/16-10/19	KIT		335 106 900 113		60	28.5	13.9	104	2500			included in the KIT 304 157 300 113	-10/19	S	CAN	C	E	D	L1	H	90	













Citroën

Citroën Dospatch / SpaceTourer inc. È-Jumpy / È-SpaceTourer with preliminary setup inc. towball	11/19-	KIT		314 576 900 113			45	27.7	13.9	104	2500		included in the KIT 314 585 300 113		11/19- inc. WLC 2.0 with preliminary setup inc. È- Jumpy / È- Spacetourer	S	FRE	C	E	D	L1	H	75
Citroën Dospatch / SpaceTourer inc. È-Jumpy / È-SpaceTourer with preliminary setup	11/19-	KIT		314 578 900 113			60	27.2	13.9	104	2500		included in the KIT 314 585 300 113		11/19- inc. WLC 2.0 with preliminary setup inc. È- Jumpy / È- Spacetourer	S	FRE	C	E	D	L1	H	75
Citroën Nemo exc. vehicles with gas drive	02/08-12/15			306 349 600 001			150	16.5	7.5	75	1300		306 580 300 113			S	FRE	--	E	D1	L1	V	120
		KIT		306 349 900 113			150	18.5	7.5	75	1300		included in the KIT 306 580 300 113			S	FRE	--	E	D1	L1	V	120
Citroën Nemo inc. towball exc. vehicles with gas drive	02/08-12/15			306 351 600 001			150	17.0	7.5	75	1300		306 580 300 113			S	FRE	--	E	D1	L1	V	120



















Cupra Ateca KH7	09/18-			344 121 600 001		60	14.0	12.3	150	2500		305 407 300 113	with preliminary setup	S	CAN	C	E	D	L	H	30
				344 124 600 001		60	17.7	12.3	150	2500		305 408 300 107	→ without preliminary setup	S	CAN	C	E	--	--	V	60
												305 408 300 113	without preliminary setup	S	CAN	C	E	D	L	V	60
												305 438 300 113	inc. WLC 2.0 without preliminary setup	S	CAN	C	E	D	L1	V	90
												344 095 300 113	09/18- KH7 for vehicles with preparationg and integrated trailer control unit, for PR no. 1M7	S	CAN	--	E	D	L	H	30
Cupra Ateca KH7 without preliminary setup	09/18-	KIT		344 121 900 113		60	16.0	12.3	150	2500		included in the KIT 305 438 300 113	inc. WLC 2.0 without preliminary setup	S	CAN	C	E	D	L1	V	90
				344 124 900 113		60	19.6	12.3	150	2500		included in the KIT 305 438 300 113	inc. WLC 2.0 without preliminary setup	S	CAN	C	E	D	L1	V	90
Cupra Ateca KH7 with preliminary setup	09/18-	KIT		344 071 900 113		60	15.5	12.3	150	2500		included in the KIT 305 407 300 113	with preliminary setup	S	CAN	C	E	D	L	H	30
				344 072 900 113		60	19.2	12.3	150	2500		included in the KIT 305 407 300 113	with preliminary setup	S	CAN	C	E	D	L	H	30
Cupra Formentor KM7 exc. VZ5	11/20-			344 121 600 001		60	14.0	12.3	150	2500		305 408 300 107	→ without preliminary setup	S	CAN	C	E	--	--	V	60
				344 124 600 001		60	17.7	12.3	150	2500		305 408 300 113	without preliminary setup	S	CAN	C	E	D	L	V	60
												344 095 300 113	11/20- KM7 for vehicles with preparationg and integrated trailer control unit, for PR no. 1M7	S	CAN	--	E	D	L	H	30
Cupra Formentor KM7 without preliminary setup exc. VZ5	11/20-	KIT		344 121 900 113		60	16.0	12.3	150	2500		included in the KIT 305 438 300 113	inc. WLC 2.0 without preliminary setup	S	CAN	C	E	D	L1	V	90

Cupra

























Cupra Formentor KM7 without preliminary setup pas pour VZ5	11/20-	KIT		344 124 900 113		60	19.6	12.3	150	2500		included in the KIT 305 438 300 113	inc. WLC 2.0 without preliminary setup	S	CAN	C	E	D	L1	V	90
Cupra Leon IV KL1 inc. Hybrid Please check if there is a towing capacity in the car documents.	10/20-			305 605 600 001		60	19.4	9.0	109	2100		322 080 300 113 344 095 300 113	10/20- without preliminary setup 10/20- KL1 for vehicles with preparationg and integrated trailer control unit, for PR no. 1M7	S	CAN	C	E	D	L	V	120
Cupra Leon IV KL1 inc. Hybrid Please check if there is a towing capacity in the car documents.	10/20-			305 606 600 001		60	21.4	9.0	109	2100		322 080 300 113 344 095 300 113	10/20- without preliminary setup 10/20- KL1 for vehicles with preparationg and integrated trailer control unit, for PR no. 1M7	S	CAN	C	E	D	L	V	120
Cupra Leon IV Sportstourer KL8 inc. Hybrid	09/20-			305 605 600 001		60	19.4	9.0	109	2100		322 080 300 113 344 095 300 113	10/20- without preliminary setup 10/20- KL8 for vehicles with preparationg and integrated trailer control unit, for PR no. 1M7	S	CAN	C	E	D	L	V	120
Cupra Leon IV Sportstourer KL8 inc. Hybrid RECEPTION TUBE FOR TOWBALL VISIBLE	09/20-			305 606 600 001		60	21.4	9.0	109	2100		322 080 300 113 344 095 300 113	10/20- without preliminary setup 10/20- KL8 for vehicles with preparationg and integrated trailer control unit, for PR no. 1M7	S	CAN	C	E	D	L	V	120































DS 3 inc. Crossback Please check if there is a towing capacity in the car documents.	10/18-			304 216 600 001		90	25.0	7.1	61	1200		304 203 300 113	10/18-	S	A	C	E2	D1	L1	V	60
		KIT		304 216 900 113		90	26.6	7.1	61	1200		included in the KIT 304 203 300 113	10/18-	S	A	C	E2	D1	L1	V	60
DS 4	11/15-12/18			304 148 600 001		60	19.0	9.2	75	1550		304 144 300 113		S	CAN	C	E	D	L	V	90
		KIT		304 148 900 113		60	21.0	9.2	75	1550		included in the KIT 304 144 300 113		S	CAN	C	E	D	L	V	90
DS 4 Crossback				304 148 600 001		60	19.0	9.2	75	1550		304 144 300 113		S	CAN	C	E	D	L	V	90
		KIT		304 148 900 113		60	21.0	9.2	75	1550		included in the KIT 304 144 300 113		S	CAN	C	E	D	L	V	90
DS 5 exc. Hybrid	08/15-05/19			304 149 600 001		120	29.0	8.5	75	1500		304 144 300 113		S	CAN	C	E	D	L	V	90

Dacia

Dacia Dokker X67 exc. Stepway exc. vehicles with park distance control	11/12-12/21			316 333 600 001			60	19.5	7.3	75	1200		316 333 300 113				S	A	--	--	D1	L1	V	75
				316 334 600 001			60	19.5	7.3	75	1200													
		KIT		316 333 900 113			60	21.5	7.3	75	1200		included in the KIT 316 333 300 113				S	A	--	--	D1	L1	V	75
		KIT		316 334 900 113			60	21.5	7.3	75	1200		included in the KIT 316 333 300 113				S	A	--	--	D1	L1	V	75
Dacia Dokker Express exc. Stepway exc. vehicles with park distance control	11/12-12/21			316 333 600 001			60	19.5	7.3	75	1200		300 210 300 113				--	A	--	E1	D1	L1	V	90
				316 334 600 001			60	19.5	7.3	75	1200													
Dacia Duster I, SUV 4x2, 4x4	03/10-12/17			316 365 600 001			60	16.5	8.6	75	1600		316 366 300 113	-12/17			S	FRE		E2	D1	L1	V	90
				316 366 600 001			60	18.5	8.6	75	1600													
		KIT		316 365 900 113			60	20.6	8.6	75	1600		included in the KIT 316 366 300 113		-12/17		S	FRE		E2	D1	L1	V	90
		KIT		316 366 900 113			60	19.5	8.6	75	1600		included in the KIT 316 366 300 113		-12/17		S	FRE		E2	D1	L1	V	90
Dacia Duster II HM On 4x2 diesel models it is necessary to dismount the AdBlue tank. inc. facelift 2021-	12/17-			316 468 600 001			90	17.0	8.8	75	1500		316 497 300 113	12/17-			S	A	--		D1	L1	V	75
				316 366 600 001			60	18.5	8.6	75	1600													
Dacia Duster II HM On 4x2 diesel models it is necessary to dismount the AdBlue tank.	12/17-	KIT		316 468 900 113			90	18.1	17.0	75	1500		included in the KIT 316 497 300 113		12/17-		S	A	--		D1	L1	V	75
		KIT		316 469 900 113			60	19.1	8.6	75	1600		included in the KIT 316 497 300 113		12/17-		S	A	--		D1	L1	V	75



Dacia

Dacia Logan Symbol Saloon L52	01/13-12/20			316 343 600 001		90	14.0	6.5	75	1100	316 340 300 113				S	A	--	--	D1	L1	H	60	
				316 344 600 001		90	16.0	6.5	75	1100													
	KIT			316 343 900 113		90	15.0	6.5	75	1100	included in the KIT 316 340 300 113					S	A	--	--	D1	L1	H	60
		KIT			316 344 900 113		90	17.0	6.5	75	1100	included in the KIT 316 340 300 113				S	A	--	--	D1	L1	H	60
Dacia Logan Van Express exc. vehicles with gas drive exc. vehicles with park distance control	03/09-06/13			316 259 600 001		60	22.6	7.7	75	1300	316 259 300 113				S	C2	--	E1	D1	L1	V	45	
		KIT			316 259 900 113		60	24.6	7.7	75	1300	included in the KIT 316 259 300 113				S	C2	--	E1	D1	L1	V	45
Dacia Sandero inc. Stepway, exc. GPL	06/08-01/13			316 286 600 001		60	15.5	7.3	75	1355													
Dacia Sandero B52	01/13-12/16	KIT		316 343 900 113		90	15.0	6.5	75	1100	included in the KIT 316 340 300 113		-12/16		S	A	--	--	D1	L1	H	60	
		KIT		316 344 900 113		90	17.0	6.5	75	1100	included in the KIT 316 340 300 113		-12/16		S	A	--	--	D1	L1	H	60	
Dacia Sandero B52	01/13-01/21			316 343 600 001		90	14.0	6.5	75	1100	316 340 300 113		-12/16		S	A	--	--	D1	L1	H	60	
				316 344 600 001		90	16.0	6.5	75	1100	316 434 300 107		01/17-		S	A	--	E2	--	--	V	120	
				316 344 600 001		90	16.0	6.5	75	1100	316 434 300 113		01/17-		S	A	--	E2	D1	L1	V	120	
Dacia Sandero B52	01/17-01/21	KIT		316 434 900 113		90	17.5	6.5	75	1100	included in the KIT 316 434 300 113		01/17-		S	A	--	E2	D1	L1	V	120	
		KIT		316 435 900 113		90	19.5	6.5	75	1100	included in the KIT 316 434 300 113		01/17-		S	A	--	E2	D1	L1	V	120	

Dacia Sandero II Stepway exc. vehicles with GPL/gas drive	01/13-12/16	KIT		316 343 900 113		90	15.0	6.5	75	1100		included in the KIT 316 340 300 113	-12/16	S	A	--	--	D1	L1	H	60
		KIT		316 344 900 113		90	17.0	6.5	75	1100		included in the KIT 316 340 300 113	-12/16	S	A	--	--	D1	L1	H	60
Dacia Sandero II Stepway exc. vehicles with GPL/gas drive	01/13-12/20			316 343 600 001		90	14.0	6.5	75	1100		316 340 300 113	-12/16	S	A	--	--	D1	L1	H	60
				316 344 600 001		90	16.0	6.5	75	1100		316 434 300 107	01/17-	S	A	--	E2	--	--	V	120
				316 434 300 113		90	17.5	6.5	75	1100		316 434 300 113	01/17-	S	A	--	E2	D1	L1	V	120
Dacia Sandero II Stepway exc. vehicles with GPL/gas drive	01/17-12/20	KIT		316 434 900 113		90	17.5	6.5	75	1100		included in the KIT 316 434 300 113	01/17-	S	A	--	E2	D1	L1	V	120
		KIT		316 435 900 113		90	19.5	6.5	75	1100		included in the KIT 316 434 300 113	01/17-	S	A	--	E2	D1	L1	V	120
Dacia Sandero III exc. LPG	01/21-			316 490 600 001		90	22.4	7.0	85	1100		316 482 300 113	01/21-	S	A	C1	E2	D	L1	V	60
				316 491 600 001		90	22.7	7.0	85	1100											
		KIT		316 490 900 113		90	22.3	7.0	85	1100		included in the KIT 316 482 300 113	01/21-	S	A	C1	E2	D	L1	V	60
		KIT		316 491 900 113		90	24.6	7.0	85	1100		included in the KIT 316 482 300 113	01/21-	S	A	C1	E2	D	L1	V	60
Dacia Sandero III Stepway exc. LPG	01/21-			316 490 600 001		90	22.4	7.0	85	1100		316 482 300 113	01/21-	S	A	C1	E2	D	L1	V	60
				316 491 600 001		90	22.7	7.0	85	1100											
		KIT		316 490 900 113		90	22.3	7.0	85	1100		included in the KIT 316 482 300 113	01/21-	S	A	C1	E2	D	L1	V	60
		KIT		316 491 900 113		90	24.6	7.0	85	1100		included in the KIT 316 482 300 113	01/21-	S	A	C1	E2	D	L1	V	60

























Daihatsu

Daihatsu Charade	05/11-01/13			335 455 600 001		75	18.7	6.8	50	1150		335 383 300 113			S	FRE	--	--	D1	L1	V	120
		KIT		335 383 900 113		75	20.7	6.8	50	1150		included in the KIT 335 383 300 113			S	FRE	--	--	D1	L1	V	120











Dodge Journey, JC 49	01/08-12/20		342 199 600 001		90	15.8	9.6	80	1600	300 078 300 113				--	FRE	--	--	D1	L1	V		
Dodge Nitro fits SXT with 20" spare wheel but not SRT	03/08-12/12		342 131 600 001		90	30.0	15.3	140	3500	300 210 300 113				--	A	--	E1	D1	L1	V	90	







Dodge

Fiat



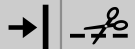
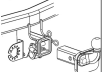
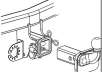







Fiat 500 inc. Convertible exc. Abarth - 135 HP exc. 500S exc. ELECTRIC	07/07-			306 503 600 001		60	14.8	5.1	60	800		306 311 300 113	07/15-	S	FRE	--	E	D1	--	V	105	
Fiat 500 inc. Convertible exc. Abarth - 135 HP exc. ELECTRIC	07/07-			306 506 600 001		60	18.0	5.0	60	800		306 311 300 113	07/15-	S	FRE	--	E	D1	--	V	105	
Fiat 500 inc. Convertible exc. Abarth - 135 HP exc. 500S exc. ELECTRIC	07/15-	KIT		306 503 900 113		60	15.9	5.1	60	800		included in the KIT 306 311 300 113	07/15-	S	FRE	--	E	D1	--	V	105	
Fiat 500 inc. Convertible exc. Abarth - 135 HP exc. ELECTRIC	07/15-	KIT		306 506 900 113		60	19.1	5.0	60	800		included in the KIT 306 311 300 113	07/15-	S	FRE	--	E	D1	--	V	105	
Fiat 500 L inc. Trekking and Living exc. Cross	10/12-06/17			306 401 600 001		60	18.0	7.5	90	1200		306 397 300 113		S	FRE	--	E	D1	L1	V	120	
				306 400 600 001		60	21.0	7.5	90	1200												
		KIT		306 401 900 113		60	20.0	7.5	90	1200		included in the KIT 306 397 300 113		S	FRE	--	E	D1	L1	V	120	
		KIT		306 400 900 113		60	23.0	7.5	90	1200		included in the KIT 306 397 300 113		S	FRE	--	E	D1	L1	V	120	
Fiat 500 S inc. Convertible exc. Abarth - 135 HP	02/16-			306 505 600 001		60	15.0	5.0	60	800		306 311 300 113		S	FRE	--	E	D1	--	V	105	
				306 506 600 001		60	18.0	5.0	60	800												
		KIT		306 505 900 113		60	16.0	5.0	60	800		included in the KIT 306 311 300 113		S	FRE	--	E	D1	--	V	105	
		KIT		306 506 900 113		60	19.1	5.0	60	800		included in the KIT 306 311 300 113		S	FRE	--	E	D1	--	V	105	

Fiat























Fiat Doblò L1 510, 511 inc. E-Doblò	06/22-	 304 207 600 001			60	20.0	8.6	75	1500		314 594 300 113		06/22- Doblò	inc. E-	S	A	C	E	D	L	V	90	
					 304 209 600 001	60	20.5	8.6	75						1500								
		KIT	 304 207 900 113			60	21.2	8.6	75	1500		included in the KIT 314 594 300 113		06/22- Doblò	inc. E-	S	A	C	E	D	L	V	90
			 304 209 900 113			60	21.8	8.6	75	1500		included in the KIT 314 594 300 113		06/22- Doblò	inc. E-	S	A	C	E	D	L	V	90
Fiat Doblò L2 510, 511 inc. E-Doblò	06/22-	 304 210 600 001			60	21.0	8.6	75	1500		314 594 300 113		06/22- Doblò	inc. E-	S	A	C	E	D	L	V	90	
					 304 212 600 001	60	21.5	8.6	75						1500								
		KIT	 304 210 900 113			60	22.2	8.6	75	1500		included in the KIT 314 594 300 113		06/22- Doblò	inc. E-	S	A	C	E	D	L	V	90
			 304 212 900 113			60	22.8	8.6	75	1500		included in the KIT 314 594 300 113		06/22- Doblò	inc. E-	S	A	C	E	D	L	V	90
Fiat Ducato Van inc. towball	02/95-06/06	 306 329 600 001	→		60	29.0	12.5	130	2000														
Fiat Ducato Van For vehicles with long superstructure L4/XL please order separately a set distance tubes to strengthen the framework, no. 906270650003. Some vehicles 03/08- do not have chassis bores. In this case it is necessary to bore them subsequent. For the mounting time will last 120 min. longer.	06/06-	 306 491 600 001			120	32.0	16.9	150	3000		306 510 300 113		-02/11 chassis no. 1948840	S	FRE	--	E	D1	L1	V	105		
						306 553 300 113	02/11- from chassis no. 1948841	S	FRE		--		E	D1	L1	V	105						









Fiat Ducato Van inc. towball For vehicles with long superstructure L4/XL please order separately a set distance tubes to strengthen the framework, no. 906270650003. Some vehicles 03/08- do not have chassis bores. In this case it is necessary to bore them subsequent. For the mounting time will last 120 min. longer.	06/06-		306 490 600 001		120	32.0	16.9	150	3000	306 510 300 113	-02/11 chassis no. 1948840	S	FRE	--	E	D1	L1	V	105	
														306 553 300 113	02/11- from chassis no. 1948841	S	FRE	--	E	D1
Fiat Ducato Van inc. towball Some vehicles 03/08- do not have chassis bores. In this case it is necessary to bore them subsequent. For the mounting time will last 120 min. longer.	06/06-		306 357 600 001	 	60	29.0	15.8	150	3000	306 510 300 113	-02/11 chassis no. 1948840	S	FRE	--	E	D1	L1	V	105	
														306 553 300 113	02/11- from chassis no. 1948841	S	FRE	--	E	D1
Fiat Ducato Van inc. towball for vehicles up to 6 m long 51 mm square holder	06/06-		306 563 600 001		60	25.7	15.1	100	2500	306 510 300 113	-02/11 chassis no. 1948840	S	FRE	--	E	D1	L1	V	105	
													306 553 300 113	02/11- from chassis no. 1948841	S	FRE	--	E	D1	L1
Fiat Ducato Van For vehicles with long superstructure L4/XL please order separately a set distance tubes to strengthen the framework, no. 906270650003. Some vehicles 03/08- do not have chassis bores. In this case it is necessary to bore them subsequent. For the mounting time will last 120 min. longer.	06/06-02/11	KIT		306 271 900 113		120	34.0	16.9	150	3000	included in the KIT 306 510 300 113	-02/11 chassis no. 1948840	S	FRE	--	E	D1	L1	V	105
Fiat Ducato Van inc. towball For vehicles with long superstructure L4/XL please order separately a set distance tubes to strengthen the framework, no. 906270650003. Some vehicles 03/08- do not have chassis bores. In this case it is necessary to bore them subsequent. For the mounting time will last 120 min. longer.	06/06-02/11	KIT		306 330 900 113		120	34.0	16.9	150	3000	included in the KIT 306 510 300 113	-02/11 chassis no. 1948840	S	FRE	--	E	D1	L1	V	105

Fiat





Fiat Ducato Van For vehicles with long superstructure L4/XL please order separately a set distance tubes to strengthen the framework, no. 906270650003. Some vehicles 03/08- do not have chassis bores. In this case it is necessary to bore them subsequent. For the mounting time will last 120 min. longer.	02/11-	KIT		306 491 900 113		120	32.8	16.9	150	3000				included in the KIT 306 553 300 113		02/11- from chassis no. 1948841	S	FRE	--	E	D1	L1	V	105
Fiat Ducato Van inc. towball For vehicles with long superstructure L4/XL please order separately a set distance tubes to strengthen the framework, no. 906270650003. Some vehicles 03/08- do not have chassis bores. In this case it is necessary to bore them subsequent. For the mounting time will last 120 min. longer.	02/11-	KIT		306 490 900 113		120	32.2	16.9	150	3000				included in the KIT 306 553 300 113		02/11- from chassis no. 1948841	S	FRE	--	E	D1	L1	V	105
Fiat Ducato Van inc. towball Some vehicles 03/08- do not have chassis bores. In this case it is necessary to bore them subsequent. For the mounting time will last 120 min. longer.	02/11-	KIT		306 553 900 113	→ 	>150	31.0	15.8	150	3000				included in the KIT 306 553 300 113		02/11- from chassis no. 1948841	S	FRE	--	E	D1	L1	V	105
Fiat Ducato Chassis Cab inc. towball	02/95-06/06			306 329 600 001	→	60	29.0	12.5	130	2000			300 052 300 113 300 060 300 113		03/02- 03/02-	--	FRE	--	E1	D1	--	V		
Fiat Ducato Chassis Cab inc. towball For vehicles with long superstructure L4/XL please order separately a set distance tubes to strengthen the framework, no. 906270650003.	06/06-			306 492 600 001		120	35.0	15.9	150	3000			306 531 300 113			S	FRE	--	E1	D	--	V	90	
Fiat Ducato Chassis Cab inc. towball For vehicles with long superstructure L4/XL please order separately a set distance tubes to strengthen the framework, no. 906270650003.	06/06-	KIT		306 318 900 113		120	37.0	15.9	150	3000				included in the KIT 306 531 300 113			S	FRE	--	E1	D	--	V	90
Fiat Ducato Chassis Cab inc. towball	06/06-			306 357 600 001	→ 	60	29.0	15.8	150	3000				306 531 300 113			S	FRE	--	E1	D	--	V	90

Fiat























Fiat Panda front wheel drive exc. vehicles with gas drive (LPG/ CNG)	02/12-			306 394 600 001	→ 	60	19.5	6.1	70	1000		306 394 300 113			S	FRE	--	E	D1	--	V	105	
		KIT		306 385 900 113		60	21.0	6.1	70	1000		included in the KIT 306 394 300 113			S	FRE	--	E	D1	--	V	105	
		KIT		306 394 900 113	→ 	60	21.5	6.1	70	1000		included in the KIT 306 394 300 113			S	FRE	--	E	D1	--	V	105	
Fiat Panda 4x4 inc. Trekking exc. vehicles with gas drive (LPG/ CNG)	10/12-05/22			306 388 600 001		60	18.0	5.8	60	900		306 394 300 113		-05/22	S	FRE	--	E	D1	--	V	105	
				306 389 600 001		60	19.5	5.8	60	900													
		KIT		306 388 900 113		60	21.0	5.8	60	900		included in the KIT 306 394 300 113		-05/22	S	FRE	--	E	D1	--	V	105	
		KIT		306 389 900 113		60	22.0	5.8	60	900		included in the KIT 306 394 300 113		-05/22	S	FRE	--	E	D1	--	V	105	
Fiat Panda Cross Vehicles with gas drive are not permitted to tow by manufacturer.	10/14-			306 388 600 001		60	18.0	5.8	60	900		306 394 300 113			S	FRE	--	E	D1	--	V	105	
				306 389 600 001		60	19.5	5.8	60	900													
		KIT		306 388 900 113		60	21.0	5.8	60	900		included in the KIT 306 394 300 113			S	FRE	--	E	D1	--	V	105	
		KIT		306 389 900 113		60	22.0	5.8	60	900		included in the KIT 306 394 300 113			S	FRE	--	E	D1	--	V	105	









Fiat Punto EVO	10/09-08/18			306 375 600 001		90	19.0	6.7	75	1100		300 078 300 113	10/09-08/18	--	FRE	--	--	D1	L1	V			
				306 374 600 001		90	19.0	6.7	75	1100		306 375 300 113		S	CAN	--	E	D	--	V	105		
		KIT		306 375 900 113		90	21.0	6.7	75	1100		included in the KIT 306 375 300 113		S	CAN	--	E	D	--	V	105		
		KIT		306 374 900 113		90	21.0	6.7	75	1100		included in the KIT 306 375 300 113		S	CAN	--	E	D	--	V	105		
Fiat Qubo / Qubo Trekking (225) exc. vehicles with gas drive	02/08-			306 349 600 001		150	16.5	7.5	75	1300		306 580 300 113		S	FRE	--	E	D1	L1	V	120		
		KIT		306 349 900 113		150	18.5	7.5	75	1300		included in the KIT 306 580 300 113		S	FRE	--	E	D1	L1	V	120		
Fiat Qubo / Qubo Trekking (225) inc. towball exc. vehicles with gas drive	02/08-			306 351 600 001		150	17.0	7.5	75	1300		306 580 300 113		S	FRE	--	E	D1	L1	V	120		
Fiat Scudo	01/07-06/16			306 331 600 001		75	22.5	12.2	122	2200		304 400 300 113		S	CAN	C1	E	D	L1	H	105		
				306 333 600 001		75	22.5	12.2	122	2200													
		KIT		306 331 900 113		75	22.5	12.2	122	2200		included in the KIT 304 400 300 113		S	CAN	C1	E	D	L1	H	105		
		KIT		306 333 900 113		75	24.5	12.2	122	2200		included in the KIT 304 400 300 113		S	CAN	C1	E	D	L1	H	105		

Fiat

Fiat Tipo Hatchback exc. Tipo Sport exc. vehicles with rear LED lights	09/16-	KIT		306 405 900 113		90	23.3	8.7	60	1500		included in the KIT 306 469 300 113	exc. vehicles with rear LED lights	S	FRE	--	E	D1	L1	V	120	
Fiat Tipo Hatchback exc. Tipo Sport for vehicles with rear LED lights	04/21-	KIT		306 408 900 113		90	24.2	8.7	60	1200		included in the KIT 306 470 300 113	04/21- for vehicles with rear LED lights	S	FRE	--	--	D1	L1	V	120	



























Ford























Ford B-Max	09/12-09/17			307 333 600 001			70	19.5	6.8	65	900		307 397 300 107			S	A	--	E	--	--	V	60
Ford B-Max exc. vehicles with park distance control	09/12-09/17			307 397 600 001			70	18.5	6.8	65	900		307 397 300 107			S	A	--	E	--	--	V	60
Ford C-Max without preliminary setup	09/10-06/19	KIT		307 402 900 113			60	21.0	10.0	90	1800		included in the KIT 307 402 300 113			S	CAN	C	E	D	L1	H	45
Ford C-Max without preliminary setup	09/10-06/19	KIT		307 441 900 113			60	23.0	10.0	90	1800		included in the KIT 307 402 300 113			S	CAN	C	E	D	L1	H	45
Ford C-Max	09/10-06/19			307 508 600 001			60	19.2	10.0	90	1800		307 402 300 107 307 402 300 113			S	CAN	C	E	--	--	H	45
				307 507 600 001			60	25.0	10.0	90	1800		307 539 300 113		06/15- for vehicles with preparation	S	FRE	C	E2	D	L1	H	90
Ford C-Max for vehicles with preparation	06/15-06/19	KIT		307 508 900 113			60	23.0	10.0	90	1800		included in the KIT 307 539 300 113		06/15- for vehicles with preparation	S	FRE	C	E2	D	L1	H	90
		KIT		307 507 900 113			60	29.0	10.0	90	1800		included in the KIT 307 539 300 113		06/15- for vehicles with preparation	S	FRE	C	E2	D	L1	H	90
Ford Ecosport exc. 4 WD only for vehicles with holes in the vehicle frame	10/17-12/22			307 636 600 001			60	21.7	7.0	80	1100		307 489 300 113		10/17- with preliminary setup, inc. WLC 2.0	S	FRE	C	E2	D	L1	H	60
				307 637 600 001			60	24.8	7.0	80	1100												
Ford Ecosport with preliminary setup exc. 4 WD only for vehicles with holes in the vehicle frame	10/17-12/22	KIT		307 636 900 113			60	23.3	7.0	80	1100		included in the KIT 307 489 300 113		10/17- with preliminary setup, inc. WLC 2.0	S	FRE	C	E2	D	L1	H	60
		KIT		307 637 900 113			60	26.4	7.0	80	1100		included in the KIT 307 489 300 113		10/17- with preliminary setup, inc. WLC 2.0	S	FRE	C	E2	D	L1	H	60
Ford Edge	07/16-			307 495 600 001			90	28.5	11.6	90	2200		307 495 300 113			S	CAN	C	E	D	L1	H	45
		KIT		307 495 900 113			90	30.9	11.6	90	2200		included in the KIT 307 495 300 113			S	CAN	C	E	D	L1	H	45

Ford Fiesta exc. ST / 150 HP Please check if there is a towing capacity in the car documents.	04/02-10/08		307 283 600 001		75	13.7	6.3	75	1050		300 072 300 107	-10/05	--	FRE	--	--	--	--	V		
											300 072 300 113	-10/05	--	FRE	--	--	D1	L1	V		
											307 122 300 113	11/05-	S	FRE	--	E	D1	L	V	90	
Ford Fiesta exc. ST / 150 HP Please check if there is a towing capacity in the car documents.	11/05-10/08	KIT		307 283 900 113		75	15.7	6.3	75	1050		included in the KIT 307 122 300 113	11/05-	S	FRE	--	E	D1	L	V	90
Ford Fiesta exc. Titanium, Sport, Zetec S inc. Fiesta Van 2011-	10/08-06/17		307 363 600 001		90	14.0	6.5	50	1100		307 123 300 113	02/13-06/17	S	FRE	--	--	D1	L1	H	60	
																					
Ford Fiesta exc. Titanium, Sport, Zetec S inc. Fiesta Van 2011-	02/13-06/17	KIT		307 365 900 113		90	14.0	6.5	50	1100		included in the KIT 307 123 300 113	02/13-06/17	S	FRE	--	--	D1	L1	H	60
		KIT		307 341 900 113		90	19.0	6.5	50	1100		included in the KIT 307 123 300 113	02/13-06/17	S	FRE	--	--	D1	L1	H	60
Ford Fiesta MK8 Vehicles with electric panoramic sunroof: towbar only for vehicles with 1.1 l engines	07/17-07/23		307 658 600 001		75	19.6	6.1	65	1000		307 599 300 113	07/17-07/23 inc. WLC 2.0	S	A	C1	E2	D1	L1	V	90	
																					
		KIT		307 599 900 113		75	21.4	6.1	65	1000		included in the KIT 307 599 300 113	07/17-07/23 inc. WLC 2.0	S	A	C1	E2	D1	L1	V	90
		KIT		307 600 900 113		75	24.2	6.1	65	1000		included in the KIT 307 599 300 113	07/17-07/23 inc. WLC 2.0	S	A	C1	E2	D1	L1	V	90























Ford























Ford

Ford Fiesta ST-Line MK8 Vehicles with electric panoramic sunroof: towbar only for models with 1.1 l engines	07/17-07/23			307 658 600 001		75	19.6	6.1	65	1000		307 599 300 113	07/17-	S	A	C1	E2	D1	L1	V	90	
				307 659 600 001		75	22.4	6.1	65	1000												
	KIT		307 599 900 113		75	21.4	6.1	65	1000		included in the KIT 307 599 300 113	07/17-	S	A	C1	E2	D1	L1	V	90		
	KIT		307 600 900 113		75	24.2	6.1	65	1000		included in the KIT 307 599 300 113	07/17-	S	A	C1	E2	D1	L1	V	90		
Ford Fiesta Van exc. ST / 150 HP	07-12/10			307 283 600 001		75	13.7	6.3	75	1050		307 122 300 113		S	FRE	--	E	D1	L	V	90	
		KIT		307 283 900 113		75	15.7	6.3	75	1050		included in the KIT 307 122 300 113		S	FRE	--	E	D1	L	V	90	
Ford Focus C-Max Van	10/03-11/10			307 264 600 001		120	21.0	8.7	75	1590		307 264 300 113		S	FRE	--	E	D1	--	H	45	
				343 038 600 001		90	21.5	8.7	75	1590												
	KIT		307 438 900 113		120	23.0	8.7	75	1590		included in the KIT 307 264 300 113		S	FRE	--	E	D1	--	H	45		
	KIT		307 407 900 113		90	22.5	8.7	75	1590		included in the KIT 307 264 300 113		S	FRE	--	E	D1	--	H	45		
Ford Focus Coupé-Convertible fits CC-3 and CC3D turbo models	04/07-09/10			343 038 600 001		90	21.5	8.7	75	1590		300 072 300 107 300 072 300 113		--	FRE	--	--	--	--	V		
													--	FRE	--	--	D1	L1	V			
Ford Focus Hatchback exc. ST / 225 HP, exc. RS / 300 HP	10/04-01/08	KIT		307 454 900 113	→ 	120	23.0	8.7	75	1590		included in the KIT 307 231 300 113	→	-01/08	S	FRE	--	E	D1	--	H	60
		KIT		307 453 900 113	→ 	120	23.5	8.7	75	1590		included in the KIT 307 231 300 113	→	-01/08	S	FRE	--	E	D1	--	H	60

















Ford Focus Hatchback exc. ST / 225 HP, exc. RS / 300 HP inc. vehicles 01/08-	10/04-03/11			307 264 600 001		120	21.0	8.7	75	1590		307 231 300 113		-01/08	S	FRE	--	E	D1	--	H	60
				343 038 600 001		90	21.5	8.7	75	1590												
Ford Focus Hatchback 06/12-: With vehicles with 1,0 GTDi motor it could be possible that an additional water pump is necessary. Please find details in TSB 35/2012. exc. EcoBoost S / Individual Styling Package inc. facelift 11/2014-	03/11-08/18			307 459 600 001		60	21.0	10.0	90	1500		307 402 300 107			S	CAN	C	E	--	--	H	45
				307 461 600 001			60	21.0	9.5	90												
Ford Focus Hatchback without preliminary setup 06/12-: With vehicles with 1,0 GTDi motor it could be possible that an additional water pump is necessary. Please find details in TSB 35/2012. exc. EcoBoost S / Individual Styling Package inc. facelift 11/2014-	03/11-08/18	KIT		307 459 900 113		60	23.0	10.0	75	1500		included in the KIT 307 402 300 113			S	CAN	C	E	D	L1	H	45
				307 461 900 113			60	23.0	10.0	75												
Ford Focus Hatchback HN 5 doors inc. ST-Line inc. Activ	09/18-			307 652 600 001		60	21.7	9.5	90	1800		307 489 300 113		09/18- with preliminary setup, inc. WLC 2.0	S	FRE	C	E2	D	L1	H	60
				307 653 600 001		60	24.7	9.5	90	1800												
Ford Focus Hatchback HN without preliminary setup 5 doors inc. ST-Line inc. Activ	09/18-	KIT		307 652 900 113		60	23.4	9.5	90	1800		included in the KIT 307 490 300 113		09/18- without preliminary setup, inc. WLC 2.0	S	CAN	C	E	D	L1	V	75
				307 653 900 113		60	26.4	9.5	90	1800												
Ford Focus Hatchback Active HP 5 doors	01/19-			307 652 600 001		60	21.7	9.5	90	1800		307 489 300 113		01/19- with preliminary setup, inc. WLC 2.0	S	FRE	C	E2	D	L1	H	60
				307 653 600 001		60	24.7	9.5	90	1800												

Ford

























Ford Focus Hatchback Active HP without preliminary setup 5 doors	01/19-	KIT		307 652 900 113		60	23.4	9.5	90	1800	included in the KIT 307 490 300 113	01/19- without preliminary setup, inc. WLC 2.0	S	CAN	C	E	D	L1	V	75
		KIT		307 653 900 113		60	26.4	9.5	90	1800	included in the KIT 307 490 300 113	01/19- without preliminary setup, inc. WLC 2.0	S	CAN	C	E	D	L1	V	75
Ford Focus Estate exc. ST / 225 HP	03/05-04/11			307 337 600 001		150	20.5	8.5	75	1500	300 072 300 113	for vehicles without central plug connection	--	FRE	--	--	D1	L1	V	
Ford Focus Estate exc. ST / 225 HP Please order separately: foam carrier for antenna for vehicles with keyless entry, order no. 907456630001. 06/12-: With vehicles with 1,0 GTDi motor it could be possible that an additional water pump is necessary. Please find details in TSB 35/2012 exc. EcoBoost S / Individual Styling Package inc. facelift 11/2014-	04/11-08/18			307 456 600 001		90	23.0	10.0	90	1500	307 402 300 107		S	CAN	C	E	--	--	H	45
				307 458 600 001		90	24.0	10.0	90	1500	307 402 300 113		S	CAN	C	E	D	L1	H	45
Ford Focus Estate without preliminary setup exc. ST / 225 HP Please order separately: foam carrier for antenna for vehicles with keyless entry, order no. 907456630001. 06/12-: With vehicles with 1,0 GTDi motor it could be possible that an additional water pump is necessary. Please find details in TSB 35/2012 exc. EcoBoost S / Individual Styling Package inc. facelift 11/2014-	04/11-08/18	KIT		307 456 900 113		90	25.0	10.0	90	1500	included in the KIT 307 402 300 113		S	CAN	C	E	D	L1	H	45
		KIT		307 458 900 113		90	26.0	10.0	90	1500	included in the KIT 307 402 300 113		S	CAN	C	E	D	L1	H	45
Ford Focus Estate HP inc. ST-Line exc. Active exc. Vignale	09/18-			307 652 600 001		60	21.7	9.5	90	1800	307 489 300 113	09/18- with preliminary setup, inc. WLC 2.0	S	FRE	C	E2	D	L1	H	60
				307 653 600 001		60	24.7	9.5	90	1800	307 490 300 113	09/18- without preliminary setup, inc. WLC 2.0	S	CAN	C	E	D	L1	V	75
Ford Focus Estate HP without preliminary setup inc. ST-Line exc. Active exc. Vignale	09/18-	KIT		307 652 900 113		60	23.4	9.5	90	1800	included in the KIT 307 490 300 113	09/18- without preliminary setup, inc. WLC 2.0	S	CAN	C	E	D	L1	V	75
		KIT		307 653 900 113		60	26.4	9.5	90	1800	included in the KIT 307 490 300 113	09/18- without preliminary setup, inc. WLC 2.0	S	CAN	C	E	D	L1	V	75







Ford Fusion exc. vehicles with park distance control exc. Calero	04/02-12/12			307 289 600 001		75	15.8	6.3	75	1050		300 072 300 107 300 072 300 113 307 122 300 113				--	FRE	--	--	--	--	V			
Ford Fusion exc. vehicles with park distance control exc. Calero	11/05-12/12	KIT		307 289 900 113		75	17.8	6.3	75	1050		included in the KIT 307 122 300 113		11/05-		S	FRE	--	E	D1	L	V	90		
Ford Galaxy thermal-insulation plate inc. inc. 4WD bumper bracket is not necessary	05/00-06			321 665 600 001		90	24.0	12.5	100	2500		321 458 300 113				S	FRE	--	E	D1	L1	H	60		
		KIT		321 665 900 113		90	26.0	12.5	100	2500		included in the KIT 321 458 300 113				S	FRE	--	E	D1	L1	H	60		
Ford Galaxy 7 seater without height control	05/06-09/15			307 306 600 001		90	17.0	12.1	90	2000		307 400 300 113				S		C	E	D	L1		45		
				307 355 600 001		90	19.5	12.1	90	2000															
		KIT		307 306 900 113		90	19.0	11.1	90	2000		included in the KIT 307 400 300 113				S		C	E	D	L1		45		
		KIT		307 355 900 113		90	21.5	11.1	90	2000		included in the KIT 307 400 300 113				S		C	E	D	L1		45		
Ford Galaxy III 7 seater CK without height control exc. vehicles with tailgate that opens by sensor (foot sensor) inc. Plugin-Hybrid	09/15-04/23			307 496 600 001		90	20.0	12.1	90	2000		307 499 300 113				S	A	C1	E2	D1	L1	H	60		
		KIT		307 496 900 113		90	24.0	12.1	90	2000		included in the KIT 307 499 300 113				S	A	C1	E2	D1	L1	H	60		
Ford Galaxy III 7 seater CK without height control Please order separately cover for bumper cutout at Ford dealer's. exc. vehicles with tailgate that opens by sensor (foot sensor) inc. Plugin-Hybrid	09/15-04/23			307 497 600 001		90	20.0	12.1	90	2000		307 499 300 113				S	A	C1	E2	D1	L1	H	60		
		KIT		307 497 900 113		90	27.0	12.1	90	2000		included in the KIT 307 499 300 113				S	A	C1	E2	D1	L1	H	60		

Ford

Ford Galaxy III 7 seater CK with height control Please order separately cover for bumper cutout at Ford dealer' s. exc. vehicles with tailgate that opens by sensor (foot sensor) inc. Plugin-Hybrid	09/15-04/23			307 498 600 001 →		90	20.0	12.1	90	2000		307 499 300 113		S	A	C1	E2	D1	L1	H	60
Ford Grand C-Max without preliminary setup inc. Titanium	09/10-06/19	KIT		307 402 900 113		60	21.0	10.0	90	1800	included in the KIT 307 402 300 113		S	CAN	C	E	D	L1	H	45	
Ford Grand C-Max inc. Titanium	09/10-06/19	KIT		307 441 900 113		60	23.0	10.0	90	1800	included in the KIT 307 402 300 113		S	CAN	C	E	D	L1	H	45	
Ford Grand C-Max inc. Titanium	09/10-06/19			307 508 600 001		60	19.2	10.0	90	1800	307 402 300 107 307 402 300 113		S	CAN	C	E	--	--	H	45	
Ford Grand C-Max inc. Titanium for vehicles with preparation	09/10-06/19			307 507 600 001		60	25.0	10.0	90	1800	307 539 300 113	06/15- for vehicles with preparation	S	FRE	C	E2	D	L1	H	90	
Ford Grand C-Max inc. Titanium for vehicles with preparation	06/15-06/19	KIT		307 508 900 113		60	23.0	10.0	90	1800	included in the KIT 307 539 300 113	06/15- for vehicles with preparation	S	FRE	C	E2	D	L1	H	90	
Ford KA+	06/16-01/20			307 658 600 001		75	19.6	6.1	65	1000	307 576 300 113	-01/20 inc. WLC 2.0	S	A	C1	E	D1	--	V	90	
				307 659 600 001		75	22.4	6.1	65	1000											
		KIT		307 658 900 113		75	20.7	6.1	65	1000	included in the KIT 307 576 300 113	-01/20 inc. WLC 2.0	S	A	C1	E	D1	--	V	90	
		KIT		307 659 900 113		90	23.6	6.1	65	1000	included in the KIT 307 576 300 113	-01/20 inc. WLC 2.0	S	A	C1	E	D1	--	V	90	

























Ford















Ford Kuga III exc. vehicles with tailgate that opens by sensor (foot sensor)	07/19-	KIT		307 672 900 113		100	32.0	10.8	100	2100			included in the KIT 307 001 300 153	07/19- not available separately Wiring kit: for vehicles with pre-equipment: rear connection, for vehicles without pre-equipment: front connection	S	A	C	E	D	L1		60	
Ford Mondeo Estate inc. vehicles with height control exc. ST220	11/00-06/07			307 431 600 001		120	19.0	11.0	85	2000													
Ford Mondeo Estate exc. vehicles with height control	06/07-12/14			307 403 600 001		150	17.5	11.6	90	2120			307 400 300 113		S		C	E	D	L1		45	
				307 455 600 001		150	19.5	11.6	90	2120													
		KIT		307 403 900 113		150	19.5	11.6	90	2120			included in the KIT 307 400 300 113		S		C	E	D	L1		45	
		KIT		307 455 900 113		150	21.5	11.6	90	2120			included in the KIT 307 400 300 113		S		C	E	D	L1		45	
Ford Mondeo V Saloon/ Hatchback 4/5 doors exc. vehicles with height control, exc. for "Vignale"	01/15-04/22			307 475 600 001		90	22.5	11.9	100	2500			307 478 300 113		S	A	C1	E2	D1	L1	H	90	
		KIT		307 475 900 113		90	24.5	11.9	100	2500			included in the KIT 307 478 300 113		S	A	C1	E2	D1	L1	H	90	
Ford Mondeo V Saloon/ Hatchback 4/5 doors inc. vehicles with height control, exc. for "Vignale"	01/15-04/22			307 476 600 001		90	25.0	11.9	100	2500			307 478 300 113		S	A	C1	E2	D1	L1	H	90	
		KIT		307 476 900 113		90	27.0	11.9	100	2500			included in the KIT 307 478 300 113		S	A	C1	E2	D1	L1	H	90	
Ford Mondeo V Turnier exc. vehicles with height control, exc. for "Vignale"	01/15-04/22			307 475 600 001		90	22.5	11.9	100	2500			307 478 300 113		S	A	C1	E2	D1	L1	H	90	
		KIT		307 475 900 113		90	24.5	11.9	100	2500			included in the KIT 307 478 300 113		S	A	C1	E2	D1	L1	H	90	

Ford Mondeo V Turnier inc. vehicles with height control, exc. for "Vignale"	01/15-04/22			307 476 600 001		90	25.0	11.9	100	2500		307 478 300 113			S	A	C1	E2	D1	L1	H	90
		KIT		307 476 900 113		90	27.0	11.9	100	2500		included in the KIT 307 478 300 113			S	A	C1	E2	D1	L1	H	90
Ford Mustang Mach-E CGW	07/21-			307 673 600 001		60	16.7	5.7	30	750		307 490 300 113	07/21- without preliminary setup		S	CAN	C	E	D	L1	V	75
		KIT		307 673 900 113		60	18.7	5.7	30	750		included in the KIT 307 490 300 113	07/21- without preliminary setup		S	CAN	C	E	D	L1	V	75
Ford Puma	09/19-			307 640 600 001		70	19.5	7.5	90	1100		307 489 300 113	with preliminary setup, inc. WLC 2.0		S	FRE	C	E2	D	L1	H	60
				307 641 600 001		75	22.0	7.5	90	1100		307 490 300 113	without preliminary setup, inc. WLC 2.0		S	CAN	C	E	D	L1	V	75
Ford Puma without preliminary setup	09/19-	KIT		307 640 900 113		75	21.0	7.5	90	1100		included in the KIT 307 490 300 113	without preliminary setup, inc. WLC 2.0		S	CAN	C	E	D	L1	V	75
		KIT		307 641 900 113		75	23.9	7.5	90	1100		included in the KIT 307 490 300 113	without preliminary setup, inc. WLC 2.0		S	CAN	C	E	D	L1	V	75
Ford Ranger III towball inc. for vehicles with integrated step in the bumper	03/12-02/16	KIT		307 613 900 113		30	35.6	16.4	225	3500		included in the KIT 343 069 300 113	-02/16		S	CAN	C	E	D	--	V	60
Ford Ranger III inc. towball for vehicles with integrated step in the bumper	03/12-11/22			307 613 600 001		30	30.6	16.4	225	3500		307 556 300 113	03/16-11/22		S	CAN	C1	E2	D1	L1	V	90
												343 069 300 113	-02/16		S	CAN	C	E	D	--	V	60
Ford Ranger III inc. towball for vehicles with bumper with integrated step	03/16-11/22	KIT		307 556 900 113		30	35.6	16.4	225	3500		included in the KIT 307 556 300 113	03/16-11/22		S	CAN	C1	E2	D1	L1	V	90

Ford

















Ford









Ford S-Max without height control with styling package by Ford Individual + for S-Max Titanium S = visible cutout	05/06-09/15		307 304 600 001		90	17.7	12.1	90	2000	307 400 300 113			S	C	E	D	L1	45		
			307 305 600 001		90	19.5	12.1	90	2000											
	KIT		307 304 900 113		90	19.7	11.1	90	2000	included in the KIT 307 400 300 113	S	C	E	D	L1	45				
	KIT		307 305 900 113		90	21.5	11.1	90	2000	included in the KIT 307 400 300 113	S	C	E	D	L1	45				
Ford S-Max II CJ without height control exc. vehicles with tailgate that opens by sensor (foot sensor) inc. Plugin-Hybrid	09/15-04/23		307 496 600 001		90	20.0	12.1	90	2000	307 499 300 113		-04/23	S	A	C1	E2	D1	L1	H	60
		KIT		307 496 900 113		90	24.0	12.1	90	2000	included in the KIT 307 499 300 113		-04/23	S	A	C1	E2	D1	L1	H
Ford S-Max II CJ without height control Please order separately cover for bumper cutout at Ford dealer's. exc. vehicles with tailgate that opens by sensor (foot sensor) inc. Plugin-Hybrid	09/15-04/23		307 497 600 001		90	20.0	12.1	90	2000	307 499 300 113		-04/23	S	A	C1	E2	D1	L1	H	60
		KIT		307 497 900 113		90	27.0	12.1	90	2000	included in the KIT 307 499 300 113		-04/23	S	A	C1	E2	D1	L1	H
Ford S-Max II CJ with height control Please order separately cover for bumper cutout at Ford dealer's. exc. vehicles with tailgate that opens by sensor (foot sensor) inc. Plugin-Hybrid	09/15-04/23		307 498 600 001		90	20.0	12.1	90	2000	307 499 300 113		-04/23	S	A	C1	E2	D1	L1	H	60
Ford Tourneo Connect II with preliminary setup exc. Active	02/14-08/18	KIT		307 500 900 113		90	16.6	8.3	75	1250	included in the KIT 307 500 300 113	-08/18 for vehicles with preparation	S	CAN		E	D	L1	H	60
		KIT		307 501 900 113		90	16.6	8.3	75	1250	included in the KIT 307 500 300 113	-08/18 for vehicles with preparation	S	CAN		E	D	L1	H	60
Ford Tourneo Connect II exc. Active	02/14-01/22		307 500 600 001		90	15.5	8.3	75	1250	307 500 300 113	-08/18 for vehicles with preparation	S	CAN		E	D	L1	H	60	
			307 501 600 001		90	15.5	8.3	75	1250	307 576 300 113	09/18- WLC 2.0	inc.	S	A	C1	E	D1	--	V	90

Ford Tourneo Connect II exc. Active	09/18-01/22	KIT		307 576 900 113		90	16.6	8.3	75	1250	included in the KIT 307 576 300 113	09/18- WLC 2.0	inc.	S	A	C1	E	D1	--	V	90
		KIT		307 577 900 113		90	16.6	8.3	75	1250	included in the KIT 307 576 300 113	09/18- WLC 2.0	inc.	S	A	C1	E	D1	--	V	90
Ford Tourneo Connect III	02/22-			322 088 600 001		90	20.0	9.8	119	1620	322 088 300 113	02/22- with preliminary setup	S	CAN	C	E	D	L	H	30	
				322 089 600 001		90	23.0	9.8	119	1620	322 089 300 113	02/22- without preliminary setup	S	CAN	C	E	D	L	V	60	
											322 092 300 113	02/22- without preliminary setup, 09/20- without preliminary setup, inc. WLC 2.0	S	CAN	C	E	D	L	V	90	
Ford Tourneo Connect III for vehicles without preliminary setup	02/22-	KIT		322 088 900 113		90	22.0	9.8	119	1620	included in the KIT 322 092 300 113	02/22- without preliminary setup, 09/20- without preliminary setup, inc. WLC 2.0	S	CAN	C	E	D	L	V	90	
		KIT		322 089 900 113		90	25.0	9.8	119	1620	included in the KIT 322 092 300 113	02/22- without preliminary setup, 09/20- without preliminary setup, inc. WLC 2.0	S	CAN	C	E	D	L	V	90	
Ford Tourneo Connect III for vehicles with preliminary setup	02/22-	KIT		322 086 900 113		90	21.5	9.8	119	1620	included in the KIT 322 088 300 113	02/22- with preliminary setup	S	CAN	C	E	D	L	H	30	
		KIT		322 087 900 113		90	24.5	9.8	119	1620	included in the KIT 322 088 300 113	02/22- with preliminary setup	S	CAN	C	E	D	L	H	30	
Ford Tourneo Courier exc. AdBlue	02/14-10/23			307 638 600 001		45	18.9	5.9	50	910	307 573 300 113	-10/23	S	A	C1	E1	D1	--	H	75	
				307 639 600 001		45	20.3	5.9	50	910											
		KIT		307 638 900 113		45	20.6	5.9	50	910	included in the KIT 307 573 300 113	-10/23	S	A	C1	E1	D1	--	H	75	
		KIT		307 639 900 113		45	22.0	5.9	50	910	included in the KIT 307 573 300 113	-10/23	S	A	C1	E1	D1	--	H	75	

Ford

Ford





























Ford Tourneo Custom Van V362	11/12-			307 382 600 001		30	17.2	14.9	120	2800		307 386 300 113	-05/16	S	CAN	C	E	D	L1	V	90				
												307 624 300 113	06/16-	S	C2	C1	E2	D	L1	V	60				
Ford Tourneo Custom Van	11/12-			307 385 600 001		30	23.0	14.9	120	2800		307 386 300 113	-05/16	S	CAN	C	E	D	L1	V	90				
Ford Tourneo Custom Van V362 inc. towball	11/12-05/16	KIT		307 382 900 113		30	19.0	14.9	120	2800		included in the KIT 307 386 300 113	-05/16	S	CAN	C	E	D	L1	V	90				
Ford Tourneo Custom Van V362	11/12-05/16	KIT		307 385 900 113		30	25.0	14.9	120	2800		included in the KIT 307 386 300 113	-05/16	S	CAN	C	E	D	L1	V	90				
Ford Transit Connect II with preliminary setup exc. Active	02/14-08/18	KIT		307 500 900 113		90	16.6	8.3	75	1250		included in the KIT 307 500 300 113	-08/18 for vehicles with preparation	S	CAN		E	D	L1	H	60				
						KIT		307 501 900 113		90	16.6	8.3	75	1250		included in the KIT 307 500 300 113	-08/18 for vehicles with preparation	S	CAN		E	D	L1	H	60
Ford Transit Connect II exc. Active	02/14-01/22			307 500 600 001		90	15.5	8.3	75	1250		307 500 300 113	-08/18 for vehicles with preparation	S	CAN		E	D	L1	H	60				
							307 501 600 001		90	15.5	8.3	75	1250		307 576 300 113	09/18-WLC 2.0 inc.	S	A	C1	E	D1	--	V	90	
Ford Transit Connect II exc. Active	09/18-01/22	KIT		307 576 900 113		90	16.6	8.3	75	1250		included in the KIT 307 576 300 113	09/18-WLC 2.0 inc.	S	A	C1	E	D1	--	V	90				
						KIT		307 577 900 113		90	16.6	8.3	75	1250		included in the KIT 307 576 300 113	09/18-WLC 2.0 inc.	S	A	C1	E	D1	--	V	90
Ford Transit Courier B460 exc. AdBlue	02/14-10/23			307 638 600 001		45	18.9	5.9	50	910		307 573 300 113	-10/23	S	A	C1	E1	D1	--	H	75				
							307 639 600 001		45	20.3	5.9											50	910		
						KIT		307 638 900 113		45	20.6	5.9	50	910		included in the KIT 307 573 300 113	-10/23	S	A	C1	E1	D1	--	H	75
						KIT		307 639 900 113		45	22.0	5.9	50	910		included in the KIT 307 573 300 113	-10/23	S	A	C1	E1	D1	--	H	75

Ford Transit Custom Van V362	11/12-		307 382 600 001	30	17.2	14.9	120	2800	307 386 300 113	05/16-06/19	S	CAN	C	E	D	L1	V	90	
									307 575 300 113		S	A	C1	E2	D	L1	V	75	
									307 624 300 113		S	C2	C1	E2	D	L1	V	60	
Ford Transit Custom Van	11/12-		307 385 600 001	30	23.0	14.9	120	2800	307 386 300 113	05/16-06/19	S	CAN	C	E	D	L1	V	90	
									307 575 300 113		S	A	C1	E2	D	L1	V	75	
									307 624 300 113		S	C2	C1	E2	D	L1	V	60	
Ford Transit Custom Van inc. towball	11/12-04/16	KIT		307 382 900 113	30	19.0	14.9	120	2800	included in the KIT 307 386 300 113		S	CAN	C	E	D	L1	V	90
Ford Transit Custom Van	11/12-04/16	KIT		307 385 900 113	30	25.0	14.9	120	2800	included in the KIT 307 386 300 113		S	CAN	C	E	D	L1	V	90
Ford Transit Van name of the type begins with "F" inc. towball exc. vehicles with step suitable step: 313440600001 For vehicles from 08/2004 please order separately at Ford dealers: reinforcement for longitudinal beam 1 x FINIS 4583024, nut 2	04/00-12/12	KIT		307 260 900 113	60	18.2	15.3	112	2800	included in the KIT 307 260 300 113		S	FRE	--	--	D1	--	V	75
Ford Transit Van name of the type begins with "F", towing bracket inc. towball exc. vehicles with step suitable step: 313440600001 For vehicles from 08/2004 please order separately at Ford dealers: reinforcement for longitudinal beam 1 x FINIS 4583024, nut 2 x FINIS 4105891, screw 2 x FINIS 4046120	04/00-12/12			307 611 600 001	60	16.3	15.3	112	2800	307 260 300 113		S	FRE	--	--	D1	--	V	75
Ford Transit Van 4,6 t max. total weight Only available at Ford dealers.	10/07-																		
Ford Transit Van V363 inc. towball inc. E-Transit	05/14-		307 630 600 001	40	34.7	17.2	140	3500	307 386 300 113	-04/16	S	CAN	C	E	D	L1	V	90	
									307 575 300 113	05/16-	S	A	C1	E2	D	L1	V	75	
									307 624 300 113	06/16-	S	C2	C1	E2	D	L1	V	60	
Ford Transit Van V363 inc. towball inc. E-Transit	05/16-	KIT		307 630 900 113	40	39.7	17.2	140	3500	included in the KIT 307 575 300 113	05/16-	S	A	C1	E2	D	L1	V	75

Ford





Ford

Ford Transit Chassis Cab 4,6 t max. total weight Only available at Ford dealers.	10/07-																			
---	--------	--	--	--	--	--	--	--	--	--	--	--	--	--	--	--	--	--	--	--

Honda Accord Saloon (CU) exc. type S	01/08-12/15		338 066 600 001		90	21.0	9.5	75	1700	300 072 300 107	--	FRE	--	--	--	--	V		
											300 072 300 113	--	FRE	--	--	D1	L1	V	
Honda Accord Tourer (CW)	01/08-12/15		338 066 600 001		90	21.0	9.5	75	1700	300 072 300 107	--	FRE	--	--	--	--	V		
											300 072 300 113	--	FRE	--	--	D1	L1	V	
Honda CRV IV (RM) exc. AdBlue	11/12-09/18		338 107 600 001		90	19.0	10.7	100	2000	300 210 300 113	--	A	--	E1	D1	L1	V	90	
			338 108 600 001			90	20.0	10.7	100		2000								
Honda CRV V (RW) inc. Hybrid exc. vehicles with tailgate that opens by sensor (foot sensor)	10/18-08/23		338 130 600 001		60	25.5	10.6	120	2000										
			338 131 600 001			60	28.2	10.6	120	2000									
Honda Civic IX Tourer	02/14-02/18		338 120 600 001		75	26.0	8.2	75	1400	300 210 300 113	--	A	--	E1	D1	L1	V	90	
Honda Civic VIII 3/5 doors exc. Civic "R"	01/06-09/11		338 091 600 001		60	22.0	8.3	75	1500	300 072 300 107	--	FRE	--	--	--	--	V		
											300 072 300 113	--	FRE	--	--	D1	L1	V	
Honda Civic X Hatchback exc. type R exc. Sport Plus	02/17-07/22		338 127 600 001		60	21.7	8.5	103	1550										
			338 128 600 001			60	24.7	8.5	103	1550									
Honda HRV II	09/15-09/21		338 109 600 001		120	21.2	8.1	60	1400	338 110 300 113	S	A		E2	D	L1	V	90	
			338 110 600 001			120	22.3	8.1	60		1400								
		KIT		338 109 900 113		120	25.0	8.1	60	1400	included in the KIT 338 110 300 113	S	A		E2	D	L1	V	90
		KIT		338 110 900 113		120	27.0	8.1	60	1400	included in the KIT 338 110 300 113	S	A		E2	D	L1	V	90





























Honda

Honda





















<p>Honda Jazz IV GK</p>	<p>09/15-01/20</p>		<p>338 125 600 001</p>			<p>60</p>	<p>20.0</p>	<p>6.2</p>	<p>76</p>	<p>1000</p>		<p>300 210 300 113</p>			<p>--</p>	<p>A</p>	<p>--</p>	<p>E1</p>	<p>D1</p>	<p>L1</p>	<p>V</p>	<p>90</p>	
			<p>338 126 600 001</p>			<p>60</p>	<p>22.0</p>	<p>6.2</p>	<p>76</p>	<p>1000</p>													

Hyundai



Hyundai i 30 Hatchback exc. 2.0 N exc. AdBlue exc. N-Line	01/17-08/18		346 124 600 001		60	21.8	8.3	80	1500		346 143 300 113			S	A	--	E2	D1	L1	V	90	
		KIT		346 112 900 113		60	28.0	8.3	80	1500		included in the KIT 346 143 300 113			S	A	--	E2	D1	L1	V	90
Hyundai i 30 Hatchback exc. 2.0 N exc. AdBlue exc. vehicles with park distance control exc. N-Line	01/17-08/18		346 123 600 001		60	21.8	8.3	80	1500		346 143 300 113			S	A	--	E2	D1	L1	V	90	
		KIT		346 111 900 113		60	26.8	8.3	80	1500		included in the KIT 346 143 300 113			S	A	--	E2	D1	L1	V	90
Hyundai i 30 Hatchback inc. AdBlue inc. N-Line -06/20	09/18-		346 155 600 001		75	19.8	8.7	106	1620		346 143 300 113			S	A	--	E2	D1	L1	V	90	
			346 156 600 001		75	22.5	8.7	106	1620						S	A	--	E2	D1	L1	V	90
		KIT		346 155 900 113		75	21.4	8.7	106	1620		included in the KIT 346 143 300 113			S	A	--	E2	D1	L1	V	90
		KIT		346 156 900 113		75	24.1	8.7	106	1620		included in the KIT 346 143 300 113			S	A	--	E2	D1	L1	V	90
Hyundai i 30 Stationwagon exc. 2.0 N exc. AdBlue	07/17-07/20		346 124 600 001		60	21.8	8.3	80	1500		346 145 300 113			S	A	C1	E2	D1	L1	V	90	
		KIT		346 124 900 113		60	23.8	8.3	80	1500		included in the KIT 346 145 300 113			S	A	C1	E2	D1	L1	V	90
Hyundai i 30 Stationwagon exc. vehicles with park distance control exc. 2.0 N exc. AdBlue	07/17-07/20		346 123 600 001		60	21.8	8.3	80	1500		346 145 300 113			S	A	C1	E2	D1	L1	V	90	
		KIT		346 123 900 113		60	22.6	8.3	80	1500		included in the KIT 346 145 300 113			S	A	C1	E2	D1	L1	V	90



Hyundai I 30 cw Stationwagon	06/12-06/17			345 111 600 001		60	19.0	8.5	75	1500	346 071 300 113			S	A	--	E1	D1	--	V	75
				345 112 600 001		60	24.5	8.5	75	1500											
		KIT		346 073 900 113		90	22.0	8.5	75	1500	included in the KIT 346 071 300 113			S	A	--	E1	D1	--	V	75
		KIT		346 074 900 113		90	25.0	8.5	75	1500	included in the KIT 346 071 300 113			S	A	--	E1	D1	--	V	75
Hyundai IX 20	11/10-07/19			346 063 600 001		90	20.0	7.6	75	1300	346 064 300 113			S	A	--	E1	D1	--	V	75
				346 064 600 001		90	21.0	7.6	75	1300											
		KIT		346 063 900 113		90	22.0	7.6	75	1300	included in the KIT 346 064 300 113			S	A	--	E1	D1	--	V	75
		KIT		346 064 900 113		90	23.0	7.6	75	1300	included in the KIT 346 064 300 113			S	A	--	E1	D1	--	V	75
Hyundai IX 35	03/10-09/15			346 048 600 001		90	23.0	11.1	96	2400	346 049 300 113			S	A	--	E2	D1	L1	V	90
				346 049 600 001		90	28.7	11.1	96	2400											
		KIT		346 048 900 113		90	25.0	11.1	96	2400	included in the KIT 346 049 300 113			S	A	--	E2	D1	L1	V	90
		KIT		346 049 900 113		90	30.5	11.1	96	2400	included in the KIT 346 049 300 113			S	A	--	E2	D1	L1	V	90
Hyundai Ioniq 5 NE	05/21-			346 175 600 001		90	19.0	10.0	122	1650	345 150 300 113		05/21- with preliminary setup	S	A	--	E2	D	L	H	75
Hyundai Ioniq 5 NE with preliminary setup	05/21-	KIT		346 175 900 113		90		10.0	122	1650	included in the KIT 345 150 300 113		05/21- with preliminary setup	S	A	--	E2	D	L	H	75























Hyundai

Hyundai Tucson	07/15-06/18			346 103 600 001			60	25.0	11.3	100	2200		346 049 300 113	-06/18	S	A	--	E2	D1	L1	V	90
				346 104 600 001		60	27.0	11.3	100	2200												
	KIT		346 103 900 113		60	29.0	11.3	100	2200	included in the KIT 346 049 300 113	-06/18	S	A	--	E2	D1	L1	V	90			
	KIT		346 104 900 113		60	30.0	11.3	100	2200	included in the KIT 346 049 300 113	-06/18	S	A	--	E2	D1	L1	V	90			
Hyundai Tucson TL, TLE inc. N-Line	07/18-11/20			345 140 600 001			75	26.1	10.9	133	2200		346 149 300 113	-11/20	S	A	C1	E2	D1	L1	V	90
				345 141 600 001		75	27.6	10.9	133	2200												
	KIT		345 140 900 113		75	27.2	10.9	133	2200	included in the KIT 346 149 300 113	-11/20	S	A	C1	E2	D1	L1	V	90			
	KIT		345 141 900 113		75	28.7	10.9	133	2200	included in the KIT 346 149 300 113	-11/20	S	A	C1	E2	D1	L1	V	90			
Hyundai Tucson IV NX4E	11/20-			346 165 600 001			60	20.0	11.5	140	2200		345 150 300 113	11/20- with preliminary setup	S	A	--	E2	D	L	H	75
				346 166 600 001		60	22.0	11.5	140	2200												
Hyundai Tucson IV NX4E with preliminary setup	11/20-	KIT		346 165 900 113			60	21.0	11.5	140	2200	included in the KIT 345 150 300 113	11/20- with preliminary setup	S	A	--	E2	D	L	H	75	
		KIT		346 166 900 113			60	24.0	11.5	140	2200	included in the KIT 345 150 300 113	11/20- with preliminary setup	S	A	--	E2	D	L	H	75	
		KIT		346 171 900 113		90	33.0	11.5	140	2200	included in the KIT 346 001 300 153	not available individually	S	CAN	--	E2	D	L	H	75		

Isuzu

























Isuzu D-Max 4x4 exc. 4x2 exc. vehicles with double tube exhaust system inc. towball	06/12-12/20			342 195 600 001			90	29.0	16.1	140	3500												
Isuzu D-Max III TF exc. vehicles with underrun guard	01/21-			342 304 600 001		60	29.7	16.4	245	3500		342 315 300 113		01/21-	S	FRE	--	E	D	L	H	15	
		KIT		342 304 900 113	→	60	30.9	16.4	245	3500		included in the KIT 342 315 300 113		01/21-	S	FRE	--	E	D	L	H	15	

Iveco-Daily VI Van 33 - 50 inc. towball with preliminary setup only for vehicles with a single- layer frame	03/14-			342 284 600 001			45	35.1	21.1	140	3500		342 239 300 113		with preliminary setup	S	FRE	--	--	D	L	H	45	
Iveco-Daily VI Iveco-Daily VI 33 - 50 inc. towball with preliminary setup only for vehicles with a single- layer frame	03/14-			342 284 600 001			45	35.1	21.1	140	3500		342 239 300 113		with preliminary setup	S	FRE	--	--	D	L	H	45	

Jeep Avenger	03/23-			304 216 600 001		90	25.0	7.1	61	1200													
Jeep Cherokee	03/08-03/14			342 131 600 001		90	30.0	15.3	140	3500		300 210 300 113			--	A	--	E1	D1	L1	V	90	
Jeep Cherokee Onroad / KL	04/14-09/18			342 207 600 001		60	33.0	12.4	150	2500		306 528 300 113		10/18-	S	A	C1	E2	D	L1	V	150	
												342 200 300 113		-09/18	S	A		E2	D	L1	V	150	
Jeep Compass (MP) inc. AdBlue inc. Hybrid (4xe) exc. Trailhawk exc. vehicles with tailgate that opens by sensor (foot sensor)	12/16-			342 301 600 001		60	23.3	10.2	95	1900		342 265 300 113			S	CAN	--	E	D	L1	V	75	
				342 302 600 001		60	26.3	10.2	95	1900					S	CAN	--	E	D	L1	V	75	
		KIT		342 301 900 113		60	26.5	10.2	95	1900		included in the KIT 342 265 300 113			S	CAN	--	E	D	L1	V	75	
		KIT		342 302 900 113		60	28.4	10.2	95	1900		included in the KIT 342 265 300 113			S	CAN	--	E	D	L1	V	75	
Jeep Grand Cherokee exc. SRT8 inc. Summit exc. Trackhawk	04/11-06/13	KIT		342 185 900 113		90	23.0	16.0	175	3500		included in the KIT 342 184 300 113		-06/13	S	A	C	--	D	L1	V	120	
Jeep Grand Cherokee WK2 inc. Facelift 06/13- exc. SRT8/Summit/Trackhawk	04/11-04/21			342 184 600 001		90	21.0	16.0	175	3500		342 184 300 113		-06/13	S	A	C	--	D	L1	V	120	
												342 190 300 113		06/13-	S	A	--	E1	D	L1	V	120	
Jeep Grand Cherokee WK2 exc. SRT8 inc. Summit exc. Trackhawk	04/11-04/21			342 221 600 001		90	23.0	16.0	175	3500		342 184 300 113		-06/13	S	A	C	--	D	L1	V	120	
												342 190 300 113		06/13-	S	A	--	E1	D	L1	V	120	
Jeep Grand Cherokee WK2 exc. SRT8 inc. Summit exc. Trackhawk	06/13-04/21	KIT		342 190 900 113		90	23.0	16.0	175	3500		included in the KIT 342 190 300 113		06/13-	S	A	--	E1	D	L1	V	120	





























Jeep

























Jeep Renegade inc. AdBlue inc. Hybrid (4xe) inc. Cross exc. Sport exc. Trailhawk	07/14-			342 301 600 001		60	23.3	10.2	95	1900		342 300 300 113	07/14-	--	FRE	--	E	D1	L1	V	150
				342 302 600 001		60	26.3	10.2	95	1900											
		KIT		342 299 900 113		60	25.2	10.2	95	1900		included in the KIT 342 300 300 113	07/14-	--	FRE	--	E	D1	L1	V	150
		KIT		342 300 900 113		60	28.2	10.2	95	1900		included in the KIT 342 300 300 113	07/14-	--	FRE	--	E	D1	L1	V	150
Jeep Wrangler III (JK) AdBlue models -10/17 inc. towball	04/07-10/17			342 104 600 001		60	12.0	15.0	170	3500		342 105 300 113		S	A	--	E2	D	L1	V	150
Jeep Wrangler III (JK) AdBlue models -10/17	04/07-10/17			306 535 600 001		30	12.0	15.1	140	3500		342 105 300 113		S	A	--	E2	D	L1	V	150
		KIT		306 535 900 113		30	13.6	15.1	140	3500		included in the KIT 342 105 300 113		S	A	--	E2	D	L1	V	150
Jeep Wrangler IV (JL) inc. 4xe Plugin Hybrid	11/17-			306 535 600 001		30	12.0	15.1	140	3500		342 105 300 113		S	A	--	E2	D	L1	V	150
		KIT		306 535 900 113		30	13.6	15.1	140	3500		included in the KIT 342 105 300 113		S	A	--	E2	D	L1	V	150

Kia Carens inc. facelift 08/16-	03/12-12/18			345 091 600 001		90	20.0	9.1	75	1500		300 210 300 113			--	A	--	E1	D1	L1	V	90
				345 092 600 001		90	22.0	9.1	75	1500												
Kia Cee'd 5 doors	06/12-03/18			345 086 600 001		60	20.0	8.3	75	1500		345 086 300 113	-03/18	S	A	--	E2	D1	L1	V	90	
			KIT		345 086 900 113		60	22.0	8.3	75	1500		included in the KIT 345 086 300 113	-03/18	S	A	--	E2	D1	L1	V	90
Kia Cee'd 5 doors GT-Line	09/16-03/18			345 115 600 001		60	22.5	8.3	60	1500		345 086 300 113	-03/18	S	A	--	E2	D1	L1	V	90	
			KIT		345 115 900 113		60	24.7	8.3	60	1500		included in the KIT 345 086 300 113	-03/18	S	A	--	E2	D1	L1	V	90
Kia Cee'd Sporty Wagon	07/07-09/12			345 059 600 001	→ 	90	17.5	8.6	75	1500		345 059 300 113	→ 09/09-	S	A	--	--	D1	L1	V	75	
Kia Cee'd Sporty Wagon	09/09-09/12	KIT		345 059 900 113	→ 	90	19.5	8.6	75	1500		included in the KIT 345 059 300 113	→ 09/09-	S	A	--	--	D1	L1	V	75	
Kia Cee'd sw/Sportswagon inc. GT Line	10/12-03/18	KIT		345 088 900 113		90	22.0	8.5	75	1500		included in the KIT 345 086 300 113	-03/18	S	A	--	E2	D1	L1	V	90	
Kia Cee'd sw/Sportswagon inc. GT Line	10/12-03/18			345 111 600 001		60	19.0	8.5	75	1500		345 086 300 113	-03/18	S	A	--	E2	D1	L1	V	90	
				345 112 600 001		60	24.5	8.5	75	1500												
			KIT		345 089 900 113		60	24.5	8.5	75	1500		included in the KIT 345 086 300 113	-03/18	S	A	--	E2	D1	L1	V	90

Kia



























Kia





















Kia Ceed	03/18-		345 146 600 001		45	19.8	8.4	100	1500	345 134 300 113	03/18- 2.0	inc. WLC	S	A	C1	E2	D1	L1	V	60
			345 147 600 001		45	22.5	8.4	100	1500											
	KIT		345 146 900 113		45	20.2	8.4	100	1500	included in the KIT 345 134 300 113	03/18- 2.0	inc. WLC	S	A	C1	E2	D1	L1	V	60
	KIT		345 147 900 113		45	22.9	8.4	100	1500	included in the KIT 345 134 300 113	03/18- 2.0	inc. WLC	S	A	C1	E2	D1	L1	V	60
Kia Ceed Sportswagon exc. vehicles with park distance control exc. GT-Line	04/18-		345 144 600 001		45	20.3	8.4	100	1500	345 134 300 113	04/18- 2.0	inc. WLC	S	A	C1	E2	D1	L1	V	60
		KIT		345 144 900 113		45	21.8	8.4	100	1500	included in the KIT 345 134 300 113	04/18- 2.0	inc. WLC	S	A	C1	E2	D1	L1	V
Kia Ceed Sportswagon exc. GT-Line	04/18-		345 145 600 001		45	23.0	8.4	100	1500	345 134 300 113	04/18- 2.0	inc. WLC	S	A	C1	E2	D1	L1	V	60
		KIT		345 145 900 113		45	24.5	8.4	100	1500	included in the KIT 345 134 300 113	04/18- 2.0	inc. WLC	S	A	C1	E2	D1	L1	V
Kia EV6 CV	07/21-		345 180 600 001		60	24.2	10.6	129	1800	345 150 300 113	07/21- with preliminary setup	S	A	--	E2	D	L	H	75	
			345 181 600 001		60		10.6	129	1800											
		KIT		345 180 900 113		60		10.6	129	1800	included in the KIT 345 150 300 113	07/21- with preliminary setup	S	A	--	E2	D	L	H	75
Kia EV6 CV with preliminary setup	07/21-	KIT		345 181 900 113		60		10.6	129	1800	included in the KIT 345 150 300 113	07/21- with preliminary setup	S	A	--	E2	D	L	H	75
Kia Niro I DE exc. e-Niro	01/17-08/22		345 116 600 001		90	23.3	7.6	100	1300	345 173 300 113	10/17- with preliminary setup	S	A	--	E2	D1	L1	H	75	
			345 117 600 001		90	20.8	7.6	100	1300											

Kia Niro I DE with preliminary setup exc. e-Niro	10/17-08/22	KIT		345 173 900 113		60	21.8	7.6	100	1300		included in the KIT 345 173 300 113	10/17- with preliminary setup	S	A	--	E2	D1	L1	H	75	
		KIT		345 174 900 113		60	24.1	7.6	100	1300		included in the KIT 345 173 300 113	10/17- with preliminary setup	S	A	--	E2	D1	L1	H	75	
Kia Optima Hatchback exc. Hybrid exc. AdBlue	01/16-09/19			345 113 600 001		60	19.0	9.7	80	1800												
Kia Optima Sportswagon exc. Hybrid exc. AdBlue	10/16-09/19			345 113 600 001		60	19.0	9.7	80	1800		345 168 300 113		S	A	C1	E2	D	L1	H	60	
		KIT		345 168 900 113		60	20.0	9.7	80	1800		included in the KIT 345 168 300 113		S	A	C1	E2	D	L1	H	60	
Kia ProCee'd exc. Pro Cee'd GT	03/13-09/18			345 086 600 001		60	20.0	8.3	75	1500		345 086 300 113	-03/18	S	A	--	E2	D1	L1	V	90	
Kia ProCeed CD	10/18-			345 151 600 001		60	20.9	8.5	104	1500		345 134 300 113	10/18- inc. WLC 2.0	S	A	C1	E2	D1	L1	V	60	
				345 152 600 001		60	23.9	8.5	104	1500												
		KIT		345 151 900 113		60	22.4	8.5	104	1500		included in the KIT 345 134 300 113	10/18- inc. WLC 2.0	S	A	C1	E2	D1	L1	V	60	
		KIT		345 152 900 113		60	25.4	8.5	104	1500		included in the KIT 345 134 300 113	10/18- inc. WLC 2.0	S	A	C1	E2	D1	L1	V	60	
Kia Rio Hatchback IV YB inc. facelift	01/17-			345 127 600 001		75	19.7	6.6	75	1110		345 171 300 113		S	A	--	E1	D1	--	V	90	
		KIT		345 127 900 113		75	20.7	6.6	75	1110		included in the KIT 345 171 300 113		S	A	--	E1	D1	--	V	90	
Kia Sorento III inc. AdBlue	01/15-03/20			345 142 600 001		60	27.2	12.6	135	2500		345 143 300 113		S	A	--	E2	D	L1	V	90	
				345 143 600 001		60	29.9	12.6	135	2500												

Kia

Kia

Kia Sorento IV MQ4 inc. Hybrid	03/20-			345 167 600 001		90	20.0	13.0	159	2550	345 150 300 113	03/20- with preliminary setup	S	A	--	E2	D	L	H	75
				345 168 600 001		90	22.0	13.0	159	2550										
Kia Sorento IV MQ4 with preliminary setup inc. Hybrid	03/20-	KIT		345 165 900 113		90	21.0	13.0	159	2550	included in the KIT 345 150 300 113	03/20- with preliminary setup	S	A	--	E2	D	L	H	75
				345 166 900 113		90	23.0	13.0	159	2550	included in the KIT 345 150 300 113	03/20- with preliminary setup	S	A	--	E2	D	L	H	75
Kia Soul and Soul II PS exc. Soul EV exc. Soul Dream Team Edition	04/14-04/19			345 128 600 001		60	21.0	7.6	80	1300										
				345 129 600 001		60	21.0	7.6	80	1300										
Kia Sportage SL	08/10-02/16			345 087 600 001		90	23.0	11.0	80	2400	345 079 300 113		S	A	--	E2	D1	L1	V	90
				345 079 600 001		60	25.0	10.6	80	2300										
		KIT		345 087 900 113		90	25.0	11.0	80	2400	included in the KIT 345 079 300 113		S	A	--	E2	D1	L1	V	90
				345 079 900 113		60	27.0	10.6	80	2300	included in the KIT 345 079 300 113		S	A	--	E2	D1	L1	V	90
Kia Sportage	02/16-05/18			346 103 600 001		60	25.0	11.3	100	2200	345 155 300 113	-05/18	S	A	--	E2	D	L1	V	60
				346 104 600 001		60	27.0	11.3	100	2200										
		KIT		345 103 900 113		60	29.0	11.3	100	2200	included in the KIT 345 155 300 113	-05/18	S	A	--	E2	D	L1	V	60
				345 104 900 113		60	31.0	11.3	100	2200	included in the KIT 345 155 300 113	-05/18	S	A	--	E2	D	L1	V	60





















Kia Sportage IV QLE	06/18-09/21			345 140 600 001			75	26.1	10.9	133	2200		345 174 300 113	inc. WLC 2.0	S	A	C1	E2	D1	L1	V	60
				345 141 600 001			75	27.6	10.9	133	2200											
Kia Sportage V NQ5	09/21-			345 171 600 001			60	19.7	10.8	132	2000		345 150 300 113	09/21- with preliminary setup	S	A	--	E2	D	L	H	75
				345 172 600 001			60	21.5	10.8	132	2000											
Kia Sportage V NQ5 with preliminary setup	09/21-	KIT		345 171 900 113			60	21.6	10.8	132	2000	included in the KIT 345 150 300 113	09/21- with preliminary setup	S	A	--	E2	D	L	H	75	
				345 172 900 113			60	23.4	10.8	132	2000	included in the KIT 345 150 300 113										09/21- with preliminary setup
Kia Stonic I YB	07/17-			345 138 600 001			90	22.2	6.9	75	1110		345 172 300 113			A	--	E2	D1	L1	V	120
				345 139 600 001			90	21.6	6.9	75	1110											
		KIT		345 139 900 113			90	22.6	6.9	75	1110	included in the KIT 345 172 300 113				A	--	E2	D1	L1	V	120
Kia Venga I YN	03/10-09/19			345 069 600 001			90	20.0	7.6	75	1300		346 064 300 113	-09/19	S	A	--	E1	D1	--	V	75
				345 070 600 001			90	21.0	7.6	75	1300											

Kia

Kia XCeed (CD) inc. Hybrid	06/19-			345 155 600 001		40	23.5	8.5	104	1540		345 134 300 113	06/19- 2.0	inc. WLC	S	A	C1	E2	D1	L1	V	60
				345 156 600 001		40	27.0	8.5	104	1540												
		KIT		345 155 900 113		40	25.2	8.5	104	1540		included in the KIT 345 134 300 113	06/19- 2.0	inc. WLC	S	A	C1	E2	D1	L1	V	60
		KIT		345 156 900 113		40	28.8	8.5	104	1540		included in the KIT 345 134 300 113	06/19- 2.0	inc. WLC	S	A	C1	E2	D1	L1	V	60









Land Rover







Land Rover Discovery Please order the original spoiler from the vehicle dealer.	05/17-			323 157 600 001		60	40.4	16.3	195	3500		323 107 300 113			S	C2	C	E2	D	L	H	15
		KIT		323 157 900 113		60	42.5	16.3	195	3500		included in the KIT 323 107 300 113			S	C2	C	E2	D	L	H	15
Land Rover Discovery Sport L550 7 seats for vehicles with hollow for spare wheel	09/14-04/19			323 181 600 001		60	34.0	11.8	135	2200		323 141 300 113			S	C2	C	E	D	L	H	45
Land Rover Discovery Sport L550 7 seats for vehicles without hollow for spare wheel	02/15-			323 141 600 001		90	28.0	12.5	150	2500		323 141 300 113			S	C2	C	E	D	L	H	45
		KIT		323 141 900 113		90	32.0	12.5	150	2500		included in the KIT 323 141 300 113			S	C2	C	E	D	L	H	45
Land Rover Discovery Sport for vehicles with hollow for spare wheel	05/19-			323 192 600 001		90	39.3	11.3	145	2000		323 189 300 113	05/19-12/20		S	C2	C1	E2	D	L	H	45
												323 191 300 113	01/21-		S	C2	C1	E2	D	L	H	45
Land Rover Freelander 2 inc. facelift 2013-	05/07-10/14			323 079 600 001		105	20.0	11.0	150	2000		323 411 300 113	→ 10/12-		S	C2	--	E1	D	L	H	30
Range-Rover Evoque L538	09/11-12/18			323 101 600 001		90	18.0	10.6	150	2000		323 102 300 113			S	C2	--	E	D	L	H	30
				323 102 600 001		90	20.0	10.6	150	2000						S	C2	--	E	D	L	H
		KIT		323 101 900 113		90	20.0	10.6	150	2000		included in the KIT 323 102 300 113			S	C2	--	E	D	L	H	30
		KIT		323 102 900 113		90	22.0	10.6	150	2000		included in the KIT 323 102 300 113			S	C2	--	E	D	L	H	30

Range-Rover Evoque Cabriolet L538	05/16-12/18			323 101 600 001		90	18.0	10.6	150	2000		323 102 300 113			S	C2	--	E	D	L	H	30
				323 102 600 001		90	20.0	10.6	150	2000												
		KIT		323 101 900 113		90	20.0	10.6	150	2000		included in the KIT 323 102 300 113			S	C2	--	E	D	L	H	30
		KIT		323 102 900 113		90	22.0	10.6	150	2000		included in the KIT 323 102 300 113			S	C2	--	E	D	L	H	30
Range-Rover Evoque II L551 inc. AdBlue	12/18-			323 189 600 001		60	30.3	11.1	130	2000		323 189 300 113	12/18-12/20	S	C2	C1	E2	D	L	H	45	
				323 190 600 001		60	33.4	11.1	130	2000		323 191 300 113	01/21-	S	C2	C1	E2	D	L	H	45	
Range-Rover IV L405	01/13-10/21			323 107 600 001		120	50.5	16.6	200	3500		323 107 300 113	01/13-10/21	S	C2	C	E2	D	L	H	15	
Range Rover L322 Mounting tube inc. detachable towball, storage bowl and fitting material (only in connection with 323064600001 or 323074600001)	02/02-12			323 062 600 001		15	11.5	16.4	150	3500		323 064 300 113	-09/09	S	FRE	--	E	D	L	H	30	
Range Rover Sport The vehicle already has a built in towball receptor. Please order additional equipment with Land Rover dealers.	03/05-10/13																					
Range Rover Sport L 494 exc. Plugin Hybrid	10/13-05/22			323 121 600 001		120	51.5	16.6	200	3500		323 107 300 113		S	C2	C	E2	D	L	H	15	
Range-Rover Velar L560 exc. V6 and V8	10/17-			323 171 600 001		60	33.5	12.5	175	2500		323 146 300 113	10/17-12/18	S	CAN	--	--	D	L	H	60	
												323 189 300 113	01/19-12/20	S	C2	C1	E2	D	L	H	45	
Range-Rover Velar L560 exc. V6 and V8	10/17-12/18	KIT		323 171 900 113		75	34.0	12.5	175	2500		included in the KIT 323 146 300 113	10/17-12/18	S	CAN	--	--	D	L	H	60	

Land Rover















Lexus

























Lexus RX 350 / 450 h exc. vehicles with height control	05/09-12/15			335 357 600 001		90	38.0	11.8	85	2100		335 357 300 113			S	FRE	--	--	D	L1	V	105
		KIT		335 357 900 113		90	40.0	11.8	85	2100		included in the KIT 335 357 300 113			S	FRE	--	--	D	L1	V	105
Lexus RX 350 / 450 h for vehicles with height control	05/09-12/15			335 358 600 001		90	38.0	11.9	85	2100		335 357 300 113			S	FRE	--	--	D	L1	V	105
		KIT		335 358 900 113		90	40.0	11.9	85	2100		included in the KIT 335 357 300 113			S	FRE	--	--	D	L1	V	105

MAN TGE Van singel wheels Please order separately ball plate: 329141600001 exc. vehicles with integrated step in the bumper exc. e TGE	02/17-		321 946 600 001			30	26.7	17.5	150	3500		321 112 300 113	with preliminary setup	S	CAN	--	E	D	L	V	15	
												321 113 300 107	without preliminary setup	S	CAN	C	E	--	--	V	60	
												321 113 300 113	without preliminary setup	S	CAN	C	E	D	L	V	60	
MAN TGE Van twin wheels Please order separately ball plate 329141600001 exc. vehicles with integrated step in the bumper exc. e TGE	02/17-		321 947 600 001			30	27.0	21.0	150	3500		321 112 300 113	with preliminary setup	S	CAN	--	E	D	L	V	15	
												321 113 300 107	without preliminary setup	S	CAN	C	E	--	--	V	60	
												321 113 300 113	without preliminary setup	S	CAN	C	E	D	L	V	60	
MAN TGE Van without preliminary setup twin wheels inc. ball plate exc. vehicles with integrated step in the bumper exc. e TGE	02/17-	KIT		321 947 900 113			30	30.0	21.0	150	3500		included in the KIT 321 113 300 113	without preliminary setup	S	CAN	C	E	D	L	V	60
MAN TGE Van without preliminary setup single wheels inc. ball plate exc. vehicles with integrated step exc. e TGE	02/17-	KIT		321 946 900 113			30	28.5	17.5	150	3500		included in the KIT 321 113 300 113	without preliminary setup	S	CAN	C	E	D	L	V	60
MAN TGE Van singel wheels inc. ball plate only vehicles with integrated step in the bumper exc. e TGE	02/17-		322 011 600 001			60	29.7	15.8	120	3000		321 112 300 113	with preliminary setup	S	CAN	--	E	D	L	V	15	
												321 113 300 107	without preliminary setup	S	CAN	C	E	--	--	V	60	
												321 113 300 113	without preliminary setup	S	CAN	C	E	D	L	V	60	
MAN TGE Chassis Cab singel wheels Please order separately ball plate: 329141600001 exc. e TGE	02/17-		321 948 600 001			30	22.0	21.0	150	3500		321 112 300 113	with preliminary setup	S	CAN	--	E	D	L	V	15	
												321 113 300 107	without preliminary setup	S	CAN	C	E	--	--	V	60	
												321 113 300 113	without preliminary setup	S	CAN	C	E	D	L	V	60	
MAN TGE Chassis Cab without preliminary setup single wheels inc. ball plate exc. e TGE	02/17-	KIT		321 948 900 113			30	26.5	21.0	150	3500		included in the KIT 321 113 300 113	without preliminary setup	S	CAN	C	E	D	L	V	60













MAN





















Mazda

Mazda CX5	04/12-04/17			343 053 600 001		90	22.0	10.8	100	2100		343 056 300 113	-04/17	S	A	--	E2	D	L1	V	90
				343 056 600 001		90	25.0	10.8	100	2100											
		KIT		343 053 900 113		90	24.0	10.8	100	2100		included in the KIT 343 056 300 113	-04/17	S	A	--	E2	D	L1	V	90
		KIT		343 056 900 113		90	27.0	10.8	100	2100		included in the KIT 343 056 300 113	-04/17	S	A	--	E2	D	L1	V	90
Mazda CX5 KF inc. AdBlue inc. facelift 2021-	05/17-			343 112 600 001		60	23.6	10.8	132	2000		343 099 300 113	05/17-	S	CAN	--	E	D1	L1	V	90
		KIT		343 112 900 113		60	25.2	10.8	132	2000		included in the KIT 343 099 300 113	05/17-	S	CAN	--	E	D1	L1	V	90
Mazda Pickup BT50 towball inc. for vehicles with integrated step in the bumper	06/12-02/16	KIT		307 613 900 113		30	35.6	16.4	225	3500		included in the KIT 343 069 300 113	-02/16	S	CAN	C	E	D	--	V	60
Mazda Pickup BT50 inc. towball for vehicles with integrated step in the bumper	06/12-12/20			307 613 600 001		30	30.6	16.4	225	3500		343 069 300 113	-02/16	S	CAN	C	E	D	--	V	60

Mercedes A Class W169	09/04-09/12			313 171 600 001		120	18.0	8.5	80	1500		313 231 300 107		without preliminary setup	S	CAN	C	E	--	--	V	90
				313 231 600 001		120	18.0	8.5	80	1500		313 231 300 113			S	CAN	C	E	D1	L1	V	90
		KIT		313 171 900 113		120	19.0	8.5	80	1500		included in the KIT 313 231 300 113			S	CAN	C	E	D1	L1	V	90
		KIT		313 231 900 113		120	19.5	8.5	80	1500		included in the KIT 313 231 300 113			S	CAN	C	E	D1	L1	V	90
Mercedes A Class W176 exc. AMG Sport Attention: Depending on the engine variation it may be necessary to change the cooling system of the vehicle.	09/12-05/18			313 396 600 001		60	23.0	9.2	80	1500		313 398 300 107			S	CAN	C	E	--	--	V	105
				313 398 600 001		60	25.0	9.2	80	1500		313 398 300 113			S	CAN	C	E	D	L	V	105
		KIT		313 396 900 113		60	25.0	9.2	80	1900		included in the KIT 313 398 300 113			S	CAN	C	E	D	L	V	105
		KIT		313 398 900 113		60	27.0	9.2	80	1500		included in the KIT 313 398 300 113			S	CAN	C	E	D	L	V	105
Mercedes A Class W177 W177 inc. AMG exc. vehicles with aerodynamic package	03/18-			313 639 600 001		60	25.3	10.7	120	2100		313 215 300 113		without preliminary setup	S	CAN	C	E	D	L	V	75
				313 640 600 001		60	26.7	10.7	120	2100												
Mercedes A Class W177 without preliminary setup inc. AMG exc. vehicles with aerodynamic package	03/18-	KIT		313 639 900 113		60	24.9	10.7	120	2100		included in the KIT 313 215 300 113		without preliminary setup	S	CAN	C	E	D	L	V	75
		KIT		313 640 900 113		60	28.3	10.7	120	2100		included in the KIT 313 215 300 113		without preliminary setup	S	CAN	C	E	D	L	V	75
Mercedes A Class Saloon W177 inc. AMG exc. vehicles with aerodynamic package	09/18-			313 639 600 001		60	25.3	10.7	120	2100		313 215 300 113		without preliminary setup	S	CAN	C	E	D	L	V	75
				313 640 600 001		60	26.7	10.7	120	2100												





















Mercedes-Benz

















Mercedes A Class Saloon W177 without preliminary setup inc. AMG exc. vehicles with aerodynamic package	09/18-	KIT		313 639 900 113		60	24.9	10.7	120	2100		included in the KIT 313 215 300 113	without preliminary setup	S	CAN	C	E	D	L	V	75
		KIT		313 640 900 113		60	28.3	10.7	120	2100		included in the KIT 313 215 300 113	without preliminary setup	S	CAN	C	E	D	L	V	75
Mercedes Atego towing bracket with integral underrun guard (supply in pairs only: 313404600002 + 31340460003) Please check tolerances when mounting (measures see "Universal HGV towing brackets). swap system or automatic bolt coupling permitted suitable towball: 329103600001	01/97-			313 404 600 001		90	69.0	25.1	150	3500		300 201 300 113	for 12V vehicles	--	A	--	E1	D1	--	V	
Mercedes Atego towing bracket with integral underrun guard (supply in pairs only: 3421794600002 + 342179600003) Please check tolerances when mounting (measures see "Universal HGV towing brackets). swap system or automatic bolt coupling permitted suitable towball: 329103600001	01/97-			342 179 600 001		90	76.0	23.5	150	3500		300 201 300 113	for 12V vehicles	--	A	--	E1	D1	--	V	
Mercedes B Class W245	06/05-10/11			313 171 600 001		120	18.0	8.5	80	1500		313 231 300 107	without preliminary setup	S	CAN	C	E	--	--	V	90
				313 231 600 001		120	18.0	8.5	80	1500		313 231 300 113		S	CAN	C	E	D1	L1	V	90
		KIT		313 171 900 113		120	19.0	8.5	80	1500		included in the KIT 313 231 300 113		S	CAN	C	E	D1	L1	V	90
		KIT		313 231 900 113		120	19.5	8.5	80	1500		included in the KIT 313 231 300 113		S	CAN	C	E	D1	L1	V	90

Mercedes B Class W246 exc. AMG and sportmodels exc. Electric Drive B250e Attention: Depending on the engine variation it may be necessary to change the cooling system of the vehicle.	11/11-12/18			313 396 600 001			60	23.0	9.2	80	1500		313 398 300 107			S	CAN	C	E	--	--	V	105
				313 398 600 001			60	25.0	9.2	80	1500		313 398 300 113			S	CAN	C	E	D	L	V	105
		KIT		313 396 900 113			60	25.0	9.2	80	1900		included in the KIT 313 398 300 113			S	CAN	C	E	D	L	V	105
		KIT		313 398 900 113			60	27.0	9.2	80	1500		included in the KIT 313 398 300 113			S	CAN	C	E	D	L	V	105
Mercedes B Class W247	12/18-			313 639 600 001		60	25.3	10.7	120	2100		313 215 300 113		without preliminary setup	S	CAN	C	E	D	L	V	75	
				313 640 600 001		60	26.7	10.7	120	2100													
Mercedes B Class W247 without preliminary setup	12/18-	KIT		313 639 900 113		60	24.9	10.7	120	2100		included in the KIT 313 215 300 113		without preliminary setup	S	CAN	C	E	D	L	V	75	
		KIT		313 640 900 113		60	28.3	10.7	120	2100		included in the KIT 313 215 300 113		without preliminary setup	S	CAN	C	E	D	L	V	75	
Mercedes C Class Convertible A205 exc. AMG C63, AMG C63S inc. AMG look exc. vehicles with height control	07/16-06/18	KIT		313 431 900 113		120	23.0	10.5	85	1900		included in the KIT 313 432 300 113		-06/18	S	CAN	C	E	D	L1	H	45	
Mercedes C Class Convertible A205 exc. AMG C63, AMG C63S inc. AMG look inc. vehicles with height control	07/16-06/18	KIT		313 432 900 113		120	24.0	10.5	85	1900		included in the KIT 313 432 300 113		-06/18	S	CAN	C	E	D	L1	H	45	
Mercedes C Class Convertible C205 exc. AMG C63, AMG C63S inc. AMG look exc. vehicles with height control	07/16-03/23			313 431 600 001		120	21.0	10.5	85	1900		313 432 300 107		-06/18	S	CAN	C	E	--	--	H	45	
												313 432 300 113		-06/18	S	CAN	C	E	D	L1	H	45	
													313 445 300 113		07/18-03/23 inc. WLC 2.0	S	FRE	C	E	D	L1	H	60
Mercedes C Class Convertible A205 exc. AMG C63, AMG C63S inc. AMG look inc. vehicles with height control	07/16-03/23			313 432 600 001		120	23.0	10.5	85	1900		313 432 300 107		-06/18	S	CAN	C	E	--	--	H	45	
												313 432 300 113		-06/18	S	CAN	C	E	D	L1	H	45	
													313 445 300 113		07/18-03/23 inc. WLC 2.0	S	FRE	C	E	D	L1	H	60



















Mercedes-Benz















Mercedes-Benz

Mercedes C Class Convertible A205 exc. AMG C63, AMG C63S inc. AMG look exc. vehicles with height control	07/18-03/23	KIT		313 445 900 113		120	29.1	10.5	85	1900		included in the KIT 313 445 300 113	07/18-03/23 inc. WLC 2.0	S	FRE	C	E	D	L1	H	60
Mercedes C Class Convertible A205 exc. AMG C63, AMG C63S inc. AMG look inc. vehicles with height control	07/18-03/23	KIT		313 446 900 113		120	29.1	10.5	85	1900		included in the KIT 313 445 300 113	07/18-03/23 inc. WLC 2.0	S	FRE	C	E	D	L1	H	60
Mercedes C Class Coupé C204 + C204 AMG style	06/11-09/15			313 214 600 001		>150	21.0	10.2	75	1900		313 361 300 107		S	CAN	C	E	--	--	H	45
				313 438 600 001		120	23.0	10.2	75	1900		313 361 300 113		S	CAN	C	E	D	L	H	45
		KIT		313 389 900 113		>150	23.0	10.2	75	1900		included in the KIT 313 361 300 113		S	CAN	C	E	D	L	H	45
		KIT		313 211 900 113		>150	25.0	10.2	75	1900		included in the KIT 313 361 300 113		S	CAN	C	E	D	L	H	45
Mercedes C Class Coupé C205 exc. AMG C63, AMG C63S inc. AMG look exc. vehicles with height control	10/15-06/18	KIT		313 431 900 113		120	23.0	10.5	85	1900		included in the KIT 313 432 300 113	-06/18	S	CAN	C	E	D	L1	H	45
Mercedes C Class Coupé C205 exc. AMG C63, AMG C63S inc. AMG look inc. vehicles with height control	10/15-06/18	KIT		313 432 900 113		120	24.0	10.5	85	1900		included in the KIT 313 432 300 113	-06/18	S	CAN	C	E	D	L1	H	45
Mercedes C Class Coupé C205 exc. AMG C63, AMG C63S inc. AMG look exc. vehicles with height control	10/15-03/23			313 431 600 001		120	21.0	10.5	85	1900		313 432 300 107	-06/18	S	CAN	C	E	--	--	H	45
											313 432 300 113	-06/18	S	CAN	C	E	D	L1	H	45	
												313 445 300 113	07/18-03/23 inc. WLC 2.0	S	FRE	C	E	D	L1	H	60
Mercedes C Class Coupé C205 exc. AMG C63, AMG C63S inc. AMG look inc. vehicles with height control	10/15-03/23			313 432 600 001		120	23.0	10.5	85	1900		313 432 300 107	-06/18	S	CAN	C	E	--	--	H	45
											313 432 300 113	-06/18	S	CAN	C	E	D	L1	H	45	
												313 445 300 113	07/18-03/23 inc. WLC 2.0	S	FRE	C	E	D	L1	H	60

Mercedes C Class Coupé C205 exc. AMG C63, AMG C63S inc. AMG look exc. vehicles with height control	07/18-03/23	KIT		313 445 900 113		120	29.1	10.5	85	1900		included in the KIT 313 445 300 113	07/18-03/23 inc. WLC 2.0	S	FRE	C	E	D	L1	H	60
Mercedes C Class Coupé C205 exc. AMG C63, AMG C63S inc. AMG look inc. vehicles with height control	07/18-03/23	KIT		313 446 900 113		120	29.1	10.5	85	1900		included in the KIT 313 445 300 113	07/18-03/23 inc. WLC 2.0	S	FRE	C	E	D	L1	H	60
Mercedes C Class Estate S203 with steel springs exc. Sport Coupé, CLK from 05/02, AMG and 4x4	06/01-09/07			313 166 600 001		>150	22.0	9.1	75	1600		313 168 300 113		S	CAN	C	E	D	--	H	60
				313 167 600 001		>150	23.8	9.1	75	1600				S	CAN	C	E	D	--	H	60
		KIT		313 166 900 113		>150	24.0	9.1	75	1600		included in the KIT 313 168 300 113		S	CAN	C	E	D	--	H	60
		KIT		313 167 900 113		>150	25.5	9.1	75	1600		included in the KIT 313 168 300 113		S	CAN	C	E	D	--	H	60
Mercedes C Class Estate S204 exc. vehicles with height control, exc. AMG & sport bumpers inc. vehicles with AMG look (=> visible bumper cutout)	09/07-07/09	KIT		313 214 900 113		>150	23.0	10.2	75	1900		included in the KIT 313 210 300 113	-07/09 If a SAM-Low control unit is installed, it must be replaced by a higher quality SAM-High. Please observe the manufacturer's specifications.	S	CAN	C	E	D	L	H	45
		KIT		313 315 900 113		>150	25.0	10.2	75	1900				included in the KIT 313 210 300 113	-07/09 If a SAM-Low control unit is installed, it must be replaced by a higher quality SAM-High. Please observe the manufacturer's specifications.	S	CAN	C	E	D	L
Mercedes C Class Estate S204 exc. vehicles with height control, exc. AMG & sport bumpers inc. vehicles with AMG look (=> visible bumper cutout)	09/07-08/14			313 214 600 001		>150	21.0	10.2	75	1900		313 210 300 113	-07/09 If a SAM-Low control unit is installed, it must be replaced by a higher quality SAM-High. Please observe the manufacturer's specifications.	S	CAN	C	E	D	L	H	45
				313 438 600 001		120	23.0	10.2	75	1900					S	CAN	C	E	--	--	H
													313 361 300 107	07/09-	S	CAN	C	E	--	--	H
											313 361 300 113	07/09-	S	CAN	C	E	D	L	H	45	





















Mercedes-Benz

Mercedes C Class Estate S204 for vehicles with height control exc. AMG & sport bumpers inc. vehicles with AMG look (=> visible bumper cutout)	09/07-08/14			313 439 600 001	→ 	120	23.0	10.2	75	1900		313 210 300 113	-07/09 If a SAM-Low control unit is installed, it must be replaced by a higher quality SAM-High. Please observe the manufacturer's specifications.	S	CAN	C	E	D	L	H	45
												313 361 300 107	07/09-	S	CAN	C	E	--	--	H	45
												313 361 300 113	07/09-	S	CAN	C	E	D	L	H	45
Mercedes C Class Estate S204 exc. vehicles with height control, exc. AMG & sport bumpers inc. vehicles with AMG look (=> visible bumper cutout)	07/09-08/14	KIT		313 389 900 113		>150	23.0	10.2	75	1900		included in the KIT 313 361 300 113	07/09-	S	CAN	C	E	D	L	H	45
		KIT		313 211 900 113		>150	25.0	10.2	75	1900		included in the KIT 313 361 300 113	07/09-	S	CAN	C	E	D	L	H	45
Mercedes C Class Estate S205 exc. AMG C63, AMG C63S inc. AMG look exc. vehicles with height control	09/14-06/18	KIT		313 431 900 113		120	23.0	10.5	85	1900		included in the KIT 313 432 300 113	-06/18	S	CAN	C	E	D	L1	H	45
Mercedes C Class Estate S205 exc. AMG C63, AMG C63S inc. AMG look inc. vehicles with height control	09/14-06/18	KIT		313 432 900 113		120	24.0	10.5	85	1900		included in the KIT 313 432 300 113	-06/18	S	CAN	C	E	D	L1	H	45
Mercedes C Class Estate S205 exc. AMG C63, AMG C63S inc. AMG look exc. vehicles with height control	09/14-02/21			313 431 600 001		120	21.0	10.5	85	1900		313 432 300 107	-06/18	S	CAN	C	E	--	--	H	45
												313 432 300 113	-06/18	S	CAN	C	E	D	L1	H	45
												313 445 300 113	07/18- inc. WLC 2.0	S	FRE	C	E	D	L1	H	60
Mercedes C Class Estate S205 exc. AMG C63, AMG C63S inc. AMG look inc. vehicles with height control	09/14-02/21			313 432 600 001		120	23.0	10.5	85	1900		313 432 300 107	-06/18	S	CAN	C	E	--	--	H	45
												313 432 300 113	-06/18	S	CAN	C	E	D	L1	H	45
												313 445 300 113	07/18- inc. WLC 2.0	S	FRE	C	E	D	L1	H	60
Mercedes C Class Estate S205 exc. AMG C63, AMG C63S inc. AMG look exc. vehicles with height control	07/18-02/21	KIT		313 445 900 113		120	29.1	10.5	85	1900		included in the KIT 313 445 300 113	07/18- inc. WLC 2.0	S	FRE	C	E	D	L1	H	60
Mercedes C Class Estate S205 exc. AMG C63, AMG C63S inc. AMG look inc. vehicles with height control	07/18-02/21	KIT		313 446 900 113		120	29.1	10.5	85	1900		included in the KIT 313 445 300 113	07/18- inc. WLC 2.0	S	FRE	C	E	D	L1	H	60



















Mercedes C Class Estate S206 exc. AMG exc. Plugin-Hybrid	03/21-			313 709 600 001		90	18.3	10.1	120	1800																		
				313 710 600 001		90	21.7	10.1	120	1800																		
Mercedes C Class Saloon W203 with steel springs exc. Sport Coupé, CLK from 05/02, AMG	06/00-03/07			313 166 600 001		>150	22.0	9.1	75	1600																		
				313 167 600 001		>150	23.8	9.1	75	1600																		
		KIT		313 166 900 113		>150	24.0	9.1	75	1600																		
		KIT		313 167 900 113		>150	25.5	9.1	75	1600																		
Mercedes C Class Saloon W204 exc. vehicles with height control exc. AMG & sport bumpers, vehicles with AMG look	03/07-07/09	KIT		313 214 900 113		>150	23.0	10.2	75	1900																		
				313 315 900 113		>150	25.0	10.2	75	1900																		
Mercedes C Class Saloon W204 exc. vehicles with height control exc. AMG & sport bumpers, vehicles with AMG look	03/07-01/14			313 214 600 001		>150	21.0	10.2	75	1900																		























Mercedes-Benz

Mercedes C Class Saloon W204 exc. vehicles with height control exc. AMG & sport bumpers, vehicles with AMG look	03/07-01/14		313 438 600 001		120	23.0	10.2	75	1900		313 210 300 113	-07/09 If a SAM-Low control unit is installed, it must be replaced by a higher quality SAM-High. Please observe the manufacturer's specifications.	S	CAN	C	E	D	L	H	45
											313 361 300 107	07/09-	S	CAN	C	E	--	--	H	45
											313 361 300 113	07/09-	S	CAN	C	E	D	L	H	45
Mercedes C Class Saloon W204 inc. vehicles with height control, exc. AMG & sport bumpers	03/07-01/14		313 439 600 001	→	120	23.0	10.2	75	1900		313 210 300 113	-07/09 If a SAM-Low control unit is installed, it must be replaced by a higher quality SAM-High. Please observe the manufacturer's specifications.	S	CAN	C	E	D	L	H	45
											313 361 300 107	07/09-	S	CAN	C	E	--	--	H	45
											313 361 300 113	07/09-	S	CAN	C	E	D	L	H	45
Mercedes C Class Saloon W204 exc. vehicles with height control exc. AMG & sport bumpers, vehicles with AMG look	07/09-01/14	KIT	313 389 900 113		>150	23.0	10.2	75	1900		included in the KIT 313 361 300 113	07/09-	S	CAN	C	E	D	L	H	45
											KIT	313 211 900 113		>150	25.0	10.2	75	1900	included in the KIT 313 361 300 113	07/09-
Mercedes C Class Saloon W205 exc. AMG C63, AMG C63S inc. AMG look exc. vehicles with height control	03/14-06/18	KIT	313 431 900 113		120	23.0	10.5	85	1900		included in the KIT 313 432 300 113	-06/18	S	CAN	C	E	D	L1	H	45
Mercedes C Class Saloon W205 exc. AMG C63, AMG C63S inc. AMG look inc. vehicles with height control	03/14-06/18	KIT	313 432 900 113		120	24.0	10.5	85	1900		included in the KIT 313 432 300 113	-06/18	S	CAN	C	E	D	L1	H	45
Mercedes C Class Saloon W205 exc. AMG C63, AMG C63S inc. AMG look exc. vehicles with height control	03/14-02/21		313 431 600 001		120	21.0	10.5	85	1900		313 432 300 107	-06/18	S	CAN	C	E	--	--	H	45
											313 432 300 113	-06/18	S	CAN	C	E	D	L1	H	45
											313 445 300 113	07/18-02/21 inc. WLC 2.0	S	FRE	C	E	D	L1	H	60
Mercedes C Class Saloon W205 exc. AMG C63, AMG C63S inc. AMG look inc. vehicles with height control	03/14-02/21		313 432 600 001		120	23.0	10.5	85	1900		313 432 300 107	-06/18	S	CAN	C	E	--	--	H	45
											313 432 300 113	-06/18	S	CAN	C	E	D	L1	H	45
											313 445 300 113	07/18-02/21 inc. WLC 2.0	S	FRE	C	E	D	L1	H	60























Mercedes C Class Saloon W205 exc. AMG C63, AMG C63S inc. AMG look exc. vehicles with height control	07/18-02/21	KIT		313 445 900 113		120	29.1	10.5	85	1900		included in the KIT 313 445 300 113	07/18-02/21 inc. WLC 2.0	S	FRE	C	E	D	L1	H	60	
Mercedes C Class Saloon W205 exc. AMG C63, AMG C63S inc. AMG look inc. vehicles with height control	07/18-02/21	KIT		313 446 900 113		120	29.1	10.5	85	1900		included in the KIT 313 445 300 113	07/18-02/21 inc. WLC 2.0	S	FRE	C	E	D	L1	H	60	
Mercedes C Class Saloon W206 exc. AMG exc. Plugin-Hybrid	03/21-			313 709 600 001		90	18.3	10.1	120	1800												
				313 710 600 001		90	21.7	10.1	120	1800												
Mercedes CLA C117 inc. vehicles with AMG look inc. CLA Shooting Brake (X117) 03/15- Attention: Depending on the engine variation it may be necessary to change the cooling system of the vehicle.	04/13-03/19			313 396 600 001		60	23.0	9.2	80	1500		313 398 300 107		S	CAN	C	E	--	--	V	105	
				313 503 600 001		60	24.5	10.2	80	1900		313 398 300 113		S	CAN	C	E	D	L	V	105	
		KIT		313 396 900 113		60	25.0	9.2	80	1900		included in the KIT 313 398 300 113		S	CAN	C	E	D	L	V	105	
		KIT		313 400 900 113		60	26.0	10.2	80	1900		included in the KIT 313 398 300 113		S	CAN	C	E	D	L	V	105	
Mercedes CLA II Coupé C118 inc. AMG exc. vehicles with aerodynamic package	04/19-			313 640 600 001		60	26.7	10.7	120	2100		313 215 300 113	04/19- without preliminary setup	S	CAN	C	E	D	L	V	75	
Mercedes CLA II Coupé C118 inc. AMG exc. vehicles with aerodynamic package	04/19-			313 639 600 001		60	25.3	10.7	120	2100		313 215 300 113	04/19- without preliminary setup	S	CAN	C	E	D	L	V	75	
Mercedes CLA II Coupé C118 without preliminary setup inc. AMG exc. vehicles with aerodynamic package	04/19-	KIT		313 639 900 113		60	24.9	10.7	120	2100		included in the KIT 313 215 300 113	04/19- without preliminary setup	S	CAN	C	E	D	L	V	75	
		KIT		313 640 900 113		60	28.3	10.7	120	2100		included in the KIT 313 215 300 113	04/19- without preliminary setup	S	CAN	C	E	D	L	V	75	

























Mercedes-Benz

Mercedes CLA II Shooting Brake X118 inc. AMG exc. vehicles with aerodynamic package	06/19-			313 639 600 001		60	25.3	10.7	120	2100	313 215 300 113	without preliminary setup	S	CAN	C	E	D	L	V	75	
				313 640 600 001		60	26.7	10.7	120	2100											
Mercedes CLA II Shooting Brake X118 without preliminary setup inc. AMG exc. vehicles with aerodynamic package	06/19-	KIT		313 639 900 113		60	24.9	10.7	120	2100	included in the KIT 313 215 300 113	without preliminary setup	S	CAN	C	E	D	L	V	75	
			KIT		313 640 900 113		60	28.3	10.7	120	2100	included in the KIT 313 215 300 113	without preliminary setup	S	CAN	C	E	D	L	V	75
Mercedes CLC is not permitted to tow by the vehicle manufacturer.																					
Mercedes CLS Shooting Brake X218 inc. vehicles with AMG look	10/12-12/17			313 371 600 001		150	26.0	11.5	84	2100	313 361 300 107		S	CAN	C	E	--	--	H	45	
				313 373 600 001		150	27.0	11.5	84	2100	313 361 300 113		S	CAN	C	E	D	L	H	45	
		KIT		313 371 900 113		150	30.6	11.5	84	2100	included in the KIT 313 361 300 113		S	CAN	C	E	D	L	H	45	
		KIT		313 373 900 113		150	32.5	11.5	84	2100	included in the KIT 313 361 300 113		S	CAN	C	E	D	L	H	45	
Mercedes Citan length = 4321 + 4705 mm exc. AdBlue	10/12-08/21			316 268 600 001		60	23.0	8.2	75	1350	316 353 300 113		S	FRE	--		D1	L1	H	60	
				316 269 600 001		60	23.0	8.2	75	1350											
		KIT		316 352 900 113		60	25.0	8.2	75	1350	included in the KIT 316 353 300 113		S	FRE	--		D1	L1	H	60	
		KIT		316 353 900 113		60	25.0	8.2	75	1350	included in the KIT 316 353 300 113		S	FRE	--		D1	L1	H	60	
Mercedes Citan II W420	09/21-			316 492 600 001		90	26.7	9.4	114	1500	316 493 300 113	09/21-	S	FRE	--	E	D1	L1	H	60	

Mercedes Citan II W420 without preliminary setup for vehicles without spare wheel	09/21-	KIT		316 492 900 113		90	28.3	9.4	114	1500		included in the KIT 316 493 300 113	09/21-	S	FRE	--	E	D1	L1	H	60
Mercedes E Class Convertible A207 exc. AMG vehicles, exc. vehicles with AMG look	03/10-12/16			313 214 600 001		>150	21.0	10.2	75	1900		313 361 300 107		S	CAN	C	E	--	--	H	45
				313 438 600 001		120	23.0	10.2	75	1900		313 361 300 113		S	CAN	C	E	D	L	H	45
		KIT		313 389 900 113		>150	23.0	10.2	75	1900		included in the KIT 313 361 300 113		S	CAN	C	E	D	L	H	45
		KIT		313 211 900 113		>150	25.0	10.2	75	1900		included in the KIT 313 361 300 113		S	CAN	C	E	D	L	H	45
Mercedes E Class Coupé C207 exc. AMG vehicles, exc. vehicles with AMG look	05/09-12/16			313 214 600 001		>150	21.0	10.2	75	1900		313 361 300 107		S	CAN	C	E	--	--	H	45
				313 438 600 001		120	23.0	10.2	75	1900		313 361 300 113		S	CAN	C	E	D	L	H	45
		KIT		313 389 900 113		>150	23.0	10.2	75	1900		included in the KIT 313 361 300 113		S	CAN	C	E	D	L	H	45
		KIT		313 211 900 113		>150	25.0	10.2	75	1900		included in the KIT 313 361 300 113		S	CAN	C	E	D	L	H	45
Mercedes E Class Estate S212 inc. AMG styling package	09/09-03/16			313 371 600 001		150	26.0	11.5	84	2100		313 361 300 107		S	CAN	C	E	--	--	H	45
				313 373 600 001		150	27.0	11.5	84	2100		313 361 300 113		S	CAN	C	E	D	L	H	45
		KIT		313 371 900 113		150	30.6	11.5	84	2100		included in the KIT 313 361 300 113		S	CAN	C	E	D	L	H	45
		KIT		313 373 900 113		150	32.5	11.5	84	2100		included in the KIT 313 361 300 113		S	CAN	C	E	D	L	H	45



















Mercedes-Benz





















Mercedes E Class Estate S213 inc. vehicles with AMG look Plug-in-Hybrid: Please note D value inc. facelift 2021- exc. E63 AMG	04/16-08/23			313 523 600 001		60	23.8	11.8	140	2100		313 446 300 113	-08/23	S	CAN	C	E	D	L	H	60	
				313 524 600 001		60	25.1	11.8	140	2100												
		KIT		313 523 900 113		60	24.7	11.8	140	2100		included in the KIT 313 446 300 113	-08/23	S	CAN	C	E	D	L	H	60	
		KIT		313 524 900 113		60	26.0	11.8	140	2100		included in the KIT 313 446 300 113	-08/23	S	CAN	C	E	D	L	H	60	
Mercedes E Class Saloon W211 exc. AMG, inc. 4-Matic If there are no reinforcements right and left in the boot, it is necessary to mount them. You can buy them at the DC dealer, DC no. A 211 639 0143 and A 211 639 0443. With this reinforcements the coverings of the sides don't fit anymore. You could buy others at the DC dealer, e.g. A 211 690 9425 / 9825. The supercharger of the cooling must have a power of 600 W. The superchargers A 001 500 4493 and A 211 500 0693 fulfil this requirement.	03/02-09			313 195 600 001		150	24.5	11.0	80	2000		313 196 300 113		S	CAN	C	E	D	--	H	60	
		KIT		313 195 900 113		150	25.0	11.0	80	2000		included in the KIT 313 196 300 113		S	CAN	C	E	D	--	H	60	
Mercedes E Class Saloon W212	03/09-12/15			313 361 600 001		90	31.0	11.4	84	2100		313 361 300 107		S	CAN	C	E	--	--	H	45	
				313 361 600 001		90	31.0	11.4	84	2100		313 361 300 113		S	CAN	C	E	D	L	H	45	
Mercedes E Class Saloon W212	03/09-12/15	KIT		313 361 900 113		90	32.0	11.4	84	2100		included in the KIT 313 361 300 113		S	CAN	C	E	D	L	H	45	
				313 523 600 001		60	23.8	11.8	140	2100		313 446 300 113	-08/23	S	CAN	C	E	D	L	H	60	
Mercedes E Class Saloon W213 inc. vehicles with AMG look Plug-in-Hybrid: Please note D value inc. facelift 2021- exc. E63 AMG	01/16-08/23			313 524 600 001		60	25.1	11.8	140	2100												
				313 524 600 001		60	25.1	11.8	140	2100												
		KIT		313 523 900 113		60	24.7	11.8	140	2100		included in the KIT 313 446 300 113	-08/23	S	CAN	C	E	D	L	H	60	
		KIT		313 524 900 113		60	26.0	11.8	140	2100		included in the KIT 313 446 300 113	-08/23	S	CAN	C	E	D	L	H	60	





Mercedes EQC N293	05/19-			313 562 600 001		60	26.7	13.3	160	2600		313 445 300 113		05/19- 2.0	inc. WLC	S	FRE	C	E	D	L1	H	60		
Mercedes EQV W447	06/20-			313 435 600 001		90	20.0	13.8	100	2500															
				313 436 600 001		90	21.0	13.8	100	2500															
Mercedes G Class only for vehicles with 2-parts rear bumper	02/90-			313 320 600 001		60	12.0	17.2	140	3500		300 210 300 113				--	A	--	E1	D1	L1	V	90		
Mercedes GL Class X164/X166 inc. 8 cylinder diesel exc. vehicles with AMG look For vehicles with AdBlue tank please order: holder 913406609103	09/06-12/15			313 421 600 001		120	38.0	16.5	135	3500		313 138 300 113					S	CAN	C	E	D	L	H	45	
				313 430 300 113												X166		S	CAN	C1	E	D	L1	H	60
Mercedes GLA X156 exc. AMG	03/14-12/19			313 401 600 001		60	21.0	10.2	80	1900		313 398 300 107					S	CAN	C	E	--	--	V	105	
				313 398 300 113														S	CAN	C	E	D	L	V	105
			KIT 	313 401 900 113				60	24.0	10.2	80	1900		included in the KIT 313 398 300 113				S	CAN	C	E	D	L	V	105
Mercedes GLA X156 inc. vehicles with AMG look (bumper cut necessary)	03/14-12/19			313 503 600 001		60	24.5	10.2	80	1900		313 398 300 107					S	CAN	C	E	--	--	V	105	
				313 398 300 113														S	CAN	C	E	D	L	V	105
Mercedes GLA (H247) inc. Hybrid inc. AdBlue inc. GLA 35 + 45 AMG exc. vehicles with aerodynamic package	02/20-			313 639 600 001		60	25.3	10.7	120	2100		313 215 300 113					S	CAN	C	E	D	L	V	75	
				313 640 600 001		60	26.7	10.7	120	2100															
Mercedes GLA (H247) without preliminary setup inc. Hybrid inc. AdBlue inc. GLA 35 + 45 AMG exc. vehicles with aerodynamic package	02/20-	KIT		313 639 900 113		60	24.9	10.7	120	2100		included in the KIT 313 215 300 113					S	CAN	C	E	D	L	V	75	
				313 640 900 113		60	28.3	10.7	120	2100		included in the KIT 313 215 300 113						S	CAN	C	E	D	L	V	75

Mercedes-Benz





Mercedes-Benz







Mercedes GLB (X247) inc. Hybrid inc. AdBlue inc. GLB 35 AMG	08/19-			313 639 600 001		60	25.3	10.7	120	2100	313 215 300 113	without preliminary setup	S	CAN	C	E	D	L	V	75
				313 640 600 001		60	26.7	10.7	120	2100										
Mercedes GLB (X247) without preliminary setup inc. Hybrid inc. AdBlue inc. GLB 35 AMG	08/19-	KIT		313 639 900 113		60	24.9	10.7	120	2100	included in the KIT 313 215 300 113	without preliminary setup	S	CAN	C	E	D	L	V	75
				313 640 900 113		60	28.3	10.7	120	2100	included in the KIT 313 215 300 113	without preliminary setup	S	CAN	C	E	D	L	V	75
Mercedes GLC X253 inc. vehicles with height control inc. vehicles with AMG look for vehicles with rear flap sensor - Please regard fitting instruction - wire for sensor must be adjusted For Hybrid only: Order a frame reinforcement kit from the vehicle manufacturer.	09/15-06/19	KIT		313 402 900 113		90	24.4	13.2	100	2500	included in the KIT 313 432 300 113	-06/19	S	CAN	C	E	D	L1	H	45
				313 403 900 113		90	27.6	13.2	100	2500	included in the KIT 313 432 300 113	-06/19	S	CAN	C	E	D	L1	H	45
Mercedes GLC X253 inc. vehicles with height control inc. vehicles with AMG look for vehicles with rear flap sensor - Please regard fitting instruction - wire for sensor must be adjusted For Hybrid only: Order a frame reinforcement kit from the vehicle manufacturer.	09/15-05/22			313 402 600 001		90	23.0	13.2	100	2500	313 432 300 107	-06/19	S	CAN	C	E	--	--	H	45
											313 432 300 113	-06/19	S	CAN	C	E	D	L1	H	45
											313 445 300 113	07/19- inc. WLC 2.0	S	FRE	C	E	D	L1	H	60
Mercedes GLC X253 inc. vehicles with height control inc. vehicles with AMG look for vehicles with rear flap sensor - Please regard fitting instruction - wire for sensor must be adjusted For Hybrid only: Order a frame reinforcement kit from the vehicle manufacturer.	09/15-05/22			313 403 600 001		90	25.0	13.2	100	2500	313 432 300 107	-06/19	S	CAN	C	E	--	--	H	45
											313 432 300 113	-06/19	S	CAN	C	E	D	L1	H	45
											313 445 300 113	07/19- inc. WLC 2.0	S	FRE	C	E	D	L1	H	60
Mercedes GLC X253 inc. vehicles with height control inc. vehicles with AMG look for vehicles with rear flap sensor - Please regard fitting instruction - wire for sensor must be adjusted For Hybrid only: Order a frame reinforcement kit from the vehicle manufacturer.	07/19-05/22	KIT		313 404 900 113		60	24.4	13.2	100	2500	included in the KIT 313 445 300 113	07/19- inc. WLC 2.0	S	FRE	C	E	D	L1	H	60

Mercedes GLC X253 inc. vehicles with height control inc. vehicles with AMG look for vehicles with rear flap sensor - Please regard fitting instruction - wire for sensor must be adjusted For Hybrid only: Order a frame reinforcement kit from the vehicle manufacturer.	07/19-07/22	KIT		313 405 900 113		60	27.6	13.2	100	2500		included in the KIT 313 445 300 113	07/19- 2.0	inc. WLC	S	FRE	C	E	D	L1	H	60
Mercedes GLE W166 inc. vehicles with AMG look exc. GLE Coupé	04/15-09/18			313 406 600 001		90	50.0	16.8	140	3500		313 430 300 113	-09/18		S	CAN	C1	E	D	L1	H	60
		KIT		313 406 900 113		90	51.8	16.8	140	3500		included in the KIT 313 430 300 113	-09/18		S	CAN	C1	E	D	L1	H	60
Mercedes GLE V167 / W167 exc. Hybrid enc. AMG	10/18-			313 661 600 001		60	34.4	16.0	140	3500		313 446 300 113	10/18- 2.0	inc. WLC	S	CAN	C	E	D	L	H	60
				313 662 600 001		60	37.3	16.0	140	3500												
		KIT		313 661 900 113		60	36.1	16.0	140	3500		included in the KIT 313 446 300 113	10/18- 2.0	inc. WLC	S	CAN	C	E	D	L	H	60
		KIT		313 662 900 113		60	38.0	16.0	140	3500		included in the KIT 313 446 300 113	10/18- 2.0	inc. WLC	S	CAN	C	E	D	L	H	60
Mercedes GLE Coupé C292	03/15-10/19			313 515 600 001		90	40.5	16.8	140	3500		313 430 300 113			S	CAN	C1	E	D	L1	H	60
Mercedes GLK X204	06/08-12/15			313 433 600 001		90	22.0	12.8	100	2500		313 210 300 113	-07/09	If a SAM- Low control unit is installed, it must be replaced by a higher quality SAM-High. Please observe the manufacturer's specifications.	S	CAN	C	E	D	L	H	45
				313 434 600 001		90	23.0	12.8	100	2500												
													313 361 300 107	07/09-		S	CAN	C	E	--	--	H
											313 361 300 113	07/09-		S	CAN	C	E	D	L	H	45	







<p>Mercedes Sprinter Van without preliminary setup types 209-224 and 309-324 Vehicles with 3,0 and 3,5 t max. total weight, increase to 3,8 t max. total weight is possible For vehicles with integrated step device in the bumper the middle part of the outer bumper must be exchanged (Please order separately at Mercedes dealers.). inc. towball Step DC-IR A906 520 0531 is not utilisabile. Utilisable step: 313285600001 or 313440600001</p>	04/06-12/14	KIT		313 376 900 113		120	22.0	18.1	150	3500		included in the KIT 313 105 300 113		-12/14 for vehicles without preparation	S	CAN	C	E	D1	--	V	90
<p>Mercedes Sprinter Van without preliminary setup types 209-224 and 309-324 for vehicles with step Vehicles with 3,0 and 3,5 t max. total weight, increase to 3,8 t max. total weight is possible fitting ball plate 329076600001 exc. wheelbase = 3250 mm</p>	04/06-12/14	KIT		313 105 900 113		60	34.0	17.6	120	2800		included in the KIT 313 105 300 113		-12/14 for vehicles without preparation	S	CAN	C	E	D1	--	V	90
<p>Mercedes Sprinter Van types 411-424 and 509-524 Vehicles with 5,0 t max. total weight, reduction to 4,6 t max. total weight is possible. wheelbase: 3665 mm For vehicles with integrated step device in the bumper the middle part of the outer bumper must be exchanged (Please order separately at Mercedes dealers.). towball: 329141600001 (order separately) Step DC-IR A906 520 0531 is not utilisabile. Utilisable step: 313285600001 or 313440600001</p>	04/06-01/18			313 272 600 001		120	22.0	20.2	150	3500		313 105 300 107 313 105 300 113 313 107 300 113 313 108 300 113 321 106 300 113	→	-12/14 for vehicles without preparation -12/14 for vehicles without preparation 01/15-01/18 for vehicles with preparation 01/15-01/18 for vehicles without preparation -12/14 vehicles with preparation	S	CAN	C	E	--	--	V	90



Mercedes-Benz

Mercedes Sprinter Van types 411-424 and 509-524 Vehicles with 5,0 t max. total weight, reduction to 4,6 t max. total weight is possible. wheelbase: 4325 mm For vehicles with integrated step device in the bumper the middle part of the outer bumper must be exchanged (Please order separately at Mercedes dealers.). towball: 329141600001 (order seperately) Step DC-IR A906 520 0531 is not utilisable. Utilisable step: 313285600001 or 313440600001	04/06-01/18		313 273 600 001		120	23.0	20.2	150	3500	313 105 300 107	→	-12/14 for vehicles without preparation	S	CAN	C	E	--	--	V	90
										313 105 300 113		-12/14 for vehicles without preparation	S	CAN	C	E	D1	--	V	90
										313 107 300 113		01/15-01/18 for vehicles with preparation	S	CAN	C	E	D1	L1	H	45
										313 108 300 113		01/15-01/18 for vehicles without preparation	S	CAN	C	E	D1	L1	V	90
										321 106 300 113		-12/14 vehicles with preparation	S	CAN	C	E	D	--	H	45
Mercedes Sprinter Van types 209-224 and 309-324 frontwheeldrive -01/18 Vehicles with 3,0 and 3,5 t max. total weight, increase to 3,8 t max. total weight is possible For vehicles with integrated step device in the bumper the middle part of the outer bumper must be exchanged (Please order separately at Mercedes dealers.). towball: 329141600001 Step DC-IR A906 520 0531 is not utilisable. Utilisable step: 313285600001 or 313440600001	04/06-01/18		313 376 600 001		120	20.0	18.1	150	3500	313 105 300 107	→	-12/14 for vehicles without preparation	S	CAN	C	E	--	--	V	90
										313 105 300 113		-12/14 for vehicles without preparation	S	CAN	C	E	D1	--	V	90
										313 107 300 113		01/15-01/18 for vehicles with preparation	S	CAN	C	E	D1	L1	H	45
										313 108 300 113		01/15-01/18 for vehicles without preparation	S	CAN	C	E	D1	L1	V	90
										321 106 300 113		-12/14 vehicles with preparation	S	CAN	C	E	D	--	H	45
Mercedes Sprinter Van types 209-224 and 309-324 for vehicles with step Vehicles with 3,0 and 3,5 t max. total weight, increase to 3,8 t max. total weight is possible fitting ball plate 329076600001 exc. wheelbase = 3250 mm	04/06-01/18		313 553 600 001		60	31.8	17.6	120	2800	313 105 300 107	→	-12/14 for vehicles without preparation	S	CAN	C	E	--	--	V	90
										313 105 300 113		-12/14 for vehicles without preparation	S	CAN	C	E	D1	--	V	90
										313 107 300 113		01/15-01/18 for vehicles with preparation	S	CAN	C	E	D1	L1	H	45
										313 108 300 113		01/15-01/18 for vehicles without preparation	S	CAN	C	E	D1	L1	V	90
										321 106 300 113		-12/14 vehicles with preparation	S	CAN	C	E	D	--	H	45

Mercedes Sprinter Van without preliminary setup types 209-224 and 309-324 Vehicles with 3,0 and 3,5 t max. total weight, increase to 3,8 t max. total weight is possible For vehicles with integrated step device in the bumper the middle part of the outer bumper must be exchanged (Please order separately at Mercedes dealers.). inc. towball Step DC-IR A906 520 0531 is not utilisable. Utilisable step: 313285600001 or 313440600001	01/15-01/18	KIT		313 108 900 113			120	23.0	18.1	150	3500			included in the KIT 313 108 300 113	01/15-01/18 for vehicles without preparation	S	CAN	C	E	D1	L1	V	90
Mercedes Sprinter Van without preliminary setup inc. towball types 209-224 and 309-324 for vehicles with step Vehicles with 3,0 and 3,5 t max. total weight, increase to 3,8 t max. total weight is possible exc. wheelbase = 3250 mm	01/15-01/18	KIT		313 553 900 113			60	34.0	17.6	120	2800			included in the KIT 313 108 300 113	01/15-01/18 for vehicles without preparation	S	CAN	C	E	D1	L1	V	90
Mercedes Sprinter Van 907 + 910 not for vehicles with AWD and twin tires Vehicles up to 3.5 tons including ball plate for vehicles without step swap system allowed	02/18-			313 641 600 001			60	21.7	20.2	150	3500		313 217 300 113	02/18- inc. WLC 2.0	S	FRE	C	E	D	L1	V	75	
		KIT		313 641 900 113			60	23.4	20.2	150	3500			included in the KIT 313 217 300 113	02/18- inc. WLC 2.0	S	FRE	C	E	D	L1	V	75
Mercedes Sprinter Van types 907 and 910 Vehicles with 5,0 t max. total weight, reduction to 4,6 t max. total weight is possible. wheelbase: 3665 mm For vehicles with integrated step device in the bumper the middle part of the outer bumper must be exchanged (Please order separately at Mercedes dealers.). towball: 329141600001 (order seperately) Utilisable step: 313285600001 or 313440600001	02/18-			313 272 600 001			120	22.0	20.2	150	3500			313 217 300 113	02/18- inc. WLC 2.0	S	FRE	C	E	D	L1	V	75



















Mercedes-Benz























<p>Mercedes Sprinter Van types 907 and 910 Vehicles with 5,0 t max. total weight, reduction to 4,6 t max. total weight is possible. wheelbase: 4325 mm For vehicles with integrated step device in the bumper the middle part of the outer bumper must be exchanged (Please order separately at Mercedes dealers.). towball: 329141600001 (order seperately) Utilisable step: 313285600001 or 313440600001</p>	02/18-			313 273 600 001			120	23.0	20.2	150	3500		313 217 300 113	02/18- 2.0	inc. WLC	S	FRE	C	E	D	L1	V	75
<p>Mercedes Sprinter Van W910 front wheel drive for vehicles with step</p>	02/18-			313 680 600 001			30	29.0	12.5	150	2000		313 217 300 113	02/18- 2.0	inc. WLC	S	FRE	C	E	D	L1	V	75
<p>Mercedes Sprinter Chassis Cab without preliminary setup types 411-424 and 509-524 Vehicles with 5,0 t max. total weight, reduction to 4,6 t max. total weight is possible wheelbase: 3665 + 4325 mm inc. towball</p>	04/06-12/14	KIT		313 275 900 113			90	20.0	20.2	150	3500	included in the KIT 313 105 300 113		-12/14 for vehicles without preparation	S	CAN	C	E	D1	--	V	90	
<p>Mercedes Sprinter Chassis Cab without preliminary setup types 209-224 and 309-324 Vehicles with 3,0 and 3,5 t max. total weight, increase to 3,8 t max. total weight is possible exc. vehicles with underrun guard inc. towball</p>	04/06-12/14	KIT		313 377 900 113	→ 		90	22.0	18.1	150	3500	included in the KIT 313 105 300 113		-12/14 for vehicles without preparation	S	CAN	C	E	D1	--	V	90	
<p>Mercedes Sprinter Chassis Cab without preliminary setup - 3,8 t types 209-224 and 309-324 exc. vehicles with underrun guard inc. towball 329080600001</p>	04/06-12/14	KIT		313 522 900 113			60	21.8	20.2	240	3500	included in the KIT 313 105 300 113		-12/14 for vehicles without preparation	S	CAN	C	E	D1	--	V	90	

Mercedes Sprinter Chassis Cab types 411-424 and 509-524 Vehicles with 5,0 t max. total weight, reduction to 4,6 t max. total weight is possible wheelbase: 3665 + 4325 mm towball: 329059600001	04/06-01/18		313 275 600 001			90	18.0	20.2	150	3500		313 105 300 107	→	-12/14 for vehicles without preparation	S	CAN	C	E	--	--	V	90
												313 105 300 113		-12/14 for vehicles without preparation	S	CAN	C	E	D1	--	V	90
												313 107 300 113		01/15-01/18 for vehicles with preparation	S	CAN	C	E	D1	L1	H	45
												313 108 300 113		01/15-01/18 for vehicles without preparation	S	CAN	C	E	D1	L1	V	90
												321 106 300 113		-12/14 vehicles with preparation	S	CAN	C	E	D	--	H	45
Mercedes Sprinter Chassis Cab types 209-224 and 309-324 Vehicles with 3,0 and 3,5 t max. total weight, increase to 3,8 t max. total weight is possible exc. vehicles with underrun guard towball: 329059600001	04/06-01/18		313 377 600 001	→		90	20.0	18.1	150	3500		313 105 300 107	→	-12/14 for vehicles without preparation	S	CAN	C	E	--	--	V	90
												313 105 300 113		-12/14 for vehicles without preparation	S	CAN	C	E	D1	--	V	90
												313 107 300 113		01/15-01/18 for vehicles with preparation	S	CAN	C	E	D1	L1	H	45
												313 108 300 113		01/15-01/18 for vehicles without preparation	S	CAN	C	E	D1	L1	V	90
												321 106 300 113		-12/14 vehicles with preparation	S	CAN	C	E	D	--	H	45
Mercedes Sprinter Chassis Cab - 3,8 t types 209-224 and 309-324 exc. vehicles with underrun guard inc. towball	04/06-01/18		313 522 600 001			60	19.6	20.2	240	3500		313 105 300 107	→	-12/14 for vehicles without preparation	S	CAN	C	E	--	--	V	90
												313 105 300 113		-12/14 for vehicles without preparation	S	CAN	C	E	D1	--	V	90
												313 107 300 113		01/15-01/18 for vehicles with preparation	S	CAN	C	E	D1	L1	H	45
												313 108 300 113		01/15-01/18 for vehicles without preparation	S	CAN	C	E	D1	L1	V	90
												321 106 300 113		-12/14 vehicles with preparation	S	CAN	C	E	D	--	H	45

Mercedes-Benz









Mercedes-Benz

Mercedes Sprinter Chassis Cab without preliminary setup - 3,8 t types 209-224 and 309-324 exc. vehicles with underrun guard inc. towball 329080600001	01/15-01/18	KIT		313 107 900 113			60	22.9	20.2	240	3500			included in the KIT 313 108 300 113		01/15-01/18 for vehicles without preparation	S	CAN	C	E	D1	L1	V	90	
Mercedes Sprinter Chassis Cab 907 + 910 towball inc. for vehicles without step exc. vehicles with underrun protection under the rear crossmember (EG according to data card C71) exc. vehicles with 5,0 and 5,5 t total weight swap system allowed	02/18-			313 641 600 001			60	21.7	20.2	150	3500			313 217 300 113		02/18- inc. WLC 2.0	S	FRE	C	E	D	L1	V	75	
		KIT		313 641 900 113			60	23.4	20.2	150	3500			included in the KIT 313 217 300 113		02/18- inc. WLC 2.0	S	FRE	C	E	D	L1	V	75	
Mercedes Class T W420 exc. vehicles with towbar preparation exc. vehicles with spare wheel	05/22-			316 492 600 001			90	26.7	9.4	114	1500			316 493 300 113			S	FRE	--	E	D1	L1	H	60	
Mercedes Class T W420 exc. vehicles with towbar preparation exc. vehicles with spare wheel	07/22-	KIT		316 492 900 113			90	28.3	9.4	114	1500			included in the KIT 316 493 300 113			S	FRE	--	E	D1	L1	H	60	
Mercedes Class V W447 inc. 4x4	04/14-			313 435 600 001			90	20.0	13.8	100	2500			313 436 300 113			S	CAN	C	E2	D	L1	V	90	
				313 436 600 001			90	21.0	13.8	100	2500														
		KIT		313 435 900 113			90	22.0	13.8	100	2500			included in the KIT 313 436 300 113			S	CAN	C	E2	D	L1	V	90	
		KIT		313 436 900 113			90	23.0	13.8	100	2500			included in the KIT 313 436 300 113			S	CAN	C	E2	D	L1	V	90	
Mercedes Viano / V Class from chassis no. 16793 inc. 4x4	02/04-04/14			313 240 600 001			120	19.0	13.8	150	2500			313 176 300 113			S	--	E1	D1	L1			75	
		KIT		313 240 900 113			120	20.5	13.8	150	2500			included in the KIT 313 176 300 113			S	--	E1	D1	L1			75	

















Mercedes Viano / V Class from chassis no. 16793 inc. 4x4, exc. Brabus Please order separately cover for bumper cutout at Mercedes dealer's.	02/04-04/14			313 382 600 001		90	20.0	13.5	150	2500		313 176 300 113			S	--	E1	D1	L1			75
		KIT		313 382 900 113		90	22.0	13.5	150	2500		included in the KIT 313 176 300 113			S	--	E1	D1	L1			75
Mercedes Vito from chassis no. 16793 inc. 4x4, exc. Brabus	02/04-08/14			313 240 600 001		120	19.0	13.8	150	2500		313 176 300 113			S	--	E1	D1	L1			75
		KIT		313 240 900 113		120	20.5	13.8	150	2500		included in the KIT 313 176 300 113			S	--	E1	D1	L1			75
Mercedes Vito from chassis no. 16793 inc. 4x4, exc. Brabus Please order separately cover for bumper cutout at Mercedes dealer's.	02/04-08/14			313 382 600 001		90	20.0	13.5	150	2500		313 176 300 113			S	--	E1	D1	L1			75
		KIT		313 382 900 113		90	22.0	13.5	150	2500		included in the KIT 313 176 300 113			S	--	E1	D1	L1			75
Mercedes Vito W447 inc. 4x4 inc. Tourer inc. eVito	09/14-			313 435 600 001		90	20.0	13.8	100	2500		313 436 300 113			S	CAN	C	E2	D	L1	V	90
				313 436 600 001		90	21.0	13.8	100	2500												
Mercedes Vito W447 inc. 4x4 inc. Tourer	09/14-	KIT		313 435 900 113		90	22.0	13.8	100	2500		included in the KIT 313 436 300 113			S	CAN	C	E2	D	L1	V	90
		KIT		313 436 900 113		90	23.0	13.8	100	2500		included in the KIT 313 436 300 113			S	CAN	C	E2	D	L1	V	90
Mercedes class X inc. towball	09/17-05/20			332 353 600 001		30	30.6	17.2	190	3500		332 354 300 113			S	FRE	--	E2	D1	L1	H	90
		KIT		332 337 900 113		30	32.0	17.2	190	3500		included in the KIT 332 354 300 113			S	FRE	--	E2	D1	L1	H	90





















Mercedes-Benz

Mitsubishi

Mitsubishi Outlander exc. PHEV Hybrid	09/12-03/22			340 098 600 001		90	25.0	11.0	100	2000		340 099 300 113	PHEV = 300210300113	S	A	--	E2	D	L	V	75
		KIT		340 098 900 113		90	27.0	11.0	100	2000		included in the KIT 340 099 300 113	PHEV = 300210300113	S	A	--	E2	D	L	V	75
Mitsubishi Outlander	09/12-03/22			340 099 600 001		90	25.0	11.0	100	2000		340 099 300 113	PHEV = 300210300113	S	A	--	E2	D	L	V	75
		KIT		340 099 900 113		90	27.0	11.0	100	2000		included in the KIT 340 099 300 113	PHEV = 300210300113	S	A	--	E2	D	L	V	75























Nissan

Nissan Interstar Van X62B front wheel drive inc. towball	11/21-		316 318 600 001			60	19.3	14.3	100	2500		316 300 300 113		11/21- for vehicles without central plug connection	S	FRE	--	E2	D1	L1	H	45
Nissan Interstar Van X62B front wheel drive inc. towball for vehicles without central plug connection	11/21-	KIT 	316 318 900 113			60	21.0	14.3	100	2500		included in the KIT 316 300 300 113		11/21- for vehicles without central plug connection	S	FRE	--	E2	D1	L1	H	45
Nissan Interstar Chassis Cab X62B front + rear wheel drive inc. towball not for vehicles with double tires	11/21-		316 347 600 001			60	16.5	13.7	85	2300												
Nissan Juke 2 WD exc. Nismo	10/10-07/19		332 304 600 001			60	25.0	8.5	75	1500		332 305 300 113		-07/19	S	A	--	E1	D1	L1	V	60
		KIT 	332 304 900 113			60	27.0	8.5	75	1500		included in the KIT 332 305 300 113		-07/19	S	A	--	E1	D1	L1	V	60
Nissan Juke (F16)	08/19-		332 367 600 001			60		7.5	85	1350		316 482 300 113			S	A	C1	E2	D	L1	V	60
		KIT 	332 367 900 113			60		7.5	85	1350		included in the KIT 316 482 300 113			S	A	C1	E2	D	L1	V	60
Nissan Kubistar	01/02-12/09		316 201 600 001			60	12.0	7.6	75	1320		316 205 300 113		only for models with acoustical sensor	S	A	--	--	D1	--	H	45
		KIT 	316 201 900 113			60	14.0	7.6	75	1320		included in the KIT 316 205 300 113		only for models with acoustical sensor	S	A	--	--	D1	--	H	45
Nissan Kubistar 4x4	01/02-12/09		316 205 600 001			60	12.0	7.6	75	1320		316 205 300 113		only for models with acoustical sensor	S	A	--	--	D1	--	H	45
Nissan NV 400 box/estate X62 front wheel drive inc. towball	03/10-10/21		316 318 600 001			60	19.3	14.3	100	2500		316 300 300 107		for vehicles without central plug connection	S	FRE	--	E2	--	--	H	45
												316 300 300 113		for vehicles without central plug connection	S	FRE	--	E2	D1	L1	H	45
												316 318 300 113		for vehicles with central plug connection	S	FRE	--	E2	D1	L1	H	15



























Nissan NV 400 box/estate X62 front wheel drive inc. towball for vehicles without central plug connection	03/10-10/21	KIT		316 318 900 113			60	21.0	14.3	100	2500			included in the KIT 316 300 300 113		for vehicles without central plug connection	S	FRE	--	E2	D1	L1	H	45
Nissan NV 400 platform X62 front + rear wheel drive inc. towball not for vehicles with double tires	07/10-10/21			316 347 600 001			60	16.5	13.7	85	2300			300 201 300 113 316 319 300 113			--	A	--	E1	D1	--	V	
Nissan Navara D23 inc. towball	11/15-			332 353 600 001			30	30.6	17.2	190	3500			332 354 300 113		11/15-	S	FRE	--	E2	D1	L1	H	90
		KIT		332 337 900 113			30	32.0	17.2	190	3500			included in the KIT 332 354 300 113		11/15-	S	FRE	--	E2	D1	L1	H	90
Nissan Navara D40 inc. towball	10/04-10/15			332 353 600 001			30	30.6	17.2	190	3500			300 052 300 113		10/04-10/15	--	FRE	--	E1	D1	--	V	
Nissan Primastar X83 inc. towball	07/01-01/16			314 364 600 001	→		60	21.0	12.3	85	2100			314 860 300 113 314 870 300 113		08/06-03/10 03/10-	S S	FRE FRE	-- --	-- --	D1 D1	L1 L1	H H	60 60
Nissan Primastar X83 inc. towball	08/06-03/10	KIT		314 364 900 113			60	23.0	12.3	85	2100			included in the KIT 314 860 300 113		08/06-03/10	S	FRE	--	--	D1	L1	H	60
Nissan Primastar X83 inc. towball	03/10-09/14	KIT		314 870 900 113			60	23.0	12.3	85	2100			included in the KIT 314 870 300 113		03/10-	S	FRE	--	--	D1	L1	H	60
Nissan Pulsar exc. AdBlue models	09/14-06/18			332 329 600 001			60	22.5	7.4	75	1200													
Nissan Qashqai III J12	04/21-			332 368 600 001			90	20.7	11.5	100	2100			332 369 300 113		04/21-	S	FRE	--	E2	D1	L1	H	45
				332 369 600 001			90	21.0	11.5	100	2100													
		KIT		332 368 900 113			90	22.7	11.5	100	2100			included in the KIT 332 369 300 113		04/21-	S	FRE	--	E2	D1	L1	H	45
		KIT		332 369 900 113			90	23.0	11.5	100	2100			included in the KIT 332 369 300 113		04/21-	S	FRE	--	E2	D1	L1	H	45





























Nissan

Peugeot

Peugeot 2008	06/13-07/19		315 189 600 001			120	18.0	6.7	55	1150		315 185 300 113	-07/19	S	CAN	C	E	D	L1	V	60
			315 190 600 001			120	21.0	6.7	55	1150											
	KIT		315 189 900 113			120	18.0	6.7	55	1150		included in the KIT 315 185 300 113	-07/19	S	CAN	C	E	D	L1	V	60
	KIT		315 190 900 113			120	21.0	6.7	55	1150		included in the KIT 315 185 300 113	-07/19	S	CAN	C	E	D	L1	V	60
Peugeot 2008 II exc. e-2008	08/19-		315 275 600 001			90	22.3	7.8	95	1200		314 596 300 113	without preliminary setup, exc. e-2008	S	CAN	C	E2	D1	L1	V	75
			315 269 600 001			60	26.0	7.8	95	1200											
Peugeot 2008 II without preliminary setup exc. e-2008	08/19-	KIT		315 275 900 113			90	24.0	7.8	95	1200	included in the KIT 314 596 300 113	without preliminary setup, exc. e-2008	S	CAN	C	E2	D1	L1	V	75
		KIT		315 269 900 113			60	27.7	7.8	95	1200	included in the KIT 314 596 300 113									
Peugeot 206 XS, Gti, CC, RC 99- XR/XT 04/03- 206+ 09- exc. SW	08/98-12/12		315 170 600 001			90	16.0	6.8	50	1200		300 072 300 107		--	FRE	--	--	--	--	V	
												300 072 300 113		--	FRE	--	--	D1	L1	V	
Peugeot 207 inc. 207 cc convertible, inc. 207 RC - 175 HP, inc. 207 van type WG, inc. Sport	04/06-12/15		315 113 600 001			75	16.5	6.7	60	1200		304 402 300 107		S	CAN	C1	E	--	--	V	105
												304 402 300 113		S	CAN	C1	E	D	L1	V	105
		KIT		315 113 900 113			75	18.5	6.7	60	1200		included in the KIT 304 402 300 113		S	CAN	C1	E	D	L1	V
Peugeot 207 SW / Estate exc. Outdoor exc. RC (double tube exhaust)	06/07-10/13		315 118 600 001			120	17.5	6.4	46	1150		304 402 300 107		S	CAN	C1	E	--	--	V	105
												304 402 300 113		S	CAN	C1	E	D	L1	V	105
		KIT		315 118 900 113			120	19.5	6.4	46	1150		included in the KIT 304 402 300 113		S	CAN	C1	E	D	L1	V





























Peugeot



























Peugeot 3008 II Hybrid only Plugin-Hybrid				314 599 600 001		90	26.7	8.1	95	1270		315 229 300 113	10/19-	S	CAN	C	E	D	L1	V	75
Peugeot 308 II Hatchback T9 exc. GTI inc. AdBlue	09/13-08/17	KIT		304 151 900 113		90	21.0	9.5	75	1750		included in the KIT 315 196 300 113	-08/17	S	CAN	C	E2	D	L1	V	75
Peugeot 308 II Hatchback T9 exc. GT exc. GTI inc. AdBlue	09/13-08/17	KIT		304 152 900 113		90	24.0	9.5	75	1750		included in the KIT 315 196 300 113	-08/17	S	CAN	C	E2	D	L1	V	75
Peugeot 308 II Hatchback T9 exc. GT, GTI & GT-Line inc. AdBlue	09/13-06/21			304 151 600 001		90	21.0	9.5	75	1750		315 196 300 113	-08/17	S	CAN	C	E2	D	L1	V	75
				304 152 600 001		90	24.0	9.5	75	1750		315 252 300 113	09/17-06/21 inc. WLC 2.0	S	CAN	C	E	D	L1	V	75
Peugeot 308 II Hatchback T9 exc. GT, GTI & GT-Line inc. AdBlue	09/17-06/21	KIT		315 252 900 113		90	22.9	9.5	75	1750		included in the KIT 315 252 300 113	09/17-06/21 inc. WLC 2.0	S	CAN	C	E	D	L1	V	75
Peugeot 308 II Hatchback T9 exc. GT exc. GTI	09/17-06/21	KIT		315 253 900 113		90	27.4	9.5	75	1750		included in the KIT 315 252 300 113	09/17-06/21 inc. WLC 2.0	S	CAN	C	E	D	L1	V	75
Peugeot 308 III 5 doors F inc. Plug-in Hybrid	07/21-			314 603 600 001		90	21.7	9.2	90	1650		314 602 300 113	07/21- inc. Plug- in Hybrid	S	CAN	C	E	D	L1	H	75
Peugeot 308 III 5 doors F inc. Plug-in Hybrid	07/21-	KIT		314 603 900 113		90	24.2	9.2	90	1650		included in the KIT 314 602 300 113	07/21- inc. Plug- in Hybrid	S	CAN	C	E	D	L1	H	75
Peugeot 308 III sw F inc. Plugin-Hybrid	07/21-			314 604 600 001		90	20.0	9.2	108	1650		314 602 300 113	07/21- inc. Plug- in Hybrid	S	CAN	C	E	D	L1	H	75
				314 605 600 001		90	22.0	9.2	112	1650											
		KIT		314 604 900 113		90	22.0	9.2	108	1650		included in the KIT 314 602 300 113	07/21- inc. Plug- in Hybrid	S	CAN	C	E	D	L1	H	75
		KIT		314 605 900 113		90	24.0	9.2	108	1650		included in the KIT 314 602 300 113	07/21- inc. Plug- in Hybrid	S	CAN	C	E	D	L1	H	75

Peugeot 308 SW exc. GT inc. AdBlue	05/14-08/17	KIT		304 151 900 113		90	21.0	9.5	75	1750		included in the KIT 315 196 300 113	-08/17	S	CAN	C	E2	D	L1	V	75
		KIT		304 152 900 113		90	24.0	9.5	75	1750		included in the KIT 315 196 300 113	-08/17	S	CAN	C	E2	D	L1	V	75
Peugeot 308 SW exc. GT & GT-Line inc. AdBlue	05/14-02/18			304 151 600 001		90	21.0	9.5	75	1750		315 196 300 113	-08/17	S	CAN	C	E2	D	L1	V	75
				304 152 600 001		90	24.0	9.5	75	1750		315 252 300 113	09/17-02/18 inc. WLC 2.0	S	CAN	C	E	D	L1	V	75
Peugeot 308 SW exc. GT & GT-Line inc. AdBlue	09/17-02/18	KIT		315 252 900 113		90	22.9	9.5	75	1750		included in the KIT 315 252 300 113	09/17-02/18 inc. WLC 2.0	S	CAN	C	E	D	L1	V	75
Peugeot 308 SW exc. GT	09/17-02/18	KIT		315 253 900 113		90	27.4	9.5	75	1750		included in the KIT 315 252 300 113	09/17-02/18 inc. WLC 2.0	S	CAN	C	E	D	L1	V	75
Peugeot 4007	09/07-12/12			340 094 600 001		90	27.0	10.9	100	2000		340 075 300 113		S	FRE	--	E	D	L	H	75
		KIT		340 094 900 113		90	29.0	10.9	100	2000		included in the KIT 340 075 300 113		S	FRE	--	E	D	L	H	75
Peugeot 4008	03/12-12/15			340 092 600 001		90	22.0	8.5	70	1400		340 093 300 113		S	A	--	--	D	L	H	60
				340 093 600 001		90	24.0	8.5	70	1400					S	A	--	--	D	L	H
		KIT		340 092 900 113		90	24.0	8.5	70	1400		included in the KIT 340 093 300 113		S	A	--	--	D	L	H	60
		KIT		340 093 900 113		90	26.0	8.5	70	1400		included in the KIT 340 093 300 113		S	A	--	--	D	L	H	60
Peugeot 407 Estate / SW	05/04-07/08	KIT		315 104 900 113		90	29.0	10.4	75	1900		included in the KIT 304 401 300 113	-07/08 ->OPR11557	S	CAN	C1	E	D	L1	V	105
		KIT		315 105 900 113		90	31.4	10.4	75	1900		included in the KIT 304 401 300 113	-07/08 ->OPR11557	S	CAN	C1	E	D	L1	V	105

Peugeot









Peugeot







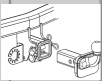



Peugeot 407 Estate / SW	05/04-02/11			304 133 600 001		90	23.0	10.4	75	1900	304 401 300 113		-07/08 ->OPR11557	S	CAN	C1	E	D	L1	V	105
				304 135 600 001		90	25.4	10.4	75	1900											
Peugeot 407 Saloon	03/04-03/08			304 135 600 001		90	25.4	10.4	75	1900	304 401 300 113		-07/08 ->OPR11557	S	CAN	C1	E	D	L1	V	105
			KIT		315 105 900 113		90	31.4	10.4	75											
Peugeot 5008 exc. vehicles with AD-Blue tank	09/09-12/16			315 177 600 001		120	21.0	10.0	75	1550	304 400 300 113		-12/11	S	CAN	C1	E	D	L1	H	105
				315 178 600 001		90	22.5	9.7	80	1700											
Peugeot 5008 exc. vehicles with Ad-Blue tank	01/12-03/14	KIT		315 177 900 113		120	23.0	10.0	75	1550	included in the KIT 315 109 300 113		01/12-03/14	S	CAN	C	E	D	L1	V	105
				315 178 900 113		90	24.5	9.7	80	1700											
Peugeot 5008	12/16-			314 585 600 001			20.0	9.9	72	1800	315 229 300 113		12/16- inc. WLC 2.0	S	CAN	C	E	D	L1	V	75
				314 586 600 001		60	21.6	9.9	72	1800											
		KIT		314 585 900 113		60	23.0	9.9	72	1800	included in the KIT 315 229 300 113	12/16- inc. WLC 2.0	S	CAN	C	E	D	L1	V	75	
		KIT		314 586 900 113		60	24.6	9.9	72	1800	included in the KIT 315 229 300 113	12/16- inc. WLC 2.0	S	CAN	C	E	D	L1	V	75	
Peugeot 508 II exc. GT & PSE exc. Plugin Hybrid	09/18-			315 261 600 001		60	26.6	9.6	75	1800	315 228 300 113		09/18- without preliminary setup inc. WLC 2.0	S	CAN	C	E	D1	L1	V	75
				315 262 600 001		60	28.1	9.6	75	1800											

Peugeot 508 II without preliminary setup exc. GT & PSE exc. Plugin Hybrid	09/18-	KIT		315 261 900 113		60	28.3	9.6	75	1800		included in the KIT 315 228 300 113	09/18- without preliminary setup inc. WLC 2.0	S	CAN	C	E	D1	L1	V	75	
		KIT		315 262 900 113		60	29.9	9.6	75	1800		included in the KIT 315 228 300 113	09/18- without preliminary setup inc. WLC 2.0	S	CAN	C	E	D1	L1	V	75	
Peugeot 508 II sw exc. GT & PSE exc. Plugin Hybrid	12/18-			315 261 600 001		60	26.6	9.6	75	1800		315 228 300 113	12/18- without preliminary setup inc. WLC 2.0	S	CAN	C	E	D1	L1	V	75	
				315 262 600 001		60	28.1	9.6	75	1800												
		KIT		315 262 900 113		60	29.9	9.6	75	1800		included in the KIT 315 228 300 113	12/18- without preliminary setup inc. WLC 2.0	S	CAN	C	E	D1	L1	V	75	
Peugeot 508 II sw without preliminary setup exc. GT & PSE exc. Plugin Hybrid	12/18-	KIT		315 261 900 113		60	28.3	9.6	75	1800		included in the KIT 315 228 300 113	12/18- without preliminary setup inc. WLC 2.0	S	CAN	C	E	D1	L1	V	75	
Peugeot 508 Estate exc. GT exc. RXH	03/11-08/18			315 180 600 001		90	20.5	10.2	75	1900												
				315 182 600 001		90	20.5	10.2	75	1900												
Peugeot 508 Saloon exc. GT/twin exhaust models	03/11-08/18			315 175 600 001		90	20.5	10.2	75	1900												
Peugeot Bipper + Tepee exc. vehicles with gas drive	02/08-07/18			306 349 600 001		150	16.5	7.5	75	1300		306 580 300 113		S	FRE	--	E	D1	L1	V	120	
		KIT		306 349 900 113		150	18.5	7.5	75	1300		included in the KIT 306 580 300 113		S	FRE	--	E	D1	L1	V	120	
Peugeot Bipper + Tepee inc. towball exc. vehicles with gas drive	02/08-07/18			306 351 600 001		150	17.0	7.5	75	1300		306 580 300 113		S	FRE	--	E	D1	L1	V	120	
Peugeot Boxer Van inc. towball	02/95-06/06			306 329 600 001		60	29.0	12.5	130	2000												

Peugeot

Peugeot















<p>Peugeot Boxer Van For vehicles with long superstructure L4/XL please order separately a set distance tubes to strengthen the framework, no. 906270650003. Some vehicles 03/08- do not have chassis bores. In this case it is necessary to bore them subsequent. For the mounting time will last 120 min. longer.</p>	06/06-			306 491 600 001		120	32.0	16.9	150	3000		306 510 300 113		-02/11 chassis no. 1948840	S	FRE	--	E	D1	L1	V	105
<p>Peugeot Boxer Van inc. towball For vehicles with long superstructure L4/XL please order separately a set distance tubes to strengthen the framework, no. 906270650003. Some vehicles 03/08- do not have chassis bores. In this case it is necessary to bore them subsequent. For the mounting time will last 120 min. longer.</p>	06/06-			306 490 600 001		120	32.0	16.9	150	3000		306 510 300 113		-02/11 chassis no. 1948840	S	FRE	--	E	D1	L1	V	105
<p>Peugeot Boxer Van inc. towball Some vehicles 03/08- do not have chassis bores. In this case it is necessary to bore them subsequent. For the mounting time will last 120 min. longer.</p>	06/06-			306 357 600 001	→ 	60	29.0	15.8	150	3000		306 510 300 113		-02/11 chassis no. 1948840	S	FRE	--	E	D1	L1	V	105
<p>Peugeot Boxer Van inc. towball for vehicles up to 6 m long 51 mm square holder</p>	06/06-			306 563 600 001		60	25.7	15.1	100	2500		306 510 300 113		-02/11 chassis no. 1948840	S	FRE	--	E	D1	L1	V	105
<p>Peugeot Boxer Van van / minibus For vehicles with long superstructure L4/XL please order separately a set distance tubes to strengthen the framework, no. 906270650003. Some vehicles 03/08- do not have chassis bores. In this case it is necessary to bore them subsequent. For the mounting time will last 120 min. longer.</p>	06/06-02/11	KIT		306 271 900 113		120	34.0	16.9	150	3000		included in the KIT 306 510 300 113		-02/11 chassis no. 1948840	S	FRE	--	E	D1	L1	V	105







Peugeot Boxer Van inc. towball For vehicles with long superstructure L4/XL please order separately a set distance tubes to strengthen the framework, no. 906270650003. Some vehicles 03/08- do not have chassis bores. In this case it is necessary to bore them subsequent. For the mounting time will last 120 min. longer.	06/06-02/11	KIT		306 330 900 113			120	34.0	16.9	150	3000				included in the KIT 306 510 300 113		-02/11 chassis no. 1948840	S	FRE	--	E	D1	L1	V	105
Peugeot Boxer Van For vehicles with long superstructure L4/XL please order separately a set distance tubes to strengthen the framework, no. 906270650003. Some vehicles 03/08- do not have chassis bores. In this case it is necessary to bore them subsequent. For the mounting time will last 120 min. longer.	02/11-	KIT		306 491 900 113			120	32.8	16.9	150	3000				included in the KIT 306 553 300 113		02/11- from chassis no. 1948841	S	FRE	--	E	D1	L1	V	105
Peugeot Boxer Van inc. towball Some vehicles 03/08- do not have chassis bores. In this case it is necessary to bore them subsequent. For the mounting time will last 120 min. longer.	02/11-	KIT		306 553 900 113	→		>150	31.0	15.8	150	3000				included in the KIT 306 553 300 113		02/11- from chassis no. 1948841	S	FRE	--	E	D1	L1	V	105
Peugeot Boxer Van inc. towball For vehicles with long superstructure L4/XL please order separately a set distance tubes to strengthen the framework, no. 906270650003. Some vehicles 03/08- do not have chassis bores. In this case it is necessary to bore them subsequent. For the mounting time will last 120 min. longer.	02/11-	KIT		306 490 900 113			120	32.2	16.9	150	3000				included in the KIT 306 553 300 113		02/11- from chassis no. 1948841	S	FRE	--	E	D1	L1	V	105
Peugeot Boxer Chassis Cab inc. towball	02/95-06/06			306 329 600 001	→		60	29.0	12.5	130	2000			300 052 300 113 300 060 300 113		03/02- -03/02	-- --	FRE C2	-- --	E1 E1	D1 D1	-- L1	V H		45
Peugeot Boxer Chassis Cab inc. towball For vehicles with long superstructure L4/XL please order separately a set distance tubes to strengthen the framework, no. 906270650003.	06/06-			306 492 600 001			120	35.0	15.9	150	3000			306 531 300 113				S	FRE	--	E1	D	--	V	90

Peugeot Expert / Traveller inc. e-Expert / e-Traveller with preliminary setup inc. towball	11/19-	KIT		314 576 900 113			45	27.7	13.9	104	2500			included in the KIT 314 585 300 113		11/19- inc. WLC 2.0 with preliminary setup inc. e- Expert / e-Traveller	S	FRE	C	E	D	L1	H	75
Peugeot Expert / Traveller inc. e-Expert / e-Traveller with preliminary setup	11/19-	KIT		314 578 900 113			60	27.2	13.9	104	2500			included in the KIT 314 585 300 113		11/19- inc. WLC 2.0 with preliminary setup inc. e- Expert / e-Traveller	S	FRE	C	E	D	L1	H	75
Peugeot Partner Van	11/96-04/08			304 054 600 001			90	14.8	7.8	70	1350			304 054 300 113			S	FRE	--	E1	D1	--	V	75
		KIT		304 054 900 113			90	16.8	7.8	70	1350			included in the KIT 304 054 300 113			S	FRE	--	E1	D1	--	V	75
Peugeot Partner Van long superstructure + Tepee, vehicle length = 4628 mm	08-11/11	KIT		304 129 900 113			90	18.3	8.7	64	1600			included in the KIT 304 400 300 113		-11/11 -> OPR12775	S	CAN	C1	E	D	L1	H	105
Peugeot Partner Van long superstructure + Tepee, vehicle length = 4628 mm	08-08/18			304 129 600 001			90	16.3	8.7	64	1600			304 400 300 113		-11/11 -> OPR12775	S	CAN	C1	E	D	L1	H	105
														304 402 300 107		11/11- OPR12776->	S	CAN	C1	E	--	--	V	105
															304 402 300 113		11/11- OPR12776->	S	CAN	C1	E	D	L1	V
Peugeot Partner Van short superstructure + Tepee, vehicle length = 4380 mm	04/08-11/11	KIT		304 091 900 113			90	17.0	8.7	64	1600			included in the KIT 304 400 300 113		-11/11 -> OPR12775	S	CAN	C1	E	D	L1	H	105
		KIT		304 092 900 113			90	21.0	8.7	64	1600			included in the KIT 304 400 300 113		-11/11 -> OPR12775	S	CAN	C1	E	D	L1	H	105
Peugeot Partner Van short superstructure + Tepee, vehicle length = 4380 mm exc. Partner Electric	04/08-08/18			304 091 600 001			90	15.0	8.7	64	1600			304 400 300 113		-11/11 -> OPR12775	S	CAN	C1	E	D	L1	H	105
														304 402 300 107		11/11- OPR12776->	S	CAN	C1	E	--	--	V	105
															304 402 300 113		11/11- OPR12776->	S	CAN	C1	E	D	L1	V
Peugeot Partner Van L1 inc. Rifter inc. towball	09/18-			304 118 600 001			90	17.0	8.4	64	1600			314 594 300 113			S	A	C	E	D	L	V	90

Peugeot



Peugeot















Peugeot Partner Van L1 inc. Rifter	09/18-			304 207 600 001			60	20.0	8.6	75	1500		314 594 300 113			S	A	C	E	D	L	V	90
				304 209 600 001			60	20.5	8.6	75	1500												
		KIT		304 207 900 113			60	21.2	8.6	75	1500		included in the KIT 314 594 300 113			S	A	C	E	D	L	V	90
		KIT		304 209 900 113			60	21.8	8.6	75	1500		included in the KIT 314 594 300 113			S	A	C	E	D	L	V	90
Peugeot Partner Van L2 inc. Rifter	09/18-			304 210 600 001			60	21.0	8.6	75	1500		314 594 300 113			S	A	C	E	D	L	V	90
				304 212 600 001			60	21.5	8.6	75	1500												
		KIT		304 212 900 113			60	22.8	8.6	75	1500		included in the KIT 314 594 300 113			S	A	C	E	D	L	V	90
Peugeot Partner Origin	04/08-06/18			304 054 600 001			90	14.8	7.8	70	1350		304 054 300 113			S	FRE	--	E1	D1	--	V	75
			KIT		304 054 900 113			90	16.8	7.8	70	1350		included in the KIT 304 054 300 113			S	FRE	--	E1	D1	--	V
Peugeot Rifter L1 inc. Partner	09/18-			304 207 600 001			60	20.0	8.6	75	1500		314 594 300 113		inc. WLC 2.0	S	A	C	E	D	L	V	90
				304 209 600 001			60	20.5	8.6	75	1500												
		KIT		304 207 900 113			60	21.2	8.6	75	1500		included in the KIT 314 594 300 113		inc. WLC 2.0	S	A	C	E	D	L	V	90

Peugeot Rifter L2 inc. Partner	09/18-		304 210 600 001			60	21.0	8.6	75	1500		314 594 300 113	inc. WLC 2.0	S	A	C	E	D	L	V	90	
			304 212 600 001			60	21.5	8.6	75	1500												
	KIT		304 210 900 113			60	22.2	8.6	75	1500		included in the KIT 314 594 300 113	inc. WLC 2.0	S	A	C	E	D	L	V	90	
	KIT		304 212 900 113			60	22.8	8.6	75	1500		included in the KIT 314 594 300 113	inc. WLC 2.0	S	A	C	E	D	L	V	90	
Peugeot Rifter L1 inc. Partner	09/18-		304 118 600 001			90	17.0	8.4	64	1600		314 594 300 113	inc. WLC 2.0	S	A	C	E	D	L	V	90	
Peugeot Rifter L1 inc. Partner	09/18	KIT		304 209 900 113			60	21.8	8.6	75	1500		included in the KIT 314 594 300 113	inc. WLC 2.0	S	A	C	E	D	L	V	90





















Peugeot

























Polestar

Polestar 2 P	04/19-			320 187 600 001		60	27.3	9.3	90	1500		320 187 300 113		04/19-	S	A	--	E2	D	L1	H	60	
		KIT		320 187 900 113		60	22.5	9.3	90	1500		included in the KIT 320 187 300 113		04/19-	S	A	--	E2	D	L1	H	60	

Porsche Cayenne Please order separately cover for bumper cutout at Porsche dealer' s. exc. vehicles with spare wheel on the tailgate	12/02-04/10	KIT		321 500 900 113	→ 	150	36.0	16.4	140	3500		included in the KIT 321 500 300 113	→	-04/10	S	CAN	--	E	D	L1	H	45
Porsche Cayenne	12/02-10/17			321 735 600 001		150	33.5	16.4	140	3500		321 500 300 113	→	-04/10	S	CAN	--	E	D	L1	H	45
												321 765 300 113		04/10-10/17	S	CAN	C	E	D	L1	V	180
Porsche Cayenne models 12/02-04/10: Please order separately cover for bumper cutout at Porsche dealer' s. exc. vehicles with spare wheel on the tailgate	12/02-10/17			321 736 600 001		150	34.0	16.4	140	3500		321 500 300 113	→	-04/10	S	CAN	--	E	D	L1	H	45
												321 765 300 113		04/10-10/17	S	CAN	C	E	D	L1	V	180
Porsche Cayenne	04/10-10/17	KIT		321 736 900 113		150	36.0	16.4	140	3500		included in the KIT 321 765 300 113		04/10-10/17	S	CAN	C	E	D	L1	V	180
Porsche Cayenne (9YA)	11/17-			322 064 600 001		60	27.0	15.7	191	3500												
Porsche Macan	04/14-			327 068 600 001		90	21.0	12.1	100	2400		327 068 300 113			S	CAN	C	E	D	L1	H	30
		KIT		327 068 900 113		90	23.0	12.1	100	2400		included in the KIT 327 068 300 113			S	CAN	C	E	D	L1	H	30

















Renault





















Renault Alaskan inc. towball	09/17-		332 353 600 001			30	30.6	17.2	190	3500		332 354 300 113			S	FRE	--	E2	D1	L1	H	90
		KIT		332 337 900 113			30	32.0	17.2	190	3500		included in the KIT 332 354 300 113			S	FRE	--	E2	D1	L1	H
Renault Arkana LCM	03/21-		316 494 600 001			60	19.8	8.8	108	1500		316 493 300 113	03/21-	S	FRE	--	E	D1	L1	H	60	
			316 495 600 001			60	22.8	8.8	108	1500												
		KIT		316 494 900 113			60	21.5	8.8	108	1500		included in the KIT 316 493 300 113	03/21-	S	FRE	--	E	D1	L1	H	60
		KIT		316 495 900 113			60	24.4	8.8	108	1500		included in the KIT 316 493 300 113	03/21-	S	FRE	--	E	D1	L1	H	60
Renault Captur I	05/13-19		316 354 600 001			90	14.0	7.1	75	1200		316 337 300 113		S	A	--	E2	D1	L1	H	90	
			316 355 600 001			90	16.0	7.1	75	1200												
		KIT		316 354 900 113			90	16.0	7.1	75	1200		included in the KIT 316 337 300 113		S	A	--	E2	D1	L1	H	90
		KIT		316 355 900 113			90	18.0	7.1	75	1200		included in the KIT 316 337 300 113		S	A	--	E2	D1	L1	H	90
Renault Captur II inc. AdBlue inc. Plugin Hybrid Renault holders 82 04 269 02R and 85 04 282 73R are required for vehicles with plastic impact absorbers.	01/20-		316 486 600 001			60	24.0	9.1	106	1500		316 482 300 113			S	A	C1	E2	D	L1	V	60

Renault Captur II inc. AdBlue inc. Plugin Hybrid	01/20-		316 487 600 001		60	24.9	9.1	106	1500		316 482 300 113			S	A	C1	E2	D	L1	V	60	
		KIT		316 486 900 113		60	25.9	9.1	106	1500		included in the KIT 316 482 300 113			S	A	C1	E2	D	L1	V	60
		KIT		316 487 900 113		60	26.7	9.1	106	1500		included in the KIT 316 482 300 113			S	A	C1	E2	D	L1	V	60
Renault Clio II Phase I + II, exc. Phase IV, exc. Clio Sport V6	09/98-10/05		316 187 600 001		90	14.5	6.2	75	1200		300 072 300 113		-05/01 (Phase I)	--	FRE	--	--	D1	L1	V		
Renault Clio III BR Phase I + II exc. Clio Sport 197/201 HP exc. RS-Cup exc. GT	10/05-11/12		316 354 600 001		90	14.0	7.1	75	1200		316 252 300 113		-11/12	S	FRE	--	--	D1	L1	H	45	
			316 355 600 001		90	16.0	7.1	75	1200													
		KIT		316 251 900 113		60	15.0	7.1	75	1200		included in the KIT 316 252 300 113		-11/12	S	FRE	--	--	D1	L1	H	45
		KIT		316 252 900 113		90	17.0	7.1	75	1200		included in the KIT 316 252 300 113		-11/12	S	FRE	--	--	D1	L1	H	45
Renault Clio IV Hatchback BH exc. GT exc. Initiale	11/12-06/19		316 354 600 001		90	14.0	7.1	75	1200		316 337 300 113		-06/19	S	A	--	E2	D1	L1	H	90	
			316 355 600 001		90	16.0	7.1	75	1200													
		KIT		316 354 900 113		90	16.0	7.1	75	1200		included in the KIT 316 337 300 113		-06/19	S	A	--	E2	D1	L1	H	90
		KIT		316 355 900 113		90	18.0	7.1	75	1200		included in the KIT 316 337 300 113		-06/19	S	A	--	E2	D1	L1	H	90
Renault Clio IV Grandtour	03/13-12/20		316 336 600 001		60	15.0	7.1	75	1200		316 337 300 113			S	A	--	E2	D1	L1	H	90	
		KIT		316 336 900 113		60	17.0	7.1	75	1200		included in the KIT 316 337 300 113			S	A	--	E2	D1	L1	H	90















Renault

Renault





















Renault Clio V (BF) inc. AdBlue	06/19-			316 481 600 001		75	22.9	6.1	74	900	316 482 300 113			S	A	C1	E2	D	L1	V	60
				316 482 600 001		75	24.2	6.1	74	900											
		KIT		316 481 900 113		75	24.6	6.1	74	900	included in the KIT 316 482 300 113			S	A	C1	E2	D	L1	V	60
		KIT		316 482 900 113		75	25.9	6.1	74	900	included in the KIT 316 482 300 113			S	A	C1	E2	D	L1	V	60
Renault Espace short wheelbase	09/02-05/15			316 195 600 001		55	31.0	11.3	80	2000	300 078 300 113			--	FRE	--	--	D1	L1	V	
Renault Espace exc. AdBlue	06/15-10/19	KIT		316 387 900 113		120	29.0	11.0	80	2000	included in the KIT 316 403 300 113	06/15-10/19		S	FRE	--	E2	D1	L1	H	90
Renault Espace exc. AdBlue	06/15-04/23			316 387 600 001		120	25.0	11.0	80	2000	316 403 300 113	06/15-10/19		S	FRE	--	E2	D1	L1	H	90
Renault Express exc. vehicles with park distance control	05/21-			316 333 600 001		60	19.5	7.3	75	1200											
				316 334 600 001		60	19.5	7.3	75	1200											
Renault Grand Kangoo 7 seats exc. AdBlue	02/08-04/13	KIT		316 268 900 113		60	25.0	8.2	75	1350	included in the KIT 316 440 300 113		-04/13 exc. vehicles with start-/stop automatic	S	FRE	--	E2	D1	L1	H	45
		KIT		316 269 900 113		60	25.0	8.2	75	1350	included in the KIT 316 440 300 113		-04/13 exc. vehicles with start-/stop automatic	S	FRE	--	E2	D1	L1	H	45
Renault Grand Kangoo 7 seats exc. AdBlue	02/08-04/21			316 268 600 001		60	23.0	8.2	75	1350	316 353 300 113		05/13-	S	FRE	--		D1	L1	H	60
				316 269 600 001		60	23.0	8.2	75	1350	316 440 300 113		-04/13 exc. vehicles with start-/stop automatic	S	FRE	--	E2	D1	L1	H	45

Renault Grand Kangoo 7 seats exc. AdBlue	05/13-04/21	KIT		316 352 900 113			60	25.0	8.2	75	1350		included in the KIT 316 353 300 113	05/13-	S	FRE	--		D1	L1	H	60	
		KIT		316 353 900 113			60	25.0	8.2	75	1350		included in the KIT 316 353 300 113	05/13-	S	FRE	--		D1	L1	H	60	
Renault Grand Modus F exc. vehicles with rear end carrier system Velofix	01/08-12/12			316 354 600 001			90	14.0	7.1	75	1200		300 210 300 113		--	A	--	E1	D1	L1	V	90	
				316 355 600 001			90	16.0	7.1	75	1200												
Renault Grand Scenic	04/09-08/16			316 297 600 001			90	21.4	8.2	75	1300		316 297 300 113		S	A	--	--	D1	L1	H	60	
		KIT		316 297 900 113			90	23.4	8.2	75	1300		included in the KIT 316 297 300 113		S	A	--	--	D1	L1	H	60	
Renault Grand Scenic	12/16-			316 431 600 001				25.3	10.2	75	1850		316 368 300 113		S	FRE	--	E	D1	L1	H	90	
				316 432 600 001			60	27.3	10.2	75	1850												
		KIT		316 431 900 113				28.0	10.2	75	1850		included in the KIT 316 368 300 113		S	FRE	--	E	D1	L1	H	90	
		KIT		316 432 900 113			60	29.5	10.2	75	1850		included in the KIT 316 368 300 113		S	FRE	--	E	D1	L1	H	90	
Renault Kadjar	06/15-12/18			316 390 600 001			120	21.0	9.8	80	1800		316 404 300 113	-12/18	S	FRE	--	E2	D1	L1	H	90	
				316 391 600 001			120	22.0	9.8	80	1800												
		KIT		316 390 900 113			120	22.0	9.8	80	1800		included in the KIT 316 404 300 113	-12/18	S	FRE	--	E2	D1	L1	H	90	
		KIT		316 391 900 113			120	23.0	9.8	80	1800		included in the KIT 316 404 300 113	-12/18	S	FRE	--	E2	D1	L1	H	90	

Renault















Renault Kangoo III exc. vehicles with towbar preparation exc. vehicles with spare wheel	07/21-			316 492 600 001		90	26.7	9.4	114	1500		316 493 300 113	07/21-	S	FRE	--	E	D1	L1	H	60
Renault Kangoo III FJ/KJ without preliminary setup for vehicles without spare wheel	07/21-	KIT		316 492 900 113		90	28.3	9.4	114	1500		included in the KIT 316 493 300 113	07/21-	S	FRE	--	E	D1	L1	H	60
Renault Koleos inc. Phase I + II 09/11-	09/08-12/15			316 226 600 001		40	21.7	10.5	100	2000											
				316 227 600 001		40	23.8	10.5	100	2000											
Renault Koleos II From facelift 2019, the AdBlue tank must be dismantled.	04/17-			316 454 600 001		75	27.7	10.8	80	2000		316 437 300 113	-09/20	S	FRE	C	E2	D1	L1	H	75
Renault Koleos II From facelift 2019, the AdBlue tank must be dismantled.	04/17-09/20	KIT		316 454 900 113		75	28.2	10.8	80	2000		included in the KIT 316 437 300 113	-09/20	S	FRE	C	E2	D1	L1	H	75
Renault Master Van X62B front wheel drive inc. towball	03/10-			316 318 600 001		60	19.3	14.3	100	2500		316 300 300 107	for vehicles without central plug connection	S	FRE	--	E2	--	--	H	45
											316 300 300 113	for vehicles without central plug connection	S	FRE	--	E2	D1	L1	H	45	
											316 318 300 113	for vehicles with central plug connection	S	FRE	--	E2	D1	L1	H	15	
Renault Master Van X62B front wheel drive inc. towball for vehicles without central plug connection	03/10-	KIT		316 318 900 113		60	21.0	14.3	100	2500		included in the KIT 316 300 300 113	for vehicles without central plug connection	S	FRE	--	E2	D1	L1	H	45
Renault Master Chassis Cab Front + rear wheel drive inc. ball plate not for vehicles with double tires	07/10-			316 347 600 001		60	16.5	13.7	85	2300		316 319 300 113	for vehicles with preparation	S	FRE	--	E1	D1	--	H	15
Renault Mégane 5 doors exc. GT/GT-Line	02/16-			316 448 600 001		60	27.3	9.6	75	1850		316 359 300 107	-04/20	S	FRE	--	E2	--	--	V	90
											316 359 300 113	-04/20	S	FRE	--	E2	D1	L1	V	90	

Renault

























Renault Mégane IV Grandtour exc. E-Tech	04/16-		316 388 600 001		60	29.2	10.2	75	1850	316 359 300 107	-04/20	S	FRE	--	E2	--	--	V	90				
						316 389 600 001		60	30.0		10.2	75	1850	316 359 300 113	-04/20	S	FRE	--	E2	D1	L1	V	90
								316 447 300 113	05/20-		S	FRE	--	E2	D1	L1	H	60					
Renault Mégane cc Convertible	04/10-08/15		316 320 600 001		120	22.1	6.1	75	750	300 210 300 113		--	A	--	E1	D1	L1	V	90				
Renault Modus II exc. vehicles with rear end carrier system Velofix	01/08-12/12		316 283 600 001		60	18.0	5.8	75	900	300 210 300 113		--	A	--	E1	D1	L1	V	90				
Renault Scenic exc. Grand Scenic, exc. Conquest	07/03-06/09		316 352 600 001		120	18.0	8.7	75	1500	316 207 300 113		S	FRE	--	E2	D1		H	45				
						316 363 600 001	120	21.0	8.7											75	1500		
		KIT		316 206 900 113		90	21.0	8.1	75	1350	included in the KIT 316 207 300 113		S	FRE	--	E2	D1		H	45			
			KIT		316 207 900 113		90	22.0	8.1	75	1350	included in the KIT 316 207 300 113		S	FRE	--	E2	D1		H	45		
Renault Scenic inc. Scenic Xmod	06/09-08/16		316 352 600 001		120	18.0	8.7	75	1500	316 294 300 107		-08/16	S	A	--	--	--	--	H	60			
						316 363 600 001	120	21.0	8.7												75	1500	316 294 300 113
		KIT		316 292 900 113		90	20.3	7.9	75	1300	included in the KIT 316 294 300 113		S	A	--	--	D1	L1	H	60			
			KIT		316 294 900 113		90	24.4	7.9	75	1300	included in the KIT 316 294 300 113		S	A	--	--	D1	L1	H	60		
Renault Talisman Grandtour exc. vehicles with tailgate that opens by sensor (foot sensor)	04/16--05/20	KIT		316 407 900 113		90	27.4	10.0	75	1850	included in the KIT 316 407 300 113	-05/20	S	FRE	--	E2	D1	L1	H	75			
Renault Talisman Grandtour exc. vehicles with tailgate that opens by sensor (foot sensor)	04/16-02/22			316 407 600 001		75	24.2	10.1	75	1850	316 407 300 113	-05/20	S	FRE	--	E2	D1	L1	H	75			

















Renault

Renault

Renault Talisman Saloon exc. vehicles with tailgate that opens by sensor (foot sensor)	04/16--05/20	KIT		316 407 900 113		90	27.4	10.0	75	1850		included in the KIT 316 407 300 113	-05/20	S	FRE	--	E2	D1	L1	H	75
Renault Talisman Saloon exc. vehicles with tailgate that opens by sensor (foot sensor)	04/16-02/22			316 407 600 001		75	24.2	10.1	75	1850		316 407 300 113	-05/20	S	FRE	--	E2	D1	L1	H	75
Renault Trafic Van inc. towball	05/01-09/14			314 364 600 001	 	60	21.0	12.3	85	2100		314 860 300 113 314 870 300 113	08/06-03/10 03/10-	S S	FRE FRE	-- --	-- --	D1 D1	L1 L1	H H	60 60
Renault Trafic Van inc. towball	08/06-03/10	KIT		314 364 900 113		60	23.0	12.3	85	2100		included in the KIT 314 860 300 113	08/06-03/10	S	FRE	--	--	D1	L1	H	60
Renault Trafic Van inc. towball	03/10-09/14	KIT		314 870 900 113		60	23.0	12.3	85	2100		included in the KIT 314 870 300 113	03/10-	S	FRE	--	--	D1	L1	H	60
Renault Twingo exc. model "Sport" inc. Gordini R.S. (a visible cutout is necessary)	06/07-14			316 326 600 001	 	60	17.0	4.2	65	500		300 210 300 113		--	A	--	E1	D1	L1	V	90





















Seat

















Seat Alhambra thermal-insulation plate inc. inc. 4WD bumper bracket is not necessary	05/00-09/10		321 665 600 001			90	24.0	12.5	100	2500		321 458 300 113			S	FRE	--	E	D1	L1	H	60
		KIT		321 665 900 113			90	26.0	12.5	100	2500	included in the KIT 321 458 300 113			S	FRE	--	E	D1	L1	H	60
Seat Alhambra	10/10-01/22		321 698 600 001				22.0	12.3	100	2500		321 600 300 113	-01/22		S	FRE	C	E	D	L1	V	105
		KIT		321 698 900 113				24.0	12.3	100	2500	included in the KIT 321 600 300 113		-01/22	S	FRE	C	E	D	L1	V	105
Seat Alhambra Please order separately Spoiler and cover for bumper cutout at Seat dealer's.	10/10-01/22		321 700 600 001				22.0	12.3	100	2500		321 600 300 113	-01/22		S	FRE	C	E	D	L1	V	105
		KIT		321 700 900 113				24.0	12.3	100	2500	included in the KIT 321 600 300 113		-01/22	S	FRE	C	E	D	L1	V	105
Seat Altea exc. FR	06/04-12/15		344 043 600 001			60	18.0	9.3	100	1650		344 044 300 113			S	CAN	C	E	D1	L1	V	90
Seat Altea without preliminary setup exc. FR	06/04-12/15	KIT		344 043 900 113		60	20.0	9.3	100	1650		included in the KIT 344 044 300 113			S	CAN	C	E	D1	L1	V	90
Seat Altea inc. FR Please order separately cover for bumper cutout at Seat dealer' s, no. 5P0 803 595.	06/04-12/15		344 044 600 001			60	18.0	9.3	100	1650		344 044 300 113			S	CAN	C	E	D1	L1	V	90
		KIT		344 044 900 113			60	19.5	9.3	100	1650	included in the KIT 344 044 300 113			S	CAN	C	E	D1	L1	V	90
Seat Altea XL + Freetrack	10/06-12/15		344 043 600 001			60	18.0	9.3	100	1650		344 044 300 113	without preliminary setup		S	CAN	C	E	D1	L1	V	90
Seat Altea XL + Freetrack without preliminary setup	10/06-12/15	KIT		344 043 900 113		60	20.0	9.3	100	1650	included in the KIT 344 044 300 113		without preliminary setup		S	CAN	C	E	D1	L1	V	90
Seat Altea XL + Freetrack fitting cover for bumper cutout not available	10/06-12/15		344 048 600 001			60	17.5	9.3	100	1650		344 044 300 113	without preliminary setup		S	CAN	C	E	D1	L1	V	90

Seat Altea XL + Freetrack without preliminary setup fitting cover for bumper cutout not available	10/06-12/15	KIT		344 048 900 113		60	19.5	9.3	100	1650		included in the KIT 344 044 300 113	without preliminary setup	S	CAN	C	E	D1	L1	V	90	
Seat Arona FR: visible cutout exc. TGI	11/17-08/21			344 111 600 001		70	21.6	7.1	55	1200		344 110 300 113		S	CAN	C	E	D	L	V	60	
Seat Arona KJ exc. TGI	11/17-08/21			344 110 600 001		70	20.4	7.1	55	1200		344 110 300 113		S	CAN	C	E	D	L	V	60	
		KIT		344 110 900 113		70	21.6	7.1	55	1200		included in the KIT 344 110 300 113		S	CAN	C	E	D	L	V	60	
		KIT		344 111 900 113		70	22.8	7.1	55	1200		included in the KIT 344 110 300 113		S	CAN	C	E	D	L	V	60	
Seat Arona FR KJ exc. TGI	11/17-08/21			344 110 600 001		70	20.4	7.1	55	1200		344 110 300 113		S	CAN	C	E	D	L	V	60	
Seat Arona FR KJ exc. TGI	11/17-08/21			344 111 600 001		70	21.6	7.1	55	1200		344 110 300 113		S	CAN	C	E	D	L	V	60	
		KIT		344 110 900 113		70	21.6	7.1	55	1200		included in the KIT 344 110 300 113		S	CAN	C	E	D	L	V	60	
		KIT		344 111 900 113		70	22.8	7.1	55	1200		included in the KIT 344 110 300 113		S	CAN	C	E	D	L	V	60	
Seat Ateca KH7 inc. FR	09/16-			344 124 600 001		60	17.7	12.3	150	2500		305 407 300 113	with preliminary setup	S	CAN	C	E	D	L	H	30	
												305 408 300 107	→ without preliminary setup	S	CAN	C	E	--	--	V	60	
													305 408 300 113	without preliminary setup	S	CAN	C	E	D	L	V	60
													305 438 300 113	inc. WLC 2.0 without preliminary setup	S	CAN	C	E	D	L1	V	90
													344 095 300 113	09/16- KH7 for vehicles with preparationg and integrated trailer control unit, for PR no. 1M7	S	CAN	--	E	D	L	H	30

Seat







Seat











Seat Ateca KH7 without preliminary setup inc. FR	09/16-	KIT		344 121 900 113		60	16.0	12.3	150	2500		included in the KIT 305 438 300 113		inc. WLC 2.0 without preliminary setup	S	CAN	C	E	D	L1	V	90	
		KIT		344 124 900 113		60	19.6	12.3	150	2500		included in the KIT 305 438 300 113		inc. WLC 2.0 without preliminary setup	S	CAN	C	E	D	L1	V	90	
Seat Ateca KH7 inc. FR	09/16-			344 121 600 001		60	14.0	12.3	150	2500		305 407 300 113		with preliminary setup	S	CAN	C	E	D	L	H	30	
												305 408 300 107	→	without preliminary setup	S	CAN	C	E	--	--	V	60	
													305 408 300 113		without preliminary setup	S	CAN	C	E	D	L	V	60
													305 438 300 113		inc. WLC 2.0 without preliminary setup	S	CAN	C	E	D	L1	V	90
												344 095 300 113		09/16- KH7 for vehicles with preparationg and integrated trailer control unit, for PR no. 1M7	S	CAN	--	E	D	L	H	30	
Seat Ateca KH7 with preliminary setup inc. FR	09/16-	KIT		344 071 900 113		60	15.5	12.3	150	2500		included in the KIT 305 407 300 113		with preliminary setup	S	CAN	C	E	D	L	H	30	
		KIT		344 072 900 113		60	19.2	12.3	150	2500		included in the KIT 305 407 300 113		with preliminary setup	S	CAN	C	E	D	L	H	30	
Seat Exeo Saloon and ST/ Estate	03/09-12/13			344 074 600 001		120	20.0	10.6	100	2000		305 210 300 113			S	CAN	C	E	D1	L1	V	105	
		KIT		344 054 900 113		120	22.0	10.6	100	2000		included in the KIT 305 210 300 113			S	CAN	C	E	D1	L1	V	105	
Seat Ibiza ST Estate / 3/5 doors Please order separately cover for bumper cutout at Seat dealer's.	07/08--07/15	KIT		344 060 900 113		90	24.0	7.7	75	1400		included in the KIT 317 420 300 113		-07/15	S	CAN	C	E	D1	L1	V	105	
Seat Ibiza ST Estate / 3/5 doors	07/08-06/17			344 059 600 001		90	17.5	8.3	75	1400		317 114 300 113		07/15-06/17	S	CAN	C	E	D1	L1	V	90	
												317 420 300 113		-07/15	S	CAN	C	E	D1	L1	V	105	
Seat Ibiza ST Estate / 3/5 doors Please order separately cover for bumper cutout at Seat dealer's.	07/08-06/17			344 079 600 001		90	22.0	7.7	75	1400		317 114 300 113		07/15-06/17	S	CAN	C	E	D1	L1	V	90	
												317 420 300 113		-07/15	S	CAN	C	E	D1	L1	V	105	

Seat Ibiza ST Estate / 3/5 doors	07/15-06/17	KIT		344 059 900 113		90	18.5	8.3	75	1400		included in the KIT 317 114 300 113	07/15-06/17	S	CAN	C	E	D1	L1	V	90
Seat Ibiza ST Estate / 3/5 doors Please order separately cover for bumper cutout at Seat dealer's.	07/15-06/17	KIT		344 079 900 113		90	19.5	7.7	75	1400		included in the KIT 317 114 300 113	07/15-06/17	S	CAN	C	E	D1	L1	V	90
Seat Ibiza V (KJ1) exc. TGI	02/17-			344 122 600 001		60	17.0	7.5	91	1270		344 110 300 113		S	CAN	C	E	D	L	V	60
		KIT		344 122 900 113		60	19.0	7.5	91	1270		included in the KIT 344 110 300 113		S	CAN	C	E	D	L	V	60
Seat Ibiza V (KJ1) exc. TGI	02/17-			344 123 600 001		60	18.0	7.5	91	1270		344 110 300 113		S	CAN	C	E	D	L	V	60
		KIT		344 123 900 113		60	20.0	7.5	91	1270		included in the KIT 344 110 300 113		S	CAN	C	E	D	L	V	60
Seat Leon 1M1	11/99-06/06			305 223 600 001		120	16.8	8.9	75	1650											
Seat Leon exc. FR + FRV Formula Race, exc. Cupra	09/05-12/12			344 043 600 001		60	18.0	9.3	100	1650		321 600 300 113		S	FRE	C	E	D	L1	V	105
Seat Leon inc. FR exc. FRV Formula Race, Cupra Please order separately cover for bumper cutout at Seat dealer' s, no. -05/09: 5P0 803 595, 05/09-: 1P0 092 595.	09/05-12/12			344 044 600 001		60	18.0	9.3	100	1650		321 600 300 113		S	FRE	C	E	D	L1	V	105
Seat Leon III (5F) without preliminary setup 5 doors Seat Leon SC, 3 doors Seat Leon ST, Combi inc. FR exc. Cupra	11/12-06/14	KIT		317 131 900 113		60	21.0	10.3	85	2000		included in the KIT 305 406 300 113	-06/14 without preliminary setup	S	CAN	C	E	D	L1	V	150

Seat

















Seat

















Seat Leon III (5F) without preliminary setup 5 doors Seat Leon SC, 3 doors Seat Leon ST, Combi inc. FR exc. Cupra Please order separately cover for bumper cutout at Seat dealer's.	11/12-06/14	KIT		317 132 900 113		60	21.0	10.3	85	2000		included in the KIT 305 406 300 113		-06/14 without preliminary setup	S	CAN	C	E	D	L1	V	150
Seat Leon III (5F) 5 doors Seat Leon SC, 3 doors Seat Leon ST, Combi inc. X-Perience 06/14- inc. FR exc. Cupra	11/12-04/20			317 131 600 001		60	19.0	10.3	85	2000		305 403 300 113		-06/14 with preliminary setup	S	CAN	C	E	D	L1	H	45
												305 406 300 113		-06/14 without preliminary setup	S	CAN	C	E	D	L1	V	150
												305 407 300 113		06/14-04/20 with preliminary setup	S	CAN	C	E	D	L	H	30
												305 408 300 107	→	06/14-04/20 without preliminary setup	S	CAN	C	E	--	--	V	60
												305 408 300 113		06/14-04/20 without preliminary setup	S	CAN	C	E	D	L	V	60
												344 095 300 113		06/14-04/20 for vehicles with preparation and integrated trailer control unit	S	CAN	--	E	D	L	H	30
Seat Leon III (5F) 5 doors Seat Leon SC, 3 doors Seat Leon ST, Combi inc. X-Perience 06/14- inc. FR exc. Cupra Please order separately cover for bumper cutout at Seat dealer's.	11/12-04/20			317 132 600 001		60	19.0	10.3	85	2000		305 403 300 113		-06/14 with preliminary setup	S	CAN	C	E	D	L1	H	45
												305 406 300 113		-06/14 without preliminary setup	S	CAN	C	E	D	L1	V	150
												305 407 300 113		06/14-04/20 with preliminary setup	S	CAN	C	E	D	L	H	30
												305 408 300 107	→	06/14-04/20 without preliminary setup	S	CAN	C	E	--	--	V	60
												305 408 300 113		06/14-04/20 without preliminary setup	S	CAN	C	E	D	L	V	60
												344 095 300 113		06/14-04/20 for vehicles with preparation and integrated trailer control unit	S	CAN	--	E	D	L	H	30

Seat Leon III (5F) without preliminary setup 5 doors Seat Leon SC, 3 doors Seat Leon ST, Combi inc. X-Perience inc. FR exc. Cupra	11/12-04/20	KIT		305 418 900 113		60	20.9	10.3	85	2000		included in the KIT 305 438 300 113	inc. WLC 2.0 without preliminary setup	S	CAN	C	E	D	L1	V	90
Seat Leon III (5F) without preliminary setup 5 doors Seat Leon SC, 3 doors Seat Leon ST, Combi inc. X-Perience inc. FR exc. Cupra Please order separately cover for bumper cutout at Seat dealer's.	11/12-04/20	KIT		305 419 900 113		60	20.9	10.3	85	2000		included in the KIT 305 438 300 113	inc. WLC 2.0 without preliminary setup	S	CAN	C	E	D	L1	V	90
Seat Leon III (5F) with preliminary setup 5 doors Seat Leon SC, 3 doors Seat Leon ST, Combi inc. X-Perience inc. FR exc. Cupra	06/14-04/20	KIT		317 154 900 113		60	20.5	10.3	85	2000		included in the KIT 305 407 300 113	06/14-04/20 with preliminary setup	S	CAN	C	E	D	L	H	30
Seat Leon III (5F) with preliminary setup 5 doors Seat Leon SC, 3 doors Seat Leon ST, Combi inc. X-Perience inc. FR exc. Cupra Please order separately cover for bumper cutout at Seat dealer's.	06/14-04/20	KIT		317 155 900 113		60	20.5	10.3	85	2000		included in the KIT 305 407 300 113	06/14-04/20 with preliminary setup	S	CAN	C	E	D	L	H	30
Seat Leon III (5F) without preliminary setup 5 doors Seat Leon SC, 3 doors Seat Leon ST, Combi inc. X-Perience inc. FR exc. Cupra	06/14-04/20	KIT		305 408 900 113		60	19.0	10.3	85	2000		included in the KIT 305 408 300 113	without preliminary setup	S	CAN	C	E	D	L	V	60

Seat















Seat

































Seat Leon III (5F) without preliminary setup 5 doors Seat Leon SC, 3 doors Seat Leon ST, Combi inc. X-Perience inc. FR poza Cupra Please order separately cover for bumper cutout at Seat dealer's.	06/14-04/20	KIT		305 409 900 113		60	21.0	10.3	85	2000		included in the KIT 305 408 300 113	without preliminary setup	S	CAN	C	E	D	L	V	60
Seat Leon IV (KL1) without preliminary setup inc. Hybrid	04/20-	KIT		322 080 900 113		60	21.0	10.3	85	2000		included in the KIT 322 080 300 113	without preliminary setup	S	CAN	C	E	D	L	V	120
Seat Leon IV (KL1) inc. Hybrid	04/20-			317 131 600 001		60	19.0	10.3	85	2000		322 080 300 113	without preliminary setup	S	CAN	C	E	D	L	V	120
												344 095 300 113	04/20- KL1 for vehicles with preparationg and integrated trailer control unit, for PR no. 1M7	S	CAN	--	E	D	L	H	30
Seat Leon IV KL1 inc. Hybrid	04/20-			305 605 600 001		60	19.4	9.0	109	2100		322 080 300 113	without preliminary setup	S	CAN	C	E	D	L	V	120
				305 606 600 001		60	21.4	9.0	109	2100		344 095 300 113	04/20- KL1 for vehicles with preparationg and integrated trailer control unit, for PR no. 1M7	S	CAN	--	E	D	L	H	30
Seat Leon IV KL1 without preliminary setup inc. Hybrid	04/20-	KIT		305 605 900 113		60	21.4	9.0	109	2100		included in the KIT 322 080 300 113	without preliminary setup	S	CAN	C	E	D	L	V	120
		KIT		305 606 900 113		60	23.4	9.0	109	2100		included in the KIT 322 080 300 113	without preliminary setup	S	CAN	C	E	D	L	V	120
Seat Leon IV Sportstourer KL8 inc. Hybrid	03/20-			305 605 600 001		60	19.4	9.0	109	2100		322 080 300 113	without preliminary setup	S	CAN	C	E	D	L	V	120
												344 095 300 113	03/20- KL8 for vehicles with preparationg and integrated trailer control unit, for PR no. 1M7	S	CAN	--	E	D	L	H	30

Seat Leon IV Sportstourer KL8 inc. Hybrid RECEPTION TUBE FOR TOWBALL VISIBLE	03/20-			305 606 600 001		60	21.4	9.0	109	2100		322 080 300 113	without preliminary setup	S	CAN	C	E	D	L	V	120	
												344 095 300 113		S	CAN	--	E	D	L	H	30	
Seat Leon IV Sportstourer KL8 without preliminary setup inc. Hybrid RECEPTION TUBE FOR TOWBALL VISIBLE	03/20-	KIT		305 605 900 113		60	21.4	9.0	109	2100		included in the KIT 322 080 300 113	without preliminary setup	S	CAN	C	E	D	L	V	120	
												KIT			305 606 900 113		60	23.4	9.0	109	2100	included in the KIT 322 080 300 113
Seat Tarraco KN2	09/18-			344 121 600 001		60	14.0	12.3	150	2500		305 408 300 107	→ without preliminary setup	S	CAN	C	E	--	--	V	60	
												305 408 300 113		without preliminary setup	S	CAN	C	E	D	L	V	60
												344 095 300 113		09/18- KN2 for vehicles with preparationg and integrated trailer control unit, for PR no. 1M7	S	CAN	--	E	D	L	H	30
Seat Tarraco KN2 without preliminary setup	09/18-	KIT		344 121 900 113		60	16.0	12.3	150	2500		included in the KIT 305 438 300 113	inc. WLC 2.0 without preliminary setup	S	CAN	C	E	D	L1	V	90	
Seat Tarraco KN2 with preliminary setup	09/18-	KIT		344 071 900 113		60	15.5	12.3	150	2500		included in the KIT 305 407 300 113	with preliminary setup								30	
												KIT			344 070 900 113		60	18.7	12.3	150	2500	included in the KIT 305 407 300 113
Seat Tarraco KN2	09/18-			344 120 600 001		60	16.6	12.3	150	2500		305 408 300 107	→ without preliminary setup	S	CAN	C	E	--	--	V	60	
												305 408 300 113		without preliminary setup	S	CAN	C	E	D	L	V	60
												344 095 300 113		09/18- KN2 for vehicles with preparationg and integrated trailer control unit, for PR no. 1M7	S	CAN	--	E	D	L	H	30

Seat

Seat



















Seat Tarraco KN2 without preliminary setup	09/18-	KIT		344 120 900 113		60	18.5	12.3	150	2500		included in the KIT 305 438 300 113	inc. WLC 2.0 without preliminary setup	S	CAN	C	E	D	L1	V	90
Seat Toledo	03/12--07/15	KIT		317 129 900 113		45	23.0	8.5	50	1200		included in the KIT 317 420 300 113	-07/15	S	CAN	C	E	D1	L1	V	105
		KIT		317 130 900 113		45	23.0	8.5	50	1200		included in the KIT 317 420 300 113	-07/15	S	CAN	C	E	D1	L1	V	105
Seat Toledo type 6L, 5P, 1P	11/04-03/12			344 043 600 001		60	18.0	9.3	100	1650		344 044 300 113		S	CAN	C	E	D1	L1	V	90
				344 044 600 001		60	18.0	9.3	100	1650					S	CAN	C	E	D1	L1	V
		KIT		344 044 900 113		60	19.5	9.3	100	1650		included in the KIT 344 044 300 113		S	CAN	C	E	D1	L1	V	90
Seat Toledo type 6L, 5P, 1P without preliminary setup	11/04-03/12	KIT		344 043 900 113		60	20.0	9.3	100	1650		included in the KIT 344 044 300 113		S	CAN	C	E	D1	L1	V	90
Seat Toledo	03/12-04/19			317 130 600 001		45	21.5	8.5	50	1200		317 114 300 113		S	CAN	C	E	D1	L1	V	90
												317 420 300 113	-07/15	S	CAN	C	E	D1	L1	V	105
Seat Toledo	07/15-04/19	KIT		317 120 900 113		45	25.0	8.5	50	1200		included in the KIT 317 114 300 113		S	CAN	C	E	D1	L1	V	90

Skoda Enyaq IV 5AC	10/20-		317 184 600 001		60	18.2	9.1	100	1400		322 090 300 113	10/20- without preliminary setup	S	CAN	C	E	D	L	V	75
Skoda Fabia I Estate/Saloon exc. GT, inc. Praktik -07	11/00-12/07		317 059 600 001		60	16.5	7.0	50	1200		317 043 300 113		S	FRE	--	E	D1	L1	H	45
		KIT		317 059 900 113		60	18.5	7.0	50	1200		included in the KIT 317 043 300 113		S	FRE	--	E	D1	L1	H
Skoda Fabia II Estate exc. RS	01/08-05/10	KIT		317 085 900 113		40	16.5	7.2	86	1200	included in the KIT 317 400 300 113	-05/10	S	C2	C	E	D1	--	H	45
Skoda Fabia II Estate exc. RS Please order cover for bumper cutout at Skoda dealers.	01/08-05/10	KIT		317 086 900 113		40	16.5	7.2	86	1200	included in the KIT 317 400 300 113	-05/10	S	C2	C	E	D1	--	H	45
Skoda Fabia II Estate exc. RS	01/08-12/14		317 113 600 001		40	14.5	7.2	86	1200		317 400 300 113	-05/10	S	C2	C	E	D1	--	H	45
		KIT		317 113 600 001		40	14.5	7.2	86	1200		317 420 300 113	05/10-	S	CAN	C	E	D1	L1	V
Skoda Fabia II Estate exc. RS Please order cover for bumper cutout at Skoda dealers.	01/08-12/14		317 114 600 001		40	15.0	7.2	86	1200		317 400 300 113	-05/10	S	C2	C	E	D1	--	H	45
		KIT		317 114 600 001		40	15.0	7.2	86	1200		317 420 300 113	05/10-	S	CAN	C	E	D1	L1	V
Skoda Fabia II Estate exc. RS	05/10-12/14	KIT		317 250 900 113		40	16.5	7.2	86	1200	included in the KIT 317 420 300 113	05/10-	S	CAN	C	E	D1	L1	V	105
Skoda Fabia II Estate exc. RS Please order cover for bumper cutout at Skoda dealers.	05/10-12/14	KIT		317 251 900 113		40	16.5	7.2	86	1200	included in the KIT 317 420 300 113	05/10-	S	CAN	C	E	D1	L1	V	105
Skoda Fabia II Hatchback exc. RS + Monte Carlo	06/07-05/10	KIT		317 085 900 113		40	16.5	7.2	86	1200	included in the KIT 317 400 300 113	-05/10	S	C2	C	E	D1	--	H	45
Skoda Fabia II Hatchback exc. RS + Monte Carlo Please order cover for bumper cutout at Skoda dealers.	06/07-05/10		317 086 900 113		40	16.5	7.2	86	1200		included in the KIT 317 400 300 113	-05/10	S	C2	C	E	D1	--	H	45
		KIT		317 086 900 113		40	16.5	7.2	86	1200		317 400 300 113	-05/10	S	C2	C	E	D1	--	H
Skoda Fabia II Hatchback exc. RS + Monte Carlo	06/07-10/14		317 113 600 001		40	14.5	7.2	86	1200		317 400 300 113	-05/10	S	C2	C	E	D1	--	H	45
		KIT		317 113 600 001		40	14.5	7.2	86	1200		317 420 300 113	05/10-	S	CAN	C	E	D1	L1	V
Skoda Fabia II Hatchback exc. RS + Monte Carlo Please order cover for bumper cutout at Skoda dealers.	06/07-10/14		317 114 600 001		40	15.0	7.2	86	1200		317 400 300 113	-05/10	S	C2	C	E	D1	--	H	45
		KIT		317 114 600 001		40	15.0	7.2	86	1200		317 420 300 113	05/10-	S	CAN	C	E	D1	L1	V

Skoda



















Skoda

Skoda Fabia II Hatchback exc. RS + Monte Carlo	05/10-10/14	KIT		317 250 900 113		40	16.5	7.2	86	1200		included in the KIT 317 420 300 113	05/10-	S	CAN	C	E	D1	L1	V	105
Skoda Fabia II Hatchback exc. RS + Monte Carlo Please order cover for bumper cutout at Skoda dealers.	05/10-10/14	KIT		317 251 900 113		40	16.5	7.2	86	1200		included in the KIT 317 420 300 113	05/10-	S	CAN	C	E	D1	L1	V	105
Skoda Fabia III Estate inc. facelift 2019- Attention: tube and socket holder are visible	01/15-04/22			317 114 600 001		40	15.0	7.2	86	1200		317 114 300 113	01/15-04/22	S	CAN	C	E	D1	L1	V	90
		KIT		317 114 900 113		40	18.0	7.2	86	1200		included in the KIT 317 114 300 113	01/15-04/22	S	CAN	C	E	D1	L1	V	90
Skoda Fabia III Estate	01/15-04/22			317 113 600 001		40	14.5	7.2	86	1200		317 114 300 113	01/15-04/22	S	CAN	C	E	D1	L1	V	90
		KIT		317 113 900 113		40	17.5	7.2	86	1200		included in the KIT 317 114 300 113	01/15-04/22	S	CAN	C	E	D1	L1	V	90
Skoda Fabia III Hatchback (542)	11/14-05/21			317 113 600 001		40	14.5	7.2	86	1200		317 114 300 113	11/14-05/21	S	CAN	C	E	D1	L1	V	90
		KIT		317 113 900 113		40	17.5	7.2	86	1200		included in the KIT 317 114 300 113	11/14-05/21	S	CAN	C	E	D1	L1	V	90
Skoda Fabia III Hatchback (542) inc. facelift 2019- Attention: tube and socket holder are visible	11/14-05/21			317 114 600 001		40	15.0	7.2	86	1200		317 114 300 113	11/14-05/21	S	CAN	C	E	D1	L1	V	90
		KIT		317 114 900 113		40	18.0	7.2	86	1200		included in the KIT 317 114 300 113	11/14-05/21	S	CAN	C	E	D1	L1	V	90
Skoda Fabia IV Hatchback PJ3 exc. Monte Carlo	06/21-			317 174 600 001		60	18.3	6.6	80	1100		344 110 300 113	06/21-	S	CAN	C	E	D	L	V	60
		KIT		317 173 900 113		60	18.0	6.6	80	1100		included in the KIT 344 110 300 113	06/21-	S	CAN	C	E	D	L	V	60
		KIT		317 174 900 113		60	20.3	6.6	80	1100		included in the KIT 344 110 300 113	06/21-	S	CAN	C	E	D	L	V	60















Skoda Fabia IV Hatchback PJ3 exc. Monte Carlo	06/21-			317 173 600 001		60	16.0	6.6	80	1100		344 110 300 113	06/21-	S	CAN	C	E	D	L	V	60	
Skoda Kamiq exc. TGI	07/19-			317 171 600 001		60	19.3	7.7	89	2100		344 110 300 113		S	CAN	C	E	D	L	V	60	
				317 172 600 001		60	21.4	11.2	130	2100				S	CAN	C	E	D	L	V	60	
				KIT 	317 171 900 113		60	21.3	7.7	89	2100				included in the KIT 344 110 300 113	S	CAN	C	E	D	L	V
Skoda Kamiq exc. TGI	07/19-	KIT		317 172 900 113		60	23.4	11.2	130	2100		included in the KIT 344 110 300 113		S	CAN	C	E	D	L	V	60	
Skoda Karoq KU7	11/17-11/21			344 121 600 001		60	14.0	12.3	150	2500		305 407 300 113	with preliminary setup	S	CAN	C	E	D	L	H	30	
												305 408 300 107	→ without preliminary setup	S	CAN	C	E	--	--	V	60	
													305 408 300 113	without preliminary setup	S	CAN	C	E	D	L	V	60
Skoda Karoq KU7 without preliminary setup	11/17-11/21	KIT		344 121 900 113		60	16.0	12.3	150	2500		included in the KIT 305 438 300 113	inc. WLC 2.0 without preliminary setup	S	CAN	C	E	D	L1	V	90	
Skoda Karoq KU7 with preliminary setup	11/17-11/21	KIT		344 071 900 113		60	15.5	12.3	150	2500		included in the KIT 305 407 300 113	with preliminary setup	S	CAN	C	E	D	L	H	30	
				KIT		344 072 900 113		60	19.2	12.3	150	2500		included in the KIT 305 407 300 113	with preliminary setup	S	CAN	C	E	D	L	H
Skoda Karoq KU7	11/17-11/21			344 124 600 001		60	17.7	12.3	150	2500		305 407 300 113	with preliminary setup	S	CAN	C	E	D	L	H	30	
												305 408 300 107	→ without preliminary setup	S	CAN	C	E	--	--	V	60	
													305 408 300 113	without preliminary setup	S	CAN	C	E	D	L	V	60
													305 438 300 113	inc. WLC 2.0 without preliminary setup	S	CAN	C	E	D	L1	V	90



















Skoda

Skoda

















Skoda Karoq KU7 without preliminary setup	11/17-11/21	KIT		344 124 900 113		60	19.6	12.3	150	2500		included in the KIT 305 438 300 113		inc. WLC 2.0 without preliminary setup	S	CAN	C	E	D	L1	V	90	
Skoda Kodiaq NS7 150 BHP Diesel Manual 4x4 7 seats is not permitted to tow by manufacturer. inc. facelift 2021-	10/16-			344 121 600 001		60	14.0	12.3	150	2500		305 408 300 107		without preliminary setup	S	CAN	C	E	--	--	V	60	
												305 408 300 113		without preliminary setup	S	CAN	C	E	D	L	V	60	
Skoda Kodiaq NS7 without preliminary setup 150 BHP Diesel Manual 4x4 7 seats is not permitted to tow by manufacturer. inc. facelift 2021-	10/16-	KIT		344 121 900 113		60	16.0	12.3	150	2500		included in the KIT 305 438 300 113		inc. WLC 2.0 without preliminary setup	S	CAN	C	E	D	L1	V	90	
Skoda Kodiaq NS7 with preliminary setup 150 BHP Diesel Manual 4x4 7 seats is not permitted to tow by manufacturer. inc. facelift 2021-	10/16-	KIT		344 071 900 113		60	15.5	12.3	150	2500		included in the KIT 305 407 300 113		with preliminary setup	S	CAN	C	E	D	L	H	30	
												344 070 900 113		with preliminary setup	S	CAN	C	E	D	L	H	30	
Skoda Kodiaq NS7 150 BHP Diesel Manual 4x4 7 seats is not permitted to tow by manufacturer. inc. facelift 2021-	10/16-			344 120 600 001		60	16.6	12.3	150	2500		305 408 300 107		without preliminary setup	S	CAN	C	E	--	--	V	60	
												305 408 300 113		without preliminary setup	S	CAN	C	E	D	L	V	60	
Skoda Kodiaq NS7 without preliminary setup 150 BHP Diesel Manual 4x4 7 seats is not permitted to tow by manufacturer. inc. facelift 2021-	10/16-	KIT		344 120 900 113		60	18.5	12.3	150	2500		included in the KIT 305 438 300 113		inc. WLC 2.0 without preliminary setup	S	CAN	C	E	D	L1	V	90	
Skoda Octavia I Saloon/Estate type 1U exc. 4 WD, inc. RS Note: For towing capacities of 1400 kg and more please check the operating instructions of your car.	12/96-01/05			305 223 600 001		120	16.8	8.9	75	1650		317 015 300 113			S	FRE	--	E	D1	L1	H	45	
															KIT		317 016 900 113		90	18.2	8.4	60	1500



















Skoda

Skoda Octavia III (5E) Saloon and Estate inc. RS and Scout inc. vehicles with gas drive	02/13-01/20			317 131 600 001		60	19.0	10.3	85	2000		305 403 300 113	-06/14 with preliminary setup	S	CAN	C	E	D	L1	H	45	
				317 132 600 001		60	19.0	10.3	85	2000		305 406 300 113	-06/14 without preliminary setup	S	CAN	C	E	D	L1	V	150	
													305 407 300 113	06/14-01/20 with preliminary setup	S	CAN	C	E	D	L	H	30
													305 408 300 107	06/14-01/20 without preliminary setup	S	CAN	C	E	--	--	V	60
													305 408 300 113	06/14-01/20 without preliminary setup	S	CAN	C	E	D	L	V	60
Skoda Octavia III (5E) without preliminary setup Saloon and Estate inc. RS and Scout inc. vehicles with gas drive	02/13-01/20	KIT		305 418 900 113		60	20.9	10.3	85	2000		included in the KIT 305 438 300 113	inc. WLC 2.0 without preliminary setup	S	CAN	C	E	D	L1	V	90	
				305 419 900 113		60	20.9	10.3	85	2000		included in the KIT 305 438 300 113	inc. WLC 2.0 without preliminary setup	S	CAN	C	E	D	L1	V	90	
Skoda Octavia III (5E) without preliminary setup Saloon and Estate inc. RS and Scout inc. vehicles with gas drive	06/14-01/20	KIT		305 408 900 113		60	19.0	10.3	85	2000		included in the KIT 305 408 300 113	06/14-01/20 without preliminary setup	S	CAN	C	E	D	L	V	60	
				305 409 900 113		60	21.0	10.3	85	2000		included in the KIT 305 408 300 113	06/14-01/20 without preliminary setup	S	CAN	C	E	D	L	V	60	
Skoda Octavia III (5E) with preliminary setup Saloon and Estate inc. RS and Scout inc. vehicles with gas drive	06/14-01/20	KIT		317 155 900 113		60	20.5	10.3	85	2000		included in the KIT 305 407 300 113	06/14-01/20 with preliminary setup	S	CAN	C	E	D	L	H	30	
Skoda Octavia III (5E) with preliminary setup Saloon and Estate inc. RS and Scout inc. vehicles with gas drive	06/14-01/20	KIT		317 154 900 113		60	20.5	10.3	85	2000		included in the KIT 305 407 300 113	06/14-01/20 with preliminary setup	S	CAN	C	E	D	L	H	30	

Skoda Octavia IV Combi (NX5) without preliminary setup inc. AdBlue For vehicles without towbar preparation, please order the original spoiler from the vehicle dealer. Please order separately: holder for antenna amplifier 917131632001	01/20-	KIT		322 080 900 113		60	21.0	10.3	85	2000		included in the KIT 322 080 300 113	without preliminary setup	S	CAN	C	E	D	L	V	120
		KIT		322 081 900 113		60	21.0	10.3	85	2000		included in the KIT 322 080 300 113	without preliminary setup	S	CAN	C	E	D	L	V	120
Skoda Octavia IV Combi (NX5) inc. AdBlue For vehicles without towbar preparation, please order the original spoiler from the vehicle dealer. Please order separately: holder for antenna amplifier 917131632001	01/20-			317 131 600 001		60	19.0	10.3	85	2000		322 080 300 113	without preliminary setup	S	CAN	C	E	D	L	V	120
				317 132 600 001		60	19.0	10.3	85	2000		322 081 300 113	with preliminary setup	S	CAN	C	E	D	L	H	45
Skoda Octavia IV Combi (NX5) inc. AdBlue inc. Hybrid For vehicles without towbar preparation, please order the original spoiler from the vehicle dealer.	01/20-			322 093 600 001		60	17.7	12.3	150	2500		322 080 300 113	without preliminary setup	S	CAN	C	E	D	L	V	120
				322 094 600 001		60	17.7	12.3	150	2500		322 081 300 113	with preliminary setup	S	CAN	C	E	D	L	H	45
Skoda Octavia IV Combi (NX5) without preliminary setup inc. AdBlue inc. Hybrid For vehicles without towbar preparation, please order the original spoiler from the vehicle dealer.	01/20-	KIT		322 093 900 113		60	19.6	12.3	150	2500		included in the KIT 322 080 300 113	without preliminary setup	S	CAN	C	E	D	L	V	120
		KIT		322 094 900 113		60	19.6	12.3	150	2500		included in the KIT 322 080 300 113	without preliminary setup	S	CAN	C	E	D	L	V	120
Skoda Octavia IV Saloon (NX3) without preliminary setup inc. AdBlue For vehicles without towbar preparation, please order the original spoiler from the vehicle dealer. Please order separately: holder for antenna amplifier 917131632001	01/20-	KIT		322 080 900 113		60	21.0	10.3	85	2000		included in the KIT 322 080 300 113	without preliminary setup	S	CAN	C	E	D	L	V	120

























Skoda





















Skoda Octavia IV Saloon (NX3) inc. AdBlue For vehicles without towbar preparation, please order the original spoiler from the vehicle dealer. Please order separately: holder for antenna amplifier 917131632001	01/20-		317 131 600 001		60	19.0	10.3	85	2000		322 080 300 113	without preliminary setup	S	CAN	C	E	D	L	V	120
											322 081 300 113	with preliminary setup	S	CAN	C	E	D	L	H	45
Skoda Octavia IV Saloon (NX3) inc. AdBlue inc. Hybrid For vehicles without towbar preparation, please order the original spoiler from the vehicle dealer.	01/20-		322 093 600 001		60	17.7	12.3	150	2500		322 080 300 113	without preliminary setup	S	CAN	C	E	D	L	V	120
											322 094 600 001	with preliminary setup	S	CAN	C	E	D	L	H	45
Skoda Octavia IV Saloon (NX3) without preliminary setup inc. AdBlue inc. Hybrid For vehicles without towbar preparation, please order the original spoiler from the vehicle dealer.	01/20-	KIT			60	19.6	12.3	150	2500		included in the KIT 322 080 300 113	without preliminary setup	S	CAN	C	E	D	L	V	120
											included in the KIT 322 080 300 113	without preliminary setup	S	CAN	C	E	D	L	V	120
Skoda Rapid / Rapid Spaceback inc. Monte Carlo	10/12-07/15	KIT			45	23.0	8.5	50	1200		included in the KIT 317 420 300 113	-07/15	S	CAN	C	E	D1	L1	V	105
											included in the KIT 317 420 300 113	-07/15	S	CAN	C	E	D1	L1	V	105
Skoda Rapid / Rapid Spaceback inc. Monte Carlo exc. Scoutline	10/12-12/19				45	21.5	8.5	50	1200		317 420 300 113	-07/15	S	CAN	C	E	D1	L1	V	105
Skoda Rapid / Rapid Spaceback inc. Monte Carlo exc. Scoutline	07/15-12/19	KIT			45	25.0	8.5	50	1200		included in the KIT 317 114 300 113	07/15-	S	CAN	C	E	D1	L1	V	90
Skoda Roomster inc. Skoda Praktik 07- inc. Scout	09/06-05/10	KIT			40	19.0	7.5	50	1200		included in the KIT 317 400 300 113	-05/10	S	C2	C	E	D1	--	H	45
Skoda Roomster inc. Skoda Praktik 07- inc. Scout Please order cover for bumper cutout at Skoda-dealers, order-no. XEA 77001.	09/06-05/10	KIT			40	19.0	7.5	50	1200		included in the KIT 317 400 300 113	-05/10	S	C2	C	E	D1	--	H	45

Skoda Roomster inc. Skoda Praktik 07- inc. Scout	09/06-04/15		317 063 600 001		40	17.0	7.5	50	1200		317 400 300 113	-05/10	S	C2	C	E	D1	--	H	45
											317 420 300 113	05/10-	S	CAN	C	E	D1	L1	V	105
Skoda Roomster inc. Skoda Praktik 07- inc. Scout Please order cover for bumper cutout at Skoda-dealers, order-no. XEA 77001.	09/06-04/15		317 064 600 001		40	17.0	7.5	50	1200		317 400 300 113	-05/10	S	C2	C	E	D1	--	H	45
											317 420 300 113	05/10-	S	CAN	C	E	D1	L1	V	105
Skoda Roomster inc. Skoda Praktik 07- inc. Scout	05/10-04/15	KIT		317 420 900 113		40	19.0	7.5	50	1200	included in the KIT 317 420 300 113	05/10-	S	CAN	C	E	D1	L1	V	105
Skoda Roomster inc. Skoda Praktik 07- inc. Scout Please order cover for bumper cutout at Skoda-dealers, order-no. XEA 77001.	05/10-04/15	KIT		317 421 900 113		40	19.0	7.5	50	1200	included in the KIT 317 420 300 113	05/10-	S	CAN	C	E	D1	L1	V	105
Skoda Scala exc. CNG Please check if the trailer load is entered in the vehicle documents.	02/19-		317 169 600 001		60	20.9	10.3	120	2000		344 110 300 113		S	CAN	C	E	D	L	V	60
				317 170 600 001		60	23.2	10.3	120	2000										
		KIT		317 170 900 113		60	25.2	10.3	120	2000	included in the KIT 344 110 300 113	S	CAN	C	E	D	L	V	60	
Skoda Scala only for vehicles with trailer preparation exc. CNG	02/19-	KIT		317 169 900 113		60	22.9	10.3	120	2000	included in the KIT 344 110 300 113		S	CAN	C	E	D	L	V	60
Skoda Superb exc. vehicles with tuning set by M +S	03/02-06/08		321 505 600 001			90	20.8	10.3	85	1800	300 072 300 113		--	FRE	--	--	D1	L1	V	













Skoda

Skoda

























Skoda Superb Estate II facelift from 06/13-	12/09-05/15			317 104 600 001		40	18.0	10.6	100	2000		321 600 300 113			S	FRE	C	E	D	L1	V	105
				317 102 600 001		40	19.0	10.6	100	2000												
	KIT		317 104 900 113		40	20.0	10.6	100	2000		included in the KIT 321 600 300 113			S	FRE	C	E	D	L1	V	105	
	KIT		317 102 900 113		40	21.0	10.6	100	2000		included in the KIT 321 600 300 113			S	FRE	C	E	D	L1	V	105	
Skoda Superb Estate III (3V5) inc. Sportline inc. Plugin Hybrid (Please check if the trailer load is entered in the vehicle documents.)	03/15-			317 140 600 001		90	15.0	11.5	100	2200		305 407 300 113		with preliminary setup	S	CAN	C	E	D	L	H	30
				317 141 600 001		90	15.9	11.5	100	2200		305 408 300 107	→	without preliminary setup	S	CAN	C	E	--	--	V	60
												305 408 300 113		without preliminary setup	S	CAN	C	E	D	L	V	60
Skoda Superb Estate III (3V5) without preliminary setup inc. Sportline inc. Plugin Hybrid (Please check if the trailer load is entered in the vehicle documents.)	03/15-	KIT		317 140 900 113		90	19.6	11.5	100	2200		included in the KIT 305 408 300 113		without preliminary setup	S	CAN	C	E	D	L	V	60
		KIT		317 143 900 113		90	17.4	11.5	100	2200		included in the KIT 305 438 300 113		inc. WLC 2.0 without preliminary setup	S	CAN	C	E	D	L1	V	90
		KIT		317 141 900 113		90	19.9	11.5	100	2200		included in the KIT 305 408 300 113		without preliminary setup	S	CAN	C	E	D	L	V	60
		KIT		317 142 900 113		90	17.8	11.5	100	2200		included in the KIT 305 438 300 113		inc. WLC 2.0 without preliminary setup	S	CAN	C	E	D	L1	V	90
Skoda Superb Estate III (3V5) with preliminary setup inc. Sportline inc. Plugin Hybrid (Please check if the trailer load is entered in the vehicle documents.)	03/15-	KIT		317 138 900 113		90	17.0	11.5	100	2200		included in the KIT 305 407 300 113		with preliminary setup	S	CAN	C	E	D	L	H	30
		KIT		317 139 900 113		90	17.5	11.5	100	2200		included in the KIT 305 407 300 113		with preliminary setup	S	CAN	C	E	D	L	H	30





Skoda Superb Saloon II facelift from 06/13-	06/08-05/15			317 104 600 001		40	18.0	10.6	100	2000		321 600 300 113			S	FRE	C	E	D	L1	V	105
				317 102 600 001		40	19.0	10.6	100	2000												
		KIT		317 104 900 113		40	20.0	10.6	100	2000		included in the KIT 321 600 300 113			S	FRE	C	E	D	L1	V	105
		KIT		317 102 900 113		40	21.0	10.6	100	2000		included in the KIT 321 600 300 113			S	FRE	C	E	D	L1	V	105
Skoda Superb Saloon III (3V5) inc. Sportline inc. Plugin Hybrid (Please check if the trailer load is entered in the vehicle documents.)	03/15-			317 141 600 001		90	15.9	11.5	100	2200		305 407 300 113		with preliminary setup	S	CAN	C	E	D	L	H	30
												305 408 300 107	→	without preliminary setup	S	CAN	C	E	--	--	V	60
													305 408 300 113		without preliminary setup	S	CAN	C	E	D	L	V
Skoda Superb Saloon III (3V5) inc. Sportline inc. Plugin Hybrid (Please check if the trailer load is entered in the vehicle documents.)	03/15-			317 140 600 001		90	15.0	11.5	100	2200		305 407 300 113		with preliminary setup	S	CAN	C	E	D	L	H	30
												305 408 300 107	→	without preliminary setup	S	CAN	C	E	--	--	V	60
													305 408 300 113		without preliminary setup	S	CAN	C	E	D	L	V
Skoda Superb Saloon III (3V5) without preliminary setup inc. Sportline inc. Plugin Hybrid (Please check if the trailer load is entered in the vehicle documents.)	03/15-	KIT		317 140 900 113		90	19.6	11.5	100	2200		included in the KIT 305 408 300 113		without preliminary setup	S	CAN	C	E	D	L	V	60
		KIT		317 143 900 113		90	17.4	11.5	100	2200		included in the KIT 305 438 300 113		inc. WLC 2.0 without preliminary setup	S	CAN	C	E	D	L1	V	90
		KIT		317 141 900 113		90	19.9	11.5	100	2200		included in the KIT 305 408 300 113		without preliminary setup	S	CAN	C	E	D	L	V	60
		KIT		317 142 900 113		90	17.8	11.5	100	2200		included in the KIT 305 438 300 113		inc. WLC 2.0 without preliminary setup	S	CAN	C	E	D	L1	V	90

Skoda



















Skoda Superb Saloon III (3V5) with preliminary setup inc. Sportline inc. Plugin Hybrid (Please check if the trailer load is entered in the vehicle documents.)	03/15-	KIT		317 138 900 113		90	17.0	11.5	100	2200	included in the KIT 305 407 300 113	with preliminary setup	S	CAN	C	E	D	L	H	30
		KIT		317 139 900 113		90	17.5	11.5	100	2200	included in the KIT 305 407 300 113	with preliminary setup	S	CAN	C	E	D	L	H	30
Skoda Yeti	08/09-12/17			317 125 600 001		40	18.0	10.6	85	2100	317 079 300 107 317 079 300 113	→	S	CAN	C	E	--	--	V	105
		KIT		317 080 900 113		40	20.0	10.6	85	2100	included in the KIT 317 079 300 113		S	CAN	C	E	D	L1	V	105
				317 128 600 001		40	19.5	10.6	85	2100	317 079 300 107 317 079 300 113	→	S	CAN	C	E	--	--	V	105
Skoda Yeti For the cutout in the bumper a special tool is necessary. We would therefore recommend to let the cutout be made at Skoda dealers. Please order cover and frame for bumper cutout at Skoda dealers.	08/09-12/17	KIT		317 105 900 113		40	20.5	10.6	85	2100	included in the KIT 317 079 300 113		S	CAN	C	E	D	L1	V	105

Subaru



Subaru Levorg	09/15-12/21		348 064 600 001	→ 	60	22.5	8.7	90	1500													
				348 065 600 001		60	24.0	8.7	90	1500												
Subaru Outback (BS)	03/15-07/20		348 062 600 001		60	24.5	10.5	90	2000	348 062 300 113			S	FRE	--	E1	D1	L1	V	75		
				348 063 600 001		60	26.0	10.5	90												2000	
Subaru Outback BT	05/21-		348 085 600 001		90	19.2	10.8	125	2100													
				348 086 600 001		90	21.5	10.8	125	2100												
Subaru Solterra	06/22-		348 087 600 001		75	19.8	5.7	75	750													
				348 088 600 001		75	19.8	5.7	75	750												
Subaru Trezia	03/11-12/14		335 414 600 001		60	21.0	5.8	50	900													
Subaru XV (GP)	03/12-10/17		348 037 600 001		90	20.0	8.9	75	1600	348 037 300 113			S	A	--	--	D	L1	V	90		
			KIT		348 037 900 113		90	22.0	8.9												75	1600
Subaru XV (GT)	10/17-10/23		348 078 600 001			75	21.4	8.0	90	348 073 300 113	-10/23		S	A	C1	E1	D	L1	V	90		
			KIT		348 078 900 113			75	22.8												8.0	90







Tesla Model 3 (5YJ3) Please check if the trailer load is entered in the vehicle documents.	01/19-			351 008 600 001			60	17.4	6.8	100	1000		351 008 300 113	01/19-	S	FRE	--	E2	--	--	H	45
													351 009 300 113	01/19-	S	A	--	E2	D	L1	H	60
Tesla Model 3	01/19-	KIT		351 008 900 113			60	19.5	6.8	100	1000		included in the KIT 351 009 300 113	01/19-	S	A	--	E2	D	L1	H	60

Toyota















Toyota Auris Touring Sports exc. Hybrid	07/13-03/19			335 425 600 001		90	17.0	8.7	75	1500		335 423 300 113			S	FRE	--	E2	D	L1	V	120
		KIT		335 425 900 113		90	19.0	8.7	75	1500		included in the KIT 335 423 300 113			S	FRE	--	E2	D	L1	V	120
Toyota Avensis Estate / Touring Sports T27	01/09-10/18			335 345 600 001		60	24.0	10.3	80	2000		335 345 300 113			S	FRE	--	--	D	L1	V	105
				335 346 600 001		60	24.0	10.3	80	2000						S	FRE	--	--	D	L1	V
		KIT		335 345 900 113		60	26.0	10.3	80	2000		included in the KIT 335 345 300 113			S	FRE	--	--	D	L1	V	105
		KIT		335 346 900 113		60	26.0	10.3	80	2000		included in the KIT 335 345 300 113			S	FRE	--	--	D	L1	V	105
Toyota C-HR X1 inc. Hybrid	01/17-10/19	KIT		335 495 900 113		60	30.0	7.6	75	1300		included in the KIT 335 494 300 113	-10/19		S	FRE	--	E2	D	L1	H	75
Toyota C-HR X1 inc. Hybrid	01/17-10/23			335 495 600 001		60	25.5	7.6	75	1300		335 494 300 113	-10/19		S	FRE	--	E2	D	L1	H	75
Toyota Corolla (E21)	10/18-			335 514 600 001		60	18.9	7.6	90	2100		335 423 300 113			S	FRE	--	E2	D	L1	V	120
				335 515 600 001		60	21.9	7.6	90	2100						S	FRE	--	E2	D	L1	V
		KIT		335 514 900 113		60	20.6	7.6	90	2100		included in the KIT 335 423 300 113			S	FRE	--	E2	D	L1	V	120
		KIT		335 515 900 113		60	23.6	7.6	90	2100		included in the KIT 335 423 300 113			S	FRE	--	E2	D	L1	V	120























Toyota

Toyota Hilux Extra Cab, 4x4 inc. towball	09/16-		335 505 600 001			30	34.4	16.4	200	3500		335 456 300 113	09/16-	S	FRE	--	--	D	L1	V	75
		KIT		335 505 900 113			30	35.0	16.4	200	3500		included in the KIT 335 456 300 113	09/16-	S	FRE	--	--	D	L1	V
Toyota Hilux Single Cab, 4x4 inc. towball only vehicles with underrun guard official type ident no. of vehicle's type plate: e11*2007/46*0148	10/10-		335 408 600 001			30	10.0	13.8	120	2500		335 456 300 113	09/16-	S	FRE	--	--	D	L1	V	75
Toyota Hilux Single Cab, 4x4 inc. towball only vehicles with underrun guard official type ident no. of vehicle's type plate: e11*2007/46*0148	10/10-08/16		335 408 900 113			30	12.0	13.8	120	2500											
Toyota Hilux Single Cab, 4x4 inc. towball	09/16-		335 505 600 001			30	34.4	16.4	200	3500		335 456 300 113	09/16-	S	FRE	--	--	D	L1	V	75
		KIT		335 505 900 113			30	35.0	16.4	200	3500		included in the KIT 335 456 300 113	09/16-	S	FRE	--	--	D	L1	V
Toyota Landcruiser J 12	01/03-10/09		335 294 600 001			75	8.5	16.3	130	3500		300 210 300 113		--	A	--	E1	D1	L1	V	90
Toyota Landcruiser J 15 fitting towballs: 329062600001,329042600001, 329072600001. Please order separately cover for bumper cutout at Toyota dealers.	11/09-		335 397 600 001				16.0	16.3	130	3500		335 398 300 113		S	A	--	--	D	L1	H	75
Toyota Landcruiser J 15 inc. towball: 329062600001 Please order separately cover for bumper cutout at Toyota dealers.	11/09-	KIT		335 397 900 113			18.0	15.9	130	3500		included in the KIT 335 398 300 113		S	A	--	--	D	L1	H	75
Toyota Landcruiser V8 / 200 J20	03/08-06/21		335 359 600 001			90	15.0	17.2	140	3500		300 210 300 113		--	A	--	E1	D1	L1	V	90





























Toyota Proace	04/12-02/16			306 331 600 001		75	22.5	12.2	122	2200		304 400 300 113			S	CAN	C1	E	D	L1	H	105
				306 333 600 001		75	22.5	12.2	122	2200												
	KIT			306 331 900 113		75	22.5	12.2	122	2200		included in the KIT 304 400 300 113			S	CAN	C1	E	D	L1	H	105
				306 333 900 113		75	24.5	12.2	122	2200		included in the KIT 304 400 300 113			S	CAN	C1	E	D	L1	H	105
Toyota Proace inc. Proace Electric inc. towball	03/16-			304 190 600 001		45	26.0	13.9	104	2500		304 157 300 113	-10/19	S	CAN	C	E	D	L1	H	90	
												314 585 300 113	11/19- inc. WLC 2.0 with preliminary setup inc. Proace Electric	S	FRE	C	E	D	L1	H	75	
Toyota Proace inc. Proace Electric	03/16-			335 106 600 001		60	25.5	13.9	104	2500		304 157 300 113	-10/19	S	CAN	C	E	D	L1	H	90	
												314 585 300 113	11/19- inc. WLC 2.0 with preliminary setup inc. Proace Electric	S	FRE	C	E	D	L1	H	75	
Toyota Proace inc. towball	03/16-10/19	KIT		304 190 900 113		45	31.0	13.9	104	2500		included in the KIT 304 157 300 113	-10/19	S	CAN	C	E	D	L1	H	90	
Toyota Proace	03/16-10/19	KIT		335 106 900 113		60	28.5	13.9	104	2500		included in the KIT 304 157 300 113	-10/19	S	CAN	C	E	D	L1	H	90	
Toyota Proace inc. Proace Electric with preliminary setup inc. towball	11/19-	KIT		314 576 900 113		45	27.7	13.9	104	2500		included in the KIT 314 585 300 113	11/19- inc. WLC 2.0 with preliminary setup inc. Proace Electric	S	FRE	C	E	D	L1	H	75	
Toyota Proace inc. Proace Electric with preliminary setup	11/19-	KIT		314 578 900 113		60	27.2	13.9	104	2500		included in the KIT 314 585 300 113	11/19- inc. WLC 2.0 with preliminary setup inc. Proace Electric	S	FRE	C	E	D	L1	H	75	

Toyota

Toyota Proace City L1 inc. City Verso	11/19-			304 207 600 001			60	20.0	8.6	75	1500	314 594 300 113	inc. WLC 2.0	S	A	C	E	D	L	V	90										
				304 118 600 001			90	17.0	8.4	64	1600																				
				304 209 600 001			60	20.5	8.6	75	1500																				
		KIT		304 207 900 113			60	21.2	8.6	75	1500											included in the KIT 314 594 300 113	inc. WLC 2.0	S	A	C	E	D	L	V	90
		KIT		304 209 900 113			60	21.8	8.6	75	1500											included in the KIT 314 594 300 113	inc. WLC 2.0	S	A	C	E	D	L	V	90
Toyota Proace City L2 inc. City Verso	11/19-			304 210 600 001			60	21.0	8.6	75	1500	314 594 300 113	inc. WLC 2.0	S	A	C	E	D	L	V	90										
				304 212 600 001			60	21.5	8.6	75	1500																				
		KIT		304 210 900 113			60	22.2	8.6	75	1500											included in the KIT 314 594 300 113	inc. WLC 2.0	S	A	C	E	D	L	V	90
		KIT		304 212 900 113			60	22.8	8.6	75	1500											included in the KIT 314 594 300 113	inc. WLC 2.0	S	A	C	E	D	L	V	90
		Toyota Proace Verso inc. Proace Verso Electric	03/16-			335 106 600 001			60	25.5	13.9											104	2500	304 157 300 113	-10/19	S	CAN	C	E	D	L1
	335 106 600 001						60	25.5	13.9	104	2500	314 585 300 113	11/19- inc. WLC 2.0 with preliminary setup inc. Proace Verso Electric	S	FRE	C	E	D	L1	H	75										
	304 190 600 001						45	26.0	13.9	104	2500	314 585 300 113	11/19- inc. WLC 2.0 with preliminary setup inc. Proace Verso Electric	S	FRE	C	E	D	L1	H	75										
Toyota Proace Verso	03/16-10/19	KIT		335 106 900 113			60	28.5	13.9	104	2500	included in the KIT 304 157 300 113	-10/19	S	CAN	C	E	D	L1	H	90										
Toyota Proace Verso inc. towball	03/16-10/19	KIT		304 190 900 113			45	31.0	13.9	104	2500	included in the KIT 304 157 300 113	-10/19	S	CAN	C	E	D	L1	H	90										



















Toyota Proace Verso inc. Proace Verso Electric with preliminary setup inc. towball	11/19-	KIT		314 576 900 113			45	27.7	13.9	104	2500			included in the KIT 314 585 300 113		11/19- inc. WLC 2.0 with preliminary setup inc. Proace Verso Electric	S	FRE	C	E	D	L1	H	75
Toyota Proace Verso inc. Proace Verso Electric with preliminary setup	11/19-	KIT		314 578 900 113			60	27.2	13.9	104	2500			included in the KIT 314 585 300 113		11/19- inc. WLC 2.0 with preliminary setup inc. Proace Verso Electric	S	FRE	C	E	D	L1	H	75
Toyota RAV4 not with rear step	06/00-02/06			335 246 600 001			>150	16.7	9.8	75	2000													
Toyota RAV4 all models	03/06-13			335 325 600 001			90	36.0	10.4	80	2000			335 251 300 113			S	FRE	--	--	D1	L1	H	60
		KIT		335 348 600 001			90	37.0	10.4	80	2000			included in the KIT 335 251 300 113			S	FRE	--	--	D1	L1	H	60
Toyota RAV4 IV A4 exc. vehicles with foot sensor	02/13-12/18			335 418 600 001			120	37.0	10.9	80	2000			335 419 300 113		-12/18	S	A	--	E1	D	L1	H	60
				335 419 600 001			120	38.0	10.9	80	2000													
		KIT		335 418 900 113			120	37.0	10.9	80	2000			included in the KIT 335 419 300 113		-12/18	S	A	--	E1	D	L1	H	60
		KIT		335 419 900 113			120	40.0	10.9	80	2000			included in the KIT 335 419 300 113		-12/18	S	A	--	E1	D	L1	H	60
Toyota RAV4 V A5, H5 inc. Plugin Hybrid exc. vehicles with tailgate that opens by sensor exc. GR Sport	11/18-			335 510 600 001			60	23.0	10.2	100	2000			335 110 300 113			S	A	--	E2	D	L1	H	45
				335 511 600 001			60	25.0	10.2	100	2000													
		KIT		335 510 900 113			60	24.4	10.2	100	2000			included in the KIT 335 110 300 113			S	A	--	E2	D	L1	H	45
		KIT		335 511 900 113			60	26.8	10.2	100	2000			included in the KIT 335 110 300 113			S	A	--	E2	D	L1	H	45

Toyota

Vauxhall Astra J Hatchback exc. vehicles with bike carrier system Flex-Fix	12/09-09/15		314 474 600 001		60	23.0	9.6	75	1800	314 386 300 113	S	CAN	--	E	D	L1	V	90	
			314 473 600 001		60	23.0	9.6	75	1800										
	KIT		314 474 900 113		60	25.0	9.6	75	1800	included in the KIT 314 386 300 113	S	CAN	--	E	D	L1	V	90	
	KIT		314 473 900 113		60	25.0	9.6	75	1800	included in the KIT 314 386 300 113	S	CAN	--	E	D	L1	V	90	
Vauxhall Astra J Sports Tourer exc. vehicles with bike carrier system Flex-Fix Please order separately cover for bumper cutout at Vauxhall dealers.	11/10-01/16		314 406 600 001		60	25.0	9.6	75	1800	314 386 300 113	S	CAN	--	E	D	L1	V	90	
		KIT		314 406 900 113		60	31.0	9.6	75	1800	included in the KIT 314 386 300 113	S	CAN	--	E	D	L1	V	90
Vauxhall Astra J Sports Tourer exc. vehicles with bike carrier system Flex-Fix	11/10-01/16		314 407 600 001		60	24.5	9.6	75	1800	314 386 300 113	S	CAN	--	E	D	L1	V	90	
		KIT		314 407 900 113		60	26.5	9.6	75	1800	included in the KIT 314 386 300 113	S	CAN	--	E	D	L1	V	90
Vauxhall Astra K Hatchback 5 doors not for vehicles with CVT transmission	09/15-12/21		314 513 600 001		60	21.0	9.9	75	1700	314 514 300 113	S	CAN	--	E2	D	L1	V	90	
		KIT		314 513 900 113		60	24.0	9.9	75	1700	included in the KIT 314 514 300 113	S	CAN	--	E2	D	L1	V	90
Opel Astra K SW / Sports Tourer not for vehicles with CVT transmission Please order spoiler inc. cover for bumper cutout at Vauxhall-dealers. To guarantee an optimal fit of the bumper it is necessary to mount a polystyrene carrier, please order from Vauxhall-dealer.	03/16-12/21		314 516 600 001		60	19.5	9.9	75	1700	314 514 300 113	S	CAN	--	E2	D	L1	V	90	
			314 515 600 001		60	20.0	9.9	75	1700										
		KIT		314 516 900 113		60	23.0	9.9	75	1700	included in the KIT 314 514 300 113	S	CAN	--	E2	D	L1	V	90
		KIT		314 515 900 113		60	24.5	9.9	75	1700	included in the KIT 314 514 300 113	S	CAN	--	E2	D	L1	V	90





























Vauxhall



























Opel Astra L 5 doors O5 inc. Plugin-Hybrid	10/21-			314 603 600 001		90	21.7	9.2	90	1650		314 602 300 113		10/21- inc. Plug- in Hybrid	S	CAN	C	E	D	L1	H	75
		KIT		314 603 900 113		90	24.2	9.2	90	1650		included in the KIT 314 602 300 113		10/21- inc. Plug- in Hybrid	S	CAN	C	E	D	L1	H	75
Opel Astra L Sports Tourer O5 inc. Plugin-Hybrid	10/21-			314 604 600 001		90	20.0	9.2	108	1650		314 602 300 113		10/21- inc. Plug- in Hybrid	S	CAN	C	E	D	L1	H	75
				314 605 600 001		90	22.0	9.2	112	1650												
		KIT		314 604 900 113		90	22.0	9.2	108	1650		included in the KIT 314 602 300 113		10/21- inc. Plug- in Hybrid	S	CAN	C	E	D	L1	H	75
		KIT		314 605 900 113		90	24.0	9.2	108	1650		included in the KIT 314 602 300 113		10/21- inc. Plug- in Hybrid	S	CAN	C	E	D	L1	H	75
Vauxhall Combo Van exc. vehicles with gas drive (CNG) exc. vehicles with park distance control	02/12-08/18			306 368 600 001		60	23.0	9.2	100	1500		306 605 300 113			S	FRE	--	E	D1	L1	V	90
		KIT		306 368 900 113		45	25.0	9.2	100	1500		included in the KIT 306 605 300 113			S	FRE	--	E	D1	L1	V	90
Vauxhall Combo Van exc. vehicles with gas drive (CNG)	02/12-08/18			306 369 600 001		60	25.0	9.2	100	1500		306 605 300 113			S	FRE	--	E	D1	L1	V	90
		KIT		306 369 900 113		60	27.0	9.2	100	1500		included in the KIT 306 605 300 113			S	FRE	--	E	D1	L1	V	90
Vauxhall Combo Van inc. towball for vehicles with gas drive (CNG)	02/12-08/18			306 382 600 001		60	25.0	7.0	75	1000		306 605 300 113			S	FRE	--	E	D1	L1	V	90
		KIT		306 382 900 113		60	27.0	7.0	75	1000		included in the KIT 306 605 300 113			S	FRE	--	E	D1	L1	V	90

Vauxhall Combo Van L1 Cargo + Life	09/18-		304 207 600 001			60	20.0	8.6	75	1500		314 594 300 113	inc. WLC 2.0	S	A	C	E	D	L	V	90	
			304 209 600 001			60	20.5	8.6	75	1500												
	KIT		304 207 900 113			60	21.2	8.6	75	1500		included in the KIT 314 594 300 113	inc. WLC 2.0	S	A	C	E	D	L	V	90	
	KIT		304 209 900 113			60	21.8	8.6	75	1500		included in the KIT 314 594 300 113	inc. WLC 2.0	S	A	C	E	D	L	V	90	
Vauxhall Combo Van L2 Cargo + Life	09/18-		304 210 600 001			60	21.0	8.6	75	1500		314 594 300 113	inc. WLC 2.0	S	A	C	E	D	L	V	90	
			304 212 600 001			60	21.5	8.6	75	1500												
	KIT		304 210 900 113			60	22.2	8.6	75	1500		included in the KIT 314 594 300 113	inc. WLC 2.0	S	A	C	E	D	L	V	90	
	KIT		304 212 900 113			60	22.8	8.6	75	1500		included in the KIT 314 594 300 113	inc. WLC 2.0	S	A	C	E	D	L	V	90	
Vauxhall Combo Van L1 Cargo + Life inc. towball	09/18-		304 118 600 001			90	17.0	8.4	64	1600		314 594 300 113	inc. WLC 2.0	S	A	C	E	D	L	V	90	
Vauxhall Corsa Combo Van exc. vehicles with gas drive (CNG)	03/02-12/12		314 282 600 001			150	16.4	7.5	75	1200		300 072 300 107		--	FRE	--	--	--	--	--	V	
Vauxhall Corsa D exc. vehicles with bike carrier system Flex-Fix exc. VXR, exc. VXR-Line, exc. Gsi	10/06-12/14		314 306 600 001			60	17.0	7.7	55	1200		314 307 300 113		S	A	--	--	D1	--	V	90	
			314 436 600 001			60	18.5	7.7	55	1200												
	KIT		314 306 900 113			60	19.0	7.7	55	1200		included in the KIT 314 307 300 113		S	A	--	--	D1	--	V	90	
	KIT		314 307 900 113			60	20.5	7.7	55	1200		included in the KIT 314 307 300 113		S	A	--	--	D1	--	V	90	

Vauxhall





























Vauxhall















Vauxhall Corsa E exc. vehicles with bike carrier system Flex-Fix exc. VXR, exc. VXR-Line, exc. Gsi	01/15-06/19			314 306 600 001		60	17.0	7.7	55	1200		314 436 300 113	-06/19	S	CAN	--	E	D	L1	V	90
				314 436 600 001		60	18.5	7.7	55	1200											
	KIT		314 435 900 113		60	19.0	7.7	55	1200		included in the KIT 314 436 300 113	-06/19	S	CAN	--	E	D	L1	V	90	
	KIT		314 436 900 113		60	20.5	7.7	55	1200		included in the KIT 314 436 300 113	-06/19	S	CAN	--	E	D	L1	V	90	
Opel Corsa F exc. Corsa-e	06/19-			314 597 600 001		75	25.0	7.2	83	1200		314 596 300 113	without preliminary setup, exc. Corsa-e	S	CAN	C	E2	D1	L1	V	75
Opel Corsa F without preliminary setup exc. Corsa-e	06/19-	KIT		314 597 900 113		75	26.8	7.2	83	1200		included in the KIT 314 596 300 113	without preliminary setup, exc. Corsa-e	S	CAN	C	E2	D1	L1	V	75
Opel Crossland X inc. facelift 2021-	03/17-			314 583 600 001		60	23.0	6.4	78	1000		314 580 300 113	inc. WLC 2.0	S	CAN	C	E2	D1	L1	V	90
				314 584 600 001		60	24.5	6.4	78	1000											
	KIT		314 583 900 113		60	24.0	6.4	78	1000		included in the KIT 314 580 300 113	inc. WLC 2.0	S	CAN	C	E2	D1	L1	V	90	
	KIT		314 584 900 113		60	25.5	6.4	78	1000		included in the KIT 314 580 300 113	inc. WLC 2.0	S	CAN	C	E2	D1	L1	V	90	
Vauxhall Grandland X exc. Hybrid 4	07/17-			315 243 600 001		120	22.0	10.0	80	2000		314 595 300 113	inc. WLC 2.0	S	CAN	C	E2	D1	L1	V	75
				315 244 600 001		120	24.0	10.0	80	2000											
	KIT		314 590 900 113		120	23.1	10.0	80	2000		included in the KIT 314 595 300 113	inc. WLC 2.0	S	CAN	C	E2	D1	L1	V	75	
	KIT		314 591 900 113		120	26.1	10.0	80	2000		included in the KIT 314 595 300 113	inc. WLC 2.0	S	CAN	C	E2	D1	L1	V	75	

Opel Grandland X Hybrid A18 only Plugin-Hybrid	06/19-			314 599 600 001		90	26.7	8.1	95	1270		314 595 300 113			S	CAN	C	E2	D1	L1	V	75
Opel Insignia B Grand Sport exc. GSI exc. OPC inc. AdBlue	03/17-12/22			314 581 600 001		60	25.6	11.0	134	2200		314 386 300 113			S	CAN	--	E	D	L1	V	90
				314 582 600 001		60	26.4	11.0	134	2200												
		KIT		314 581 900 113		60	27.0	11.0	134	2200		included in the KIT 314 386 300 113			S	CAN	--	E	D	L1	V	90
		KIT		314 582 900 113		60	27.7	11.0	134	2200		included in the KIT 314 386 300 113			S	CAN	--	E	D	L1	V	90
Opel Insignia B Sports Tourer exc. GSI exc. Country Tourer inc. AdBlue On vehicles with automatic tailgate opening, the sensor must be repositioned. inc. facelift 2020-	06/17-12/22			314 587 600 001		60	26.6	11.0	134	2200		314 386 300 113	06/17-		S	CAN	--	E	D	L1	V	90
				314 588 600 001		60	27.8	11.0	134	2200												
		KIT		314 587 900 113		60	27.8	11.0	134	2200		included in the KIT 314 386 300 113	06/17-		S	CAN	--	E	D	L1	V	90
		KIT		314 588 900 113		60	29.0	11.0	134	2200		included in the KIT 314 386 300 113	06/17-		S	CAN	--	E	D	L1	V	90
Vauxhall Insignia Saloon exc. VXR, inc. 4x4	11/08-05/17			314 341 600 001		90	24.0	11.3	85	2100		314 386 300 113			S	CAN	--	E	D	L1	V	90
		KIT		314 341 900 113		90	25.5	11.6	85	2100		included in the KIT 314 386 300 113			S	CAN	--	E	D	L1	V	90
Vauxhall Insignia Sports Tourer 2 WD, front wheel drive exc. VXR	03/09-05/17			314 390 600 001		90	23.0	11.3	85	2100		314 342 300 113	08/09-05/17		S	CAN	--	E2	D1	L1	H	45
				314 342 600 001		90	26.5	11.3	85	2100												

Vauxhall

Vauxhall



















Vauxhall Insignia Sports Tourer 2 WD, front wheel drive exc. VXR	08/09-05/17	KIT		314 390 900 113		90	27.9	11.3	85	2100	included in the KIT 314 342 300 113	08/09-05/17	S	CAN	--	E2	D1	L1	H	45
		KIT		314 342 900 113		90	28.0	11.3	85	2100	included in the KIT 314 342 300 113	08/09-05/17	S	CAN	--	E2	D1	L1	H	45
Vauxhall Meriva exc. VXR thermal-insulation plate is necessary	05/03-05/10			314 289 600 001		60	23.0	8.3	60	1300	314 289 300 113		S	FRE	--	E1	D1	--	H	60
		KIT		314 289 900 113		60	24.0	8.3	60	1300	included in the KIT 314 289 300 113		S	FRE	--	E1	D1	--	H	60
Vauxhall Meriva exc. vehicles with bike carrier system Flex-Fix Please check if there is a towing capacity in the car documents.	06/10-03/17			314 394 600 001		60	19.0	8.3	75	1300	314 386 300 113		S	CAN	--	E	D	L1	V	90
				314 392 600 001		60	20.0	8.3	75	1300										
		KIT		314 394 900 113		60	21.0	8.3	75	1300	included in the KIT 314 386 300 113		S	CAN	--	E	D	L1	V	90
		KIT		314 392 900 113		60	22.0	8.3	75	1300	included in the KIT 314 386 300 113		S	CAN	--	E	D	L1	V	90
Vauxhall Mokka exc. vehicles with bike carrier system Flex-Fix exc. vehicles with height control exc. OPC	10/12-08/16	KIT		314 450 900 113		60	23.0	8.6	75	1400	included in the KIT 314 451 300 113	-08/16	S	A	--	E2	D	L1	V	90
		KIT		314 451 900 113		60	25.0	8.6	75	1400	included in the KIT 314 451 300 113	-08/16	S	A	--	E2	D	L1	V	90
Vauxhall Mokka exc. vehicles with bike carrier system Flex-Fix exc. vehicles with height control exc. OPC	10/12-10/20			314 511 600 001		60	21.5	8.6	75	1400	314 451 300 113	-08/16	S	A	--	E2	D	L1	V	90
				314 510 600 001		60	21.0	8.6	75	1400										
Vauxhall Mokka (B)	10/20-			314 601 600 001	→ 	60	25.8	7.2	83	1200	314 580 300 113		S	CAN	C	E2	D1	L1	V	90
		KIT		314 601 900 113		60	27.4	7.2	83	1200	included in the KIT 314 580 300 113		S	CAN	C	E2	D1	L1	V	90

Opel Vivaro C Van inc. Vivaro-e	03/19-			335 106 600 001			60	25.5	13.9	104	2500		314 585 300 113		inc. WLC 2.0 with preliminary setup inc. Vivaro-e	S	FRE	C	E	D	L1	H	75
Opel Vivaro C Van inc. Vivaro-e inc. towball	03/19-			304 190 600 001			45	26.0	13.9	104	2500		314 585 300 113		inc. WLC 2.0 with preliminary setup inc. Vivaro-e	S	FRE	C	E	D	L1	H	75
Opel Vivaro C Van inc. Vivaro-e with preliminary setup inc. towball	03/19-	KIT		314 576 900 113			45	27.7	13.9	104	2500		included in the KIT 314 585 300 113		inc. WLC 2.0 with preliminary setup inc. Vivaro-e	S	FRE	C	E	D	L1	H	75
Opel Vivaro C Van inc. Vivaro-e with preliminary setup	03/19-	KIT		314 578 900 113			60	27.2	13.9	104	2500		included in the KIT 314 585 300 113		inc. WLC 2.0 with preliminary setup inc. Vivaro-e	S	FRE	C	E	D	L1	H	75
Vauxhall Vivaro Van inc. towball	05/01-09/14			314 364 600 001	→		60	21.0	12.3	85	2100		314 860 300 113 314 870 300 113		08/06-03/10 03/10-09/14	S	FRE	--	--	D1	L1	H	60 60
Vauxhall Vivaro Van inc. towball	08/06-03/10	KIT		314 364 900 113			60	23.0	12.3	85	2100		included in the KIT 314 860 300 113		08/06-03/10	S	FRE	--	--	D1	L1	H	60
Vauxhall Vivaro Van inc. towball	03/10-09/14	KIT		314 870 900 113			60	23.0	12.3	85	2100		included in the KIT 314 870 300 113		03/10-09/14	S	FRE	--	--	D1	L1	H	60
Vauxhall Zafira inc. GSI with non-visible cut	04/99-07/05			314 270 600 001	→		150	22.8	8.9	75	1500		314 245 300 113	→		S	FRE	--	E	D1	--	V	90
Opel Zafira Life inc. Zafira-e Life	03/19-			335 106 600 001			60	25.5	13.9	104	2500		314 585 300 113		inc. WLC 2.0 with preliminary setup inc. Zafira-e Life	S	FRE	C	E	D	L1	H	75
Opel Zafira Life inc. Zafira-e Life inc. towball	03/19-			304 190 600 001			45	26.0	13.9	104	2500		314 585 300 113		inc. WLC 2.0 with preliminary setup inc. Zafira-e Life	S	FRE	C	E	D	L1	H	75
Opel Zafira Life inc. Zafira-e Life with preliminary setup inc. towball	03/19-	KIT		314 576 900 113			45	27.7	13.9	104	2500		included in the KIT 314 585 300 113		inc. WLC 2.0 with preliminary setup inc. Zafira-e Life	S	FRE	C	E	D	L1	H	75
Opel Zafira Life inc. Zafira-e Life with preliminary setup	03/19-	KIT		314 578 900 113			60	27.2	13.9	104	2500		included in the KIT 314 585 300 113		inc. WLC 2.0 with preliminary setup inc. Zafira-e Life	S	FRE	C	E	D	L1	H	75

Vauxhall

























Vauxhall

















Vauxhall Zafira Tourer exc. CNG exc. vehicles with bike carrier system Flex-Fix To guarantee an optimal fit of the bumper it is necessary to mount a polystyrene carrier, please order from Vauxhall-dealer.	01/12-06/19		314 438 600 001		60	27.0	9.9	75	1500	314 386 300 113			S	CAN	--	E	D	L1	V	90										
			314 437 600 001		60	27.0	9.9	75	1500																					
		KIT		314 438 900 113		60	28.0	9.9	75												1500	included in the KIT 314 386 300 113	S	CAN	--	E	D	L1	V	90
		KIT		314 437 900 113		60	29.0	9.9	75												1500	included in the KIT 314 386 300 113	S	CAN	--	E	D	L1	V	90
Vauxhall Zafira, Zafira Family inc. facelift 01/08- exc. CNG VXR version and vehicles with sport bumper: in addition to the visible cutout a cutout is necessary. Cover for bumper cutout not available.	07/05-04/15		314 293 600 001		75	17.5	9.6	75	1650	314 300 300 113			S	FRE	C	E	D	L1	H	45										
			KIT			314 293 900 113	75	18.5	9.6												75	1650	included in the KIT 314 300 300 113	S	FRE	C	E	D	L1	H
Vauxhall Zafira, Zafira Family exc. CNG	07/05-04/15		314 361 600 001		90	19.0	9.6	75	1650	300 210 300 113			--	A	--	E1	D1	L1	V	90										
																					314 300 300 113	for vehicles without rear central electronic (REC)	S	FRE	C	E	D	L1	H	45
		KIT		314 361 900 113		90	21.0	9.6	75	1650	included in the KIT 314 300 300 113			S	FRE	C	E	D	L1	H		45								
for vehicles with rear central electronic (REC)	S	FRE	C	E		D	L1	H	45																					

VW Amarok for vehicles with bumper with integrated step	08/10-05/20		321 831 600 001			30	7.2	15.7	140	3200		321 704 300 107	with preliminary setup	S	CAN	C	E	--	--	H	15	
												321 704 300 113	with preliminary setup	S	CAN	C	E	D	--	H	15	
VW Amarok for vehicles with bumper with integrated step towing bracket inc. Towball	08/10-05/20		321 835 600 001			30	10.0	15.7	130	3200		321 704 300 107	with preliminary setup	S	CAN	C	E	--	--	H	15	
												321 704 300 113	with preliminary setup	S	CAN	C	E	D	--	H	15	
VW Arteon	04/17-		317 140 600 001			90	15.0	11.5	100	2200		305 407 300 113	with preliminary setup	S	CAN	C	E	D	L	H	30	
												305 408 300 107	→ without preliminary setup	S	CAN	C	E	--	--	V	60	
												305 408 300 113	without preliminary setup	S	CAN	C	E	D	L	V	60	
VW Arteon without preliminary setup	04/17-	KIT		317 140 900 113			90	19.6	11.5	100	2200		included in the KIT 305 408 300 113	without preliminary setup	S	CAN	C	E	D	L	V	60
													KIT		317 141 900 113			90	19.9	11.5	100	2200
VW Arteon with preliminary setup	04/17-	KIT		317 138 900 113			90	17.0	11.5	100	2200											
													KIT		317 139 900 113			90	17.5	11.5	100	2200
VW Arteon inc. WLC 2.0 without preliminary setup	04/17-	KIT		322 004 900 113			60	26.3	10.6	125	2100											
													KIT		317 142 900 113			90	17.8	11.5	100	2200
VW Arteon inc. WLC 2.0 without preliminary setup	04/17-	KIT		317 143 900 113			90	17.4	11.5	100	2200											

Volkswagen





Volkswagen











VW Arteon Shooting Brake 3H9 inc. AdBlue inc. R-Line Please order separately: holder for antenna amplifier 917131632001	06/20-			317 140 600 001		90	15.0	11.5	100	2200		305 407 300 113	with preliminary setup	S	CAN	C	E	D	L	H	30	
				317 141 600 001		90	15.9	11.5	100	2200		305 408 300 107	→ without preliminary setup	S	CAN	C	E	--	--	V	60	
													305 408 300 113	without preliminary setup	S	CAN	C	E	D	L	V	60
														305 438 300 113	inc. WLC 2.0 without preliminary setup	S	CAN	C	E	D	L1	V
VW Arteon Shooting Brake 3H9 without preliminary setup inc. AdBlue inc. R-Line Please order separately: holder for antenna amplifier 917131632001	06/20-	KIT		317 140 900 113		90	19.6	11.5	100	2200		included in the KIT 305 408 300 113	without preliminary setup	S	CAN	C	E	D	L	V	60	
				317 143 900 113		90	17.4	11.5	100	2200		included in the KIT 305 438 300 113	inc. WLC 2.0 without preliminary setup	S	CAN	C	E	D	L1	V	90	
				317 141 900 113		90	19.9	11.5	100	2200		included in the KIT 305 408 300 113	without preliminary setup	S	CAN	C	E	D	L	V	60	
				317 142 900 113		90	17.8	11.5	100	2200		included in the KIT 305 438 300 113	inc. WLC 2.0 without preliminary setup	S	CAN	C	E	D	L1	V	90	
VW Arteon Shooting Brake 3H9 with preliminary setup inc. AdBlue inc. R-Line Please order separately: holder for antenna amplifier 917131632001	06/20-	KIT		317 138 900 113		90	17.0	11.5	100	2200		included in the KIT 305 407 300 113	with preliminary setup	S	CAN	C	E	D	L	H	30	
				317 139 900 113		90	17.5	11.5	100	2200		included in the KIT 305 407 300 113	with preliminary setup	S	CAN	C	E	D	L	H	30	
VW Bora Saloon exc. Syncro - 4-Motion	10/98-05/05			305 222 600 001		120	17.5	8.9	75	1650												
				305 223 600 001		120	16.8	8.9	75	1650		321 465 300 113		S	FRE	--	E	D1	L1	H	60	
			KIT		321 457 900 113		90	19.5	8.9	75	1650		included in the KIT 321 465 300 113		S	FRE	--	E	D1	L1	H	60
			KIT		321 465 900 113		90	18.8	8.9	75	1650		included in the KIT 321 465 300 113		S	FRE	--	E	D1	L1	H	60

VW Bora Estate exc. Syncro - 4-Motion	10/98-05/05			305 222 600 001		120	17.5	8.9	75	1650	321 457 300 113			S	FRE	--	E	D1	L1	H	60	
				305 223 600 001		120	16.8	8.9	75	1650												
		KIT		305 222 900 113		90	19.5	8.9	75	1650	included in the KIT 321 457 300 113			S	FRE	--	E	D1	L1	H	60	
		KIT		305 223 900 113		90	18.8	8.9	75	1650	included in the KIT 321 457 300 113			S	FRE	--	E	D1	L1	H	60	
VW CC	12-11/16			321 821 600 001		90	17.5	11.3	90	2200	321 600 300 113			S	FRE	C	E	D	L1	V	105	
				321 823 600 001		90	20.0	11.3	90	2200												
		KIT		321 821 900 113		90	19.5	11.3	90	2200	included in the KIT 321 600 300 113			S	FRE	C	E	D	L1	V	105	
		KIT		321 823 900 113		90	22.0	11.3	90	2200	included in the KIT 321 600 300 113			S	FRE	C	E	D	L1	V	105	
VW Caddy 4x4 / 4-Motion inc. bumper carrier inc. Caddy Cross 10/13- inc. Caddy Alltrack 16-	10/08-09/20			321 768 600 001			75	19.5	8.9	80	1500	321 554 300 107	09/10-09/20	S	CAN	C	E	--	--	V	105	
													321 554 300 113	09/10-09/20	S	CAN	C	E	D	L1	V	105
													321 557 300 107	-08/10	S	CAN	C	E	--	--	V	105
													321 557 300 113	-08/10	S	CAN	C	E	D	L1	V	105
													321 661 300 113	01/13- with preliminary setup	S	CAN	C	E	D	L1	H	30
													321 673 300 113	09/10-09/20	S	CAN	C	E	D	L1	V	105

Volkswagen





Volkswagen





VW Caddy 4x4 / 4-Motion inc. bumper carrier inc. Caddy Cross 10/13- inc. Caddy Alltrack 16- inc. towball	10/08-09/20		321 837 600 001			75	20.5	8.9	80	1500		321 554 300 107	09/10-09/20	S	CAN	C	E	--	--	V	105
												321 554 300 113	09/10-09/20	S	CAN	C	E	D	L1	V	105
												321 557 300 107	-08/10	S	CAN	C	E	--	--	V	105
												321 557 300 113	-08/10	S	CAN	C	E	D	L1	V	105
												321 661 300 113	01/13- with preliminary setup	S	CAN	C	E	D	L1	H	30
												321 673 300 113	09/10-09/20	S	CAN	C	E	D	L1	V	105
VW Caddy III + IV / Caddy Life for Caddy Maxi exc. vehicles with gas drive bracket for bumper inc. Please order at VW dealers: receptor box for detachable ball 2K0 804 969.	02/04-08/10	KIT		321 659 900 113		75	19.0	9.4	80	1650		included in the KIT 321 673 300 113	09/10-09/20	S	CAN	C	E	D	L1	V	105
												included in the KIT 321 557 300 113	-08/10	S	CAN	C	E	D	L1	V	105
VW Caddy III + IV / Caddy Life for Caddy Maxi inc. bumper carrier 5 seats: inc. vehicles with gas drive 7 seats: exc. vehicles with gas drive	02/04-08/10	KIT		321 661 900 113		75	22.5	9.4	80	1650		included in the KIT 321 557 300 113	-08/10	S	CAN	C	E	D	L1	V	105
VW Caddy III + IV / Caddy Life inc. Caddy Maxi inc. Caddy Alltrack 16- inc. bumper carrier 5 seats: inc. vehicles with gas drive 7 seats: exc. vehicles with gas drive	02/04-09/20		321 661 600 001			75	19.5	9.4	80	1650		321 554 300 107	09/10-09/20	S	CAN	C	E	--	--	V	105
												321 554 300 113	09/10-09/20	S	CAN	C	E	D	L1	V	105
												321 557 300 107	-08/10	S	CAN	C	E	--	--	V	105
												321 557 300 113	-08/10	S	CAN	C	E	D	L1	V	105
												321 661 300 113	01/13- with preliminary setup	S	CAN	C	E	D	L1	H	30
												321 673 300 113	09/10-09/20	S	CAN	C	E	D	L1	V	105
VW Caddy III + IV / Caddy Life inc. Caddy Maxi inc. Caddy Alltrack 16- exc. vehicles with gas drive bracket for bumper inc. Please order at VW dealers: receptor box for detachable ball 2K0 804 969.	02/04-09/20		321 673 600 001			75	18.0	9.4	80	1650		321 554 300 107	09/10-09/20	S	CAN	C	E	--	--	V	105
												321 554 300 113	09/10-09/20	S	CAN	C	E	D	L1	V	105
												321 557 300 107	-08/10	S	CAN	C	E	--	--	V	105
												321 557 300 113	-08/10	S	CAN	C	E	D	L1	V	105
												321 661 300 113	01/13- with preliminary setup	S	CAN	C	E	D	L1	H	30
												321 673 300 113	09/10-09/20	S	CAN	C	E	D	L1	V	105

VW Caddy III + IV / Caddy Life inc. Caddy Maxi inc. Caddy Alltrack 16- inc. bumper carrier 5 seats: inc. vehicles with gas drive 7 seats: exc. vehicles with gas drive	09/10-09/20	KIT		321 554 900 113			75	21.5	9.4	80	1650			included in the KIT 321 554 300 113	09/10-09/20	S	CAN	C	E	D	L1	V	105
VW Caddy III + IV / Caddy Life inc. Caddy Maxi inc. Caddy Alltrack 16- exc. vehicles with gas drive bracket for bumper inc. Please order at VW dealers: receptor box for detachable ball 2K0 804 969.	09/10-09/20	KIT		321 660 900 113			75	20.0	9.4	80	1650			included in the KIT 321 554 300 113	09/10-09/20	S	CAN	C	E	D	L1	V	105
VW Caddy V	09/20-		 	322 088 600 001 322 089 600 001			90	20.0	9.8	119	1620		322 088 300 113 322 089 300 113 322 092 300 113	09/20- with preliminary setup 09/20- without preliminary setup 09/20- without preliminary setup, inc. WLC 2.0	S	CAN	C	E	D	L	H	30	
VW Caddy V for vehicles without preliminary setup	09/20-	KIT		322 088 900 113			90	22.0	9.8	119	1620		included in the KIT 322 092 300 113	09/20- without preliminary setup, inc. WLC 2.0	S	CAN	C	E	D	L	V	90	
		KIT		322 089 900 113			90	25.0	9.8	119	1620		included in the KIT 322 092 300 113	09/20- without preliminary setup, inc. WLC 2.0	S	CAN	C	E	D	L	V	90	
VW Caddy V for vehicles with preliminary setup	09/20-	KIT		322 086 900 113			90	21.5	9.8	119	1620		included in the KIT 322 088 300 113	09/20- with preliminary setup	S	CAN	C	E	D	L	H	30	
		KIT		322 087 900 113			90	24.5	9.8	119	1620		included in the KIT 322 088 300 113	09/20- with preliminary setup	S	CAN	C	E	D	L	H	30	
VW Crafter Van without preliminary setup types 30/35/38 Vehicles with 3,0 and 3,5 t max. total weight, increase to 3,8 t max. total weight is possible For vehicles with integrated step device in the bumper the middle part of the outer bumper must be exchanged (Please order separately at VW dealers.). inc. towball Step VW is not utilisable. Utilisable step: 313285600001 or 313440600001	04/06-12/14	KIT		313 376 900 113			120	22.0	18.1	150	3500		included in the KIT 313 105 300 113	-12/14for vehicles without preparation	S	CAN	C	E	D1	--	V	90	





Volkswagen







Volkswagen

VW Crafter Van types 46 and 50 Vehicles with 5,0 t max. total weight, reduction to 4,6 t max. total weight is possible wheelbase: 3665 mm For vehicles with integrated step device in the bumper the middle part of the outer bumper must be exchanged (Please order at VW dealers.). towball: 329141600001 Step VW is not utilisable. Utilisable step: 313285600001 or 313440600001	04/06-12/16			313 272 600 001		120	22.0	20.2	150	3500		313 105 300 107	→	-12/14 for vehicles without preparation	S	CAN	C	E	--	--	V	90
												313 105 300 113		-12/14for vehicles without preparation	S	CAN	C	E	D1	--	V	90
												313 107 300 113		01/15- for vehicles with preparation	S	CAN	C	E	D1	L1	H	45
												313 108 300 113		01/15- for vehicles without preparation	S	CAN	C	E	D1	L1	V	90
												321 106 300 113		-12/14 vehicles with preparation	S	CAN	C	E	D	--	H	45
VW Crafter Van types 46 and 50 Vehicles with 5,0 t max. total weight, reduction to 4,6 t max. total weight is possible wheelbase: 4325 mm For vehicles with integrated step device in the bumper the middle part of the outer bumper must be exchanged (Please order at VW dealers.). towball: 329141600001 Step VW is not utilisable. Utilisable step: 313285600001 or 313440600001	04/06-12/16			313 273 600 001		120	23.0	20.2	150	3500		313 105 300 107	→	-12/14 for vehicles without preparation	S	CAN	C	E	--	--	V	90
												313 105 300 113		-12/14for vehicles without preparation	S	CAN	C	E	D1	--	V	90
												313 107 300 113		01/15- for vehicles with preparation	S	CAN	C	E	D1	L1	H	45
												313 108 300 113		01/15- for vehicles without preparation	S	CAN	C	E	D1	L1	V	90
												321 106 300 113		-12/14 vehicles with preparation	S	CAN	C	E	D	--	H	45
VW Crafter Van types 30/35/38 Vehicles with 3,0 and 3,5 t max. total weight, increase to 3,8 t max. total weight is possible Only for cars without step. For cars with step order 313553600001. Suitable towball: 329141600001 Step VW is not utilisable.	04/06-12/16			313 376 600 001		120	20.0	18.1	150	3500		313 105 300 107	→	-12/14 for vehicles without preparation	S	CAN	C	E	--	--	V	90
												313 105 300 113		-12/14for vehicles without preparation	S	CAN	C	E	D1	--	V	90
												313 107 300 113		01/15- for vehicles with preparation	S	CAN	C	E	D1	L1	H	45
												313 108 300 113		01/15- for vehicles without preparation	S	CAN	C	E	D1	L1	V	90
												321 106 300 113		-12/14 vehicles with preparation	S	CAN	C	E	D	--	H	45





























VW Crafter Van without preliminary setup types 30/35/38 Vehicles with 3,0 and 3,5 t max. total weight, increase to 3,8 t max. total weight is possible For vehicles with integrated step device in the bumper the middle part of the outer bumper must be exchanged (Please order separately at VW dealers.). inc. towball Step VW is not utilisable. Utilisable step: 313285600001 or 313440600001	01/15-12/16	KIT		313 108 900 113			120	23.0	18.1	150	3500				included in the KIT 313 108 300 113		01/15- for vehicles without preparation	S	CAN	C	E	D1	L1	V	90
VW Crafter Van singel wheels Please order separately ball plate: 329141600001 exc. vehicles with integrated step in the bumper Please replace underrun protection if necessary. exc. e-Crafter	01/17-			321 946 600 001			30	26.7	17.5	150	3500				321 112 300 113		with preliminary setup	S	CAN	--	E	D	L	V	15
															321 113 300 107		without preliminary setup	S	CAN	C	E	--	--	V	60
															321 113 300 113		without preliminary setup	S	CAN	C	E	D	L	V	60
VW Crafter Van twin wheels Please order separately ball plate 329141600001 exc. vehicles with integrated step in the bumper Please replace underrun protection if necessary. exc. e-Crafter	01/17-			321 947 600 001			30	27.0	21.0	150	3500				321 112 300 113		with preliminary setup	S	CAN	--	E	D	L	V	15
															321 113 300 107		without preliminary setup	S	CAN	C	E	--	--	V	60
															321 113 300 113		without preliminary setup	S	CAN	C	E	D	L	V	60
VW Crafter Van without preliminary setup twin wheels inc. ball plate exc. vehicles with integrated step in the bumper Please replace underrun protection if necessary. e-Crafter	01/17-	KIT		321 947 900 113			30	30.0	21.0	150	3500				included in the KIT 321 113 300 113		without preliminary setup	S	CAN	C	E	D	L	V	60
VW Crafter Van without preliminary setup single wheels inc. ball plate exc. vehicles with integrated step in the bumper Please replace underrun protection if necessary. exc. e-Crafter	01/17-	KIT		321 946 900 113			30	28.5	17.5	150	3500				included in the KIT 321 113 300 113		without preliminary setup	S	CAN	C	E	D	L	V	60

























Volkswagen

VW Crafter Van singel wheels inc. ball plate only vehicles with integrated step in the bumper exc. e-Crafter	01/17-		322 011 600 001			60	29.7	15.8	120	3000		321 112 300 113	with preliminary setup	S	CAN	--	E	D	L	V	15
												321 113 300 107	without preliminary setup	S	CAN	C	E	--	--	V	60
												321 113 300 113	without preliminary setup	S	CAN	C	E	D	L	V	60
VW Crafter Chassis Cab without preliminary setup types 46 and 50 Vehicles with 5,0 t max. total weight, reduction to 4,6 t max. total weight is possible wheelbase: 3665 + 4325 mm towball inc. If there is an underrun guard mounted, please change into VW no. 2E3 805 721 A.	04/06-12/14	KIT 	313 275 900 113			90	20.0	20.2	150	3500		included in the KIT 313 105 300 113	-12/14 for vehicles without preparation	S	CAN	C	E	D1	--	V	90
VW Crafter Chassis Cab without preliminary setup types 30/35/38 Vehicles with 3,0 and 3,5 t max. total weight, increase to 3,8 t max. total weight is possible exc. vehicles with underrun guard inc. towball	04/06-12/14	KIT 	313 377 900 113	→		90	22.0	18.1	150	3500		included in the KIT 313 105 300 113	-12/14 for vehicles without preparation	S	CAN	C	E	D1	--	V	90
VW Crafter Chassis Cab without preliminary setup types 30/35/38 Vehicles with 3,0 and 3,5 t max. total weight, increase to 3,8 t max. total weight is possible exc. vehicles with underrun guard inc. towball 329080600001	04/06-12/14	KIT 	313 522 900 113			60	21.8	20.2	240	3500		included in the KIT 313 105 300 113	-12/14 for vehicles without preparation	S	CAN	C	E	D1	--	V	90
VW Crafter Chassis Cab types 46 and 50 Vehicles with 5,0 t max. total weight, reduction to 4,6 t max. total weight is possible wheelbase: 3665 + 4325 mm towball: 329059600001 If there is an underrun guard mounted, please change into VW no. 2E3 805 721 A.	04/06-12/16		313 275 600 001			90	18.0	20.2	150	3500		313 105 300 107	→ -12/14 for vehicles without preparation	S	CAN	C	E	--	--	V	90
												313 105 300 113	-12/14 for vehicles without preparation	S	CAN	C	E	D1	--	V	90
												313 107 300 113	01/15- for vehicles with preparation	S	CAN	C	E	D1	L1	H	45
												313 108 300 113	01/15- for vehicles without preparation	S	CAN	C	E	D1	L1	V	90
												321 106 300 113	-12/14 vehicles with preparation	S	CAN	C	E	D	--	H	45





VW Crafter Chassis Cab types 30/35/38 Vehicles with 3,0 and 3,5 t max. total weight, increase to 3,8 t max. total weight is possible exc. vehicles with underrun guard towball: 329059600001	04/06-12/16		313 377 600 001 →		90	20.0	18.1	150	3500		313 105 300 107 →	-12/14 for vehicles without preparation	S	CAN	C	E	--	--	V	90	
												313 105 300 113	-12/14 for vehicles without preparation	S	CAN	C	E	D1	--	V	90
												313 107 300 113	01/15- for vehicles with preparation	S	CAN	C	E	D1	L1	H	45
												313 108 300 113	01/15- for vehicles without preparation	S	CAN	C	E	D1	L1	V	90
												321 106 300 113	-12/14 vehicles with preparation	S	CAN	C	E	D	--	H	45
VW Crafter Chassis Cab types 30/35/38 Vehicles with 3,0 and 3,5 t max. total weight, increase to 3,8 t max. total weight is possible exc. vehicles with underrun guard inc. towball	04/06-12/16		313 522 600 001		60	19.6	20.2	240	3500		313 105 300 113	-12/14 for vehicles without preparation	S	CAN	C	E	D1	--	V	90	
VW Crafter Chassis Cab without preliminary setup types 30/35/38 Vehicles with 3,0 and 3,5 t max. total weight, increase to 3,8 t max. total weight is possible exc. vehicles with underrun guard inc. towball 329080600001	01/15-12/16	KIT 	313 107 900 113		60	22.9	20.2	240	3500		included in the KIT 313 108 300 113	01/15- for vehicles without preparation	S	CAN	C	E	D1	L1	V	90	
VW Crafter Chassis Cab singel wheels Please order separately ball plate 329141600001. exc. e-Crafter	01/17-		321 948 600 001		30	22.0	21.0	150	3500		321 112 300 113	with preliminary setup	S	CAN	--	E	D	L	V	15	
											321 113 300 107	without preliminary setup	S	CAN	C	E	--	--	V	60	
											321 113 300 113	without preliminary setup	S	CAN	C	E	D	L	V	60	
VW Crafter Chassis Cab without preliminary setup single wheels inc. ball plate exc. e-Crafter	01/17-	KIT 	321 948 900 113		30	26.5	21.0	150	3500		included in the KIT 321 113 300 113	without preliminary setup	S	CAN	C	E	D	L	V	60	
VW Eos Coupé/Convertible Please order spoiler inc. cover for bumper cutout at VW-dealers. inc. facelift 01/11-	06/06-12/15		321 543 600 001		75	18.0	9.3	100	1800		321 600 300 113		S	FRE	C	E	D	L1	V	105	











Volkswagen

VW Golf IV Hatchback exc. Syncro - 4-Motion and convertible exc. Golf R32 / 241 PS	10/97-10/03		305 222 600 001		120	17.5	8.9	75	1650		321 465 300 113	-10/03	S	FRE	--	E	D1	L1	H	60
			305 223 600 001		120	16.8	8.9	75	1650											
	KIT		321 457 900 113		90	19.5	8.9	75	1650		included in the KIT 321 465 300 113	-10/03	S	FRE	--	E	D1	L1	H	60
	KIT		321 465 900 113		90	18.8	8.9	75	1650		included in the KIT 321 465 300 113	-10/03	S	FRE	--	E	D1	L1	H	60
VW Golf IV Estate exc. Syncro - 4-Motion and convertible exc. Golf R32 / 241 PS	10/97-05/07		305 222 600 001		120	17.5	8.9	75	1650		321 457 300 113	-05/07	S	FRE	--	E	D1	L1	H	60
			305 223 600 001		120	16.8	8.9	75	1650											
	KIT		305 222 900 113		90	19.5	8.9	75	1650		included in the KIT 321 457 300 113	-05/07	S	FRE	--	E	D1	L1	H	60
	KIT		305 223 900 113		90	18.8	8.9	75	1650		included in the KIT 321 457 300 113	-05/07	S	FRE	--	E	D1	L1	H	60
VW Golf V Saloon exc. R/RS32 09/05- exc. R/R20 / 270 HP 09- inc. 4-Motion / Gti	11/03-09/08		321 865 600 001		60	17.0	9.4	100	1800		321 600 300 113	-09/08	S	FRE	C	E	D	L1	V	105
		KIT		321 750 900 113		60	18.5	9.4	100	1800										
VW Golf V Saloon exc. R/RS32 09/05- exc. R/R20 / 270 HP 09- inc. 4-Motion / Gti Please order separately: spoiler and cover for bumper cutout at VW dealers.	11/03-09/08		321 885 600 001		60	17.0	9.4	100	1800		321 600 300 113	-09/08	S	FRE	C	E	D	L1	V	105
		KIT		321 751 900 113		60	18.5	9.4	100	1800										
VW Golf V Hatchback and Plus inc. Cross-Golf exc. RS32 09/05- exc. R20 / 270 HP 09- inc. 4-Motion / Gti	03/05-02/09		321 865 600 001		60	17.0	9.4	100	1800		321 600 300 113	-02/09	S	FRE	C	E	D	L1	V	105
		KIT		321 750 900 113		60	18.5	9.4	100	1800										



















VW Golf V Hatchback and Plus inc. Cross-Golf exc. RS32 09/05- exc. R20 / 270 HP 09- inc. 4-Motion / Gti Please order separately: spoiler and cover for bumper cutout at VW dealers.	03/05-02/09		321 885 600 001		60	17.0	9.4	100	1800		321 600 300 113	-02/09	S	FRE	C	E	D	L1	V	105
		KIT		321 751 900 113		60	18.5	9.4	100	1800		included in the KIT 321 600 300 113	-02/09	S	FRE	C	E	D	L1	V
VW Golf V Estate inc. 4-Motion Please order spoiler at VW dealers.	06/07-05/09		321 630 600 001		90	17.0	9.3	100	1800		321 600 300 113	-05/09	S	FRE	C	E	D	L1	V	105
		KIT		321 630 900 113		90	21.0	9.3	100	1800		included in the KIT 321 600 300 113	-05/09	S	FRE	C	E	D	L1	V
VW Golf V Estate inc. 4-Motion	06/07-05/09		321 662 600 001		90	17.0	9.3	100	1800		321 600 300 113	-05/09	S	FRE	C	E	D	L1	V	105
		KIT		321 662 900 113		90	19.0	9.3	100	1800		included in the KIT 321 600 300 113	-05/09	S	FRE	C	E	D	L1	V
VW Golf VI Convertible cutout with stencil, alternative: spoiler + cover for cutout from VW dealers	06/11-05/16		321 873 600 001		60	17.0	9.4	75	1800		305 256 300 113	-05/16	S	CAN	C	E	D1	--	V	120
		KIT		321 730 900 113		60	19.0	9.4	75	1800		included in the KIT 305 256 300 113	-05/16	S	CAN	C	E	D1	--	V
VW Golf VI Saloon exc. R/RS32 09/05- exc. R/R20 / 270 HP 09- inc. 4-Motion / Gti	10/08-09/12		321 865 600 001		60	17.0	9.4	100	1800		321 600 300 113	-09/12	S	FRE	C	E	D	L1	V	105
		KIT		321 750 900 113		60	18.5	9.4	100	1800		included in the KIT 321 600 300 113	-09/12	S	FRE	C	E	D	L1	V
VW Golf VI Saloon exc. R/RS32 09/05- exc. R/R20 / 270 HP 09- inc. 4-Motion / Gti Please order separately: spoiler and cover for bumper cutout at VW dealers.	10/08-09/12		321 885 600 001		60	17.0	9.4	100	1800		321 600 300 113	-09/12	S	FRE	C	E	D	L1	V	105
		KIT		321 751 900 113		60	18.5	9.4	100	1800		included in the KIT 321 600 300 113	-09/12	S	FRE	C	E	D	L1	V























Volkswagen

VW Golf VI Hatchback and Plus inc. Cross-Golf exc. RS32 09/05- exc. R20 / 270 HP 09- inc. 4-Motion / Gti	03/09-12/13			321 865 600 001		60	17.0	9.4	100	1800		321 600 300 113	-12/13	S	FRE	C	E	D	L1	V	105
		KIT		321 750 900 113		60	18.5	9.4	100	1800		included in the KIT 321 600 300 113	-12/13	S	FRE	C	E	D	L1	V	105
VW Golf VI Hatchback and Plus inc. Cross-Golf exc. RS32 09/05- exc. R20 / 270 HP 09- inc. 4-Motion / Gti Please order separately: spoiler and cover for bumper cutout at VW dealers.	03/09-12/13			321 885 600 001		60	17.0	9.4	100	1800		321 600 300 113	-12/13	S	FRE	C	E	D	L1	V	105
		KIT		321 751 900 113		60	18.5	9.4	100	1800		included in the KIT 321 600 300 113	-12/13	S	FRE	C	E	D	L1	V	105
VW Golf VI Estate inc. 4-Motion Please order spoiler at VW dealers.	06/09-07/13			321 630 600 001		90	17.0	9.3	100	1800		321 600 300 113	-07/13	S	FRE	C	E	D	L1	V	105
		KIT		321 630 900 113		90	21.0	9.3	100	1800		included in the KIT 321 600 300 113	-07/13	S	FRE	C	E	D	L1	V	105
VW Golf VI Estate inc. 4-Motion	06/09-07/13			321 662 600 001		90	17.0	9.3	100	1800		321 600 300 113	-07/13	S	FRE	C	E	D	L1	V	105
		KIT		321 662 900 113		90	19.0	9.3	100	1800		included in the KIT 321 600 300 113	-07/13	S	FRE	C	E	D	L1	V	105
VW Golf VII Hatchback (AU) without preliminary setup exc. e-Golf	10/12-06/14	KIT		317 131 900 113		60	21.0	10.3	85	2000		included in the KIT 305 406 300 113	-06/14 without preliminary setup	S	CAN	C	E	D	L1	V	150
VW Golf VII Hatchback (AU) without preliminary setup exc.e-Golf Please order spoiler inc. cover for bumper cutout at VW-dealers.	10/12-06/14	KIT		317 132 900 113		60	21.0	10.3	85	2000		included in the KIT 305 406 300 113	-06/14 without preliminary setup	S	CAN	C	E	D	L1	V	150

VW Golf VII Hatchback (AU) exc.e-Golf, GTI TCR, GTI Clubsport	10/12-07/19		317 131 600 001		60	19.0	10.3	85	2000	305 403 300 113	-06/14 with preliminary setup	S	CAN	C	E	D	L1	H	45	
										305 406 300 113	-06/14 without preliminary setup	S	CAN	C	E	D	L1	V	150	
										305 407 300 113	06/14-07/19 with preliminary setup	S	CAN	C	E	D	L	H	30	
										305 408 300 107 →	06/14-07/19 without preliminary setup	S	CAN	C	E	--	--	V	60	
										305 408 300 113	06/14-07/19 without preliminary setup	S	CAN	C	E	D	L	V	60	
VW Golf VII Hatchback (AU) exc.e-Golf, GTI TCR, GTI Clubsport Please order spoiler inc. cover for bumper cutout at VW-dealers.	10/12-07/19		317 132 600 001		60	19.0	10.3	85	2000	305 403 300 113	-06/14 with preliminary setup	S	CAN	C	E	D	L1	H	45	
										305 406 300 113	-06/14 without preliminary setup	S	CAN	C	E	D	L1	V	150	
										305 407 300 113	06/14-07/19 with preliminary setup	S	CAN	C	E	D	L	H	30	
										305 408 300 107 →	06/14-07/19 without preliminary setup	S	CAN	C	E	--	--	V	60	
										305 408 300 113	06/14-07/19 without preliminary setup	S	CAN	C	E	D	L	V	60	
VW Golf VII Hatchback (AU) without preliminary setup exc. e-Golf, GTI TCR, GTI Clubsport	10/12-07/19	KIT		305 418 900 113		60	20.9	10.3	85	2000	included in the KIT 305 438 300 113	inc. WLC 2.0 without preliminary setup	S	CAN	C	E	D	L1	V	90
VW Golf VII Hatchback (AU) without preliminary setup exc. e-Golf, GTI TCR, GTI Clubsport Please order spoiler inc. cover for bumper cutout at VW-dealers.	10/12-07/19	KIT		305 419 900 113		60	20.9	10.3	85	2000	included in the KIT 305 438 300 113	inc. WLC 2.0 without preliminary setup	S	CAN	C	E	D	L1	V	90
VW Golf VII Hatchback (AU) without preliminary setup exc. e-Golf, GTI TCR, GTI Clubsport	06/14-07/19	KIT		305 408 900 113		60	19.0	10.3	85	2000	included in the KIT 305 408 300 113	06/14-07/19 without preliminary setup	S	CAN	C	E	D	L	V	60



























Volkswagen

VW Golf VII Hatchback (AU) without preliminary setup exc. e-Golf, GTI TCR, GTI Clubsport Please order spoiler inc. cover for bumper cutout at VW-dealers.	06/14-07/19	KIT		305 409 900 113		60	21.0	10.3	85	2000		included in the KIT 305 408 300 113		06/14-07/19 without preliminary setup	S	CAN	C	E	D	L	V	60
VW Golf VII Hatchback (AU) with preliminary setup exc.e-Golf, GTI TCR, GTI Clubsport Please order spoiler inc. cover for bumper cutout at VW-dealers.	06/14-07/19	KIT		317 155 900 113		60	20.5	10.3	85	2000		included in the KIT 305 407 300 113		06/14-07/19 with preliminary setup	S	CAN	C	E	D	L	H	30
VW Golf VII Hatchback (AU) with preliminary setup exc.e-Golf, GTI TCR, GTI Clubsport	06/14-07/19	KIT		317 154 900 113		60	20.5	10.3	85	2000		included in the KIT 305 407 300 113		06/14-07/19 with preliminary setup	S	CAN	C	E	D	L	H	30
VW Golf VII Sportsvan AM1	06/14-06/20			317 131 600 001		60	19.0	10.3	85	2000		305 407 300 113		with preliminary setup	S	CAN	C	E	D	L	H	30
												305 408 300 107	→	without preliminary setup	S	CAN	C	E	--	--	V	60
												305 408 300 113		without preliminary setup	S	CAN	C	E	D	L	V	60
VW Golf VII Sportsvan AM1 Please order spoiler inc. cover for bumper cutout at VW-dealers.	06/14-06/20			317 132 600 001		60	19.0	10.3	85	2000		305 407 300 113		with preliminary setup	S	CAN	C	E	D	L	H	30
												305 408 300 107	→	without preliminary setup	S	CAN	C	E	--	--	V	60
												305 408 300 113		without preliminary setup	S	CAN	C	E	D	L	V	60
VW Golf VII Sportsvan AM1 without preliminary setup	06/14-06/20	KIT		305 408 900 113		60	19.0	10.3	85	2000		included in the KIT 305 408 300 113		without preliminary setup	S	CAN	C	E	D	L	V	60
		KIT		305 418 900 113		60	20.9	10.3	85	2000		included in the KIT 305 438 300 113		inc. WLC 2.0 without preliminary setup	S	CAN	C	E	D	L1	V	90
VW Golf VII Sportsvan AM1 without preliminary setup Please order spoiler inc. cover for bumper cutout at VW-dealers.	06/14-06/20	KIT		305 409 900 113		60	21.0	10.3	85	2000		included in the KIT 305 408 300 113		without preliminary setup	S	CAN	C	E	D	L	V	60
		KIT		305 419 900 113		60	20.9	10.3	85	2000		included in the KIT 305 438 300 113		inc. WLC 2.0 without preliminary setup	S	CAN	C	E	D	L1	V	90





















VW Golf VII Sportsvan AM1 with preliminary setup Please order spoiler inc. cover for bumper cutout at VW-dealers.	06/14-06/20	KIT		317 155 900 113		60	20.5	10.3	85	2000		included in the KIT 305 407 300 113		with preliminary setup	S	CAN	C	E	D	L	H	30
VW Golf VII Sportsvan AM1 with preliminary setup	06/14-06/20	KIT		317 154 900 113		60	20.5	10.3	85	2000		included in the KIT 305 407 300 113		with preliminary setup	S	CAN	C	E	D	L	H	30
VW Golf VII Estate				321 782 600 001		60	17.0	10.2	80	2000												
VW Golf VII Estate without preliminary setup inc. 4 Motion	08/13-06/14	KIT		321 781 900 113		60	18.0	10.2	80	2000		included in the KIT 305 406 300 113		-06/14 without preliminary setup	S	CAN	C	E	D	L1	V	150
		KIT		321 782 900 113		60	19.0	10.2	80	2000		included in the KIT 305 406 300 113		-06/14 without preliminary setup	S	CAN	C	E	D	L1	V	150
VW Golf VII Estate inc. 4 Motion inc. Alltrack 02/15-	08/13-08/20			321 781 600 001		60	16.0	10.2	80	2000		305 403 300 113		-06/14 with preliminary setup	S	CAN	C	E	D	L1	H	45
				321 782 600 001		60	17.0	10.2	80	2000		305 406 300 113		-06/14 without preliminary setup	S	CAN	C	E	D	L1	V	150
												305 407 300 113		06/14- with preliminary setup	S	CAN	C	E	D	L	H	30
												305 408 300 107	→	06/14- without preliminary setup	S	CAN	C	E	--	--	V	60
												305 408 300 113		06/14- without preliminary setup	S	CAN	C	E	D	L	V	60
VW Golf VII Estate without preliminary setup inc. 4-Motion inc. Alltrack 02/15-	08/13-08/20	KIT		321 787 900 113		60	17.9	10.2	80	2000		included in the KIT 305 438 300 113		inc. WLC 2.0 without preliminary setup	S	CAN	C	E	D	L1	V	90
		KIT		321 786 900 113		60	18.9	10.2	80	2000		included in the KIT 305 438 300 113		inc. WLC 2.0 without preliminary setup	S	CAN	C	E	D	L1	V	90
VW Golf VII Estate without preliminary setup inc. 4 Motion inc. Alltrack 02/15-	06/14-08/20	KIT		321 783 900 113		60	18.0	10.2	80	2000		included in the KIT 305 408 300 113		06/14- without preliminary setup	S	CAN	C	E	D	L	V	60
		KIT		321 784 900 113		60	19.0	10.2	80	2000		included in the KIT 305 408 300 113		06/14- without preliminary setup	S	CAN	C	E	D	L	V	60





















Volkswagen

















Volkswagen

VW Golf VIII Hatchback CD1 exc. GTI Clubsport Please order separately: holder for antenna amplifier 917131632001	07/19-			317 131 600 001		60	19.0	10.3	85	2000		322 080 300 113	without preliminary setup	S	CAN	C	E	D	L	V	120
				317 132 600 001		60	19.0	10.3	85	2000		322 081 300 113	with preliminary setup	S	CAN	C	E	D	L	H	45
VW Golf VIII Hatchback CD1 without preliminary setup exc. GTI Clubsport Please order separately: holder for antenna amplifier 917131632001	07/19-	KIT		322 080 900 113		60	21.0	10.3	85	2000		included in the KIT 322 080 300 113	without preliminary setup	S	CAN	C	E	D	L	V	120
				322 081 900 113		60	21.0	10.3	85	2000		included in the KIT 322 080 300 113	without preliminary setup	S	CAN	C	E	D	L	V	120
VW Golf VIII Hatchback CD1 inc. AdBlue inc. Hybrid exc. GTI Clubsport exc. R-Line Model style: Please change spoiler.	07/19-			322 093 600 001		60	17.7	12.3	150	2500		322 080 300 113	without preliminary setup	S	CAN	C	E	D	L	V	120
				322 094 600 001		60	17.7	12.3	150	2500		322 081 300 113	with preliminary setup	S	CAN	C	E	D	L	H	45
VW Golf VIII Hatchback CD1 without preliminary setup inc. AdBlue inc. Hybrid exc. GTI Clubsport exc. R-Line Model style: Please change spoiler.	07/19-	KIT		322 093 900 113		60	19.6	12.3	150	2500		included in the KIT 322 080 300 113	without preliminary setup	S	CAN	C	E	D	L	V	120
				322 094 900 113		60	19.6	12.3	150	2500		included in the KIT 322 080 300 113	without preliminary setup	S	CAN	C	E	D	L	V	120
VW Golf IV Estate CG5 without preliminary setup inc. AdBlue inc. Hybrid	08/20-	KIT		322 093 900 113		60	19.6	12.3	150	2500		included in the KIT 322 080 300 113	without preliminary setup	S	CAN	C	E	D	L	V	120
				322 094 900 113		60	19.6	12.3	150	2500		included in the KIT 322 080 300 113	without preliminary setup	S	CAN	C	E	D	L	V	120
VW Golf IV Estate CG5 inc. AdBlue inc. Hybrid	08/20-			322 093 600 001		60	17.7	12.3	150	2500		322 080 300 113	without preliminary setup	S	CAN	C	E	D	L	V	120
				322 094 600 001		60	17.7	12.3	150	2500		322 081 300 113	with preliminary setup	S	CAN	C	E	D	L	H	45
VW ID.4 E21	05/20-			322 091 600 001		60	18.2	9.1	100	1400		322 090 300 113	05/20- without preliminary setup	S	CAN	C	E	D	L	V	75

Volkswagen





















VW Passat Saloon inc. 4-Motion exc. R36 Please order additionally lower part of the bumper with cover for bumper cutout at VW dealer.	03/05-10/10			321 546 600 001		90	17.5	11.3	90	2200		321 600 300 113			S	FRE	C	E	D	L1	V	105
		KIT		321 546 900 113		90	21.0	11.3	90	2200		included in the KIT 321 600 300 113			S	FRE	C	E	D	L1	V	105
VW Passat Saloon B7 R-Line = visible cut	10/10-11/14			321 821 600 001		90	17.5	11.3	90	2200		321 600 300 113			S	FRE	C	E	D	L1	V	105
				321 823 600 001		90	20.0	11.3	90	2200						S	FRE	C	E	D	L1	V
		KIT		321 821 900 113		90	19.5	11.3	90	2200		included in the KIT 321 600 300 113			S	FRE	C	E	D	L1	V	105
		KIT		321 823 900 113		90	22.0	11.3	90	2200		included in the KIT 321 600 300 113			S	FRE	C	E	D	L1	V	105
VW Passat Saloon B8 with preliminary setup Please order separately: holder for antenna amplifier 917131632001	11/14-	KIT		317 138 900 113		90	17.0	11.5	100	2200		included in the KIT 305 407 300 113		-12/21 with preliminary setup	S	CAN	C	E	D	L	H	30
		KIT		317 139 900 113		90	17.5	11.5	100	2200		included in the KIT 305 407 300 113		-12/21 with preliminary setup	S	CAN	C	E	D	L	H	30
VW Passat Saloon B8 Please order separately: holder for antenna amplifier 917131632001	11/14-12/21			317 140 600 001		90	15.0	11.5	100	2200		305 407 300 113		-12/21 with preliminary setup	S	CAN	C	E	D	L	H	30
				317 141 600 001		90	15.9	11.5	100	2200		305 408 300 107	→	-12/21 without preliminary setup	S	CAN	C	E	--	--	V	60
												305 408 300 113		-12/21 without preliminary setup	S	CAN	C	E	D	L	V	60
												305 438 300 113		-12/21 inc. WLC 2.0 without preliminary setup	S	CAN	C	E	D	L1	V	90









VW Passat Saloon B8 without preliminary setup Please order separately: holder for antenna amplifier 917131632001	11/14-12/21	KIT		317 140 900 113		90	19.6	11.5	100	2200		included in the KIT 305 408 300 113	-12/21 without preliminary setup	S	CAN	C	E	D	L	V	60	
		KIT		317 143 900 113		90	17.4	11.5	100	2200		included in the KIT 305 438 300 113	-12/21 inc. WLC 2.0 without preliminary setup	S	CAN	C	E	D	L1	V	90	
		KIT		317 141 900 113		90	19.9	11.5	100	2200		included in the KIT 305 408 300 113	-12/21 without preliminary setup	S	CAN	C	E	D	L	V	60	
		KIT		317 142 900 113		90	17.8	11.5	100	2200		included in the KIT 305 438 300 113	-12/21 inc. WLC 2.0 without preliminary setup	S	CAN	C	E	D	L1	V	90	
VW Passat Estate front wheel drive exc. 4-Motion from 11/00: To guarantee an optimal fit of the bumper it is necessary to mount a bumper reinforcement, please order from VW-dealer, order no. 3B9 807 251A Support for detachable towball in spare wheel: 3B0 804 993A	04/97-09/05			321 505 600 001		90	20.8	10.3	85	1800		321 520 300 113	11/00-	S	FRE	--	E	D1	L1	V	60	
VW Passat Estate front wheel drive exc. 4-Motion from 11/00: To guarantee an optimal fit of the bumper it is necessary to mount a bumper reinforcement, please order from VW-dealer, order no. 3B9 807 251A Support for detachable towball in spare wheel: 3B0 804 993A	11/00-09/05	KIT		321 505 900 113		90	24.0	10.3	85	2000		included in the KIT 321 520 300 113	11/00-	S	FRE	--	E	D1	L1	V	60	
VW Passat Estate inc. 4-Motion, inc. R36 08/05-: To guarantee an optimal fit of the bumper order bumper reinforcement from VW-dealer order no. 3C9 807 251 A.	09/05-10/10			321 544 600 001		90	16.0	11.3	90	2200		321 600 300 113		S	FRE	C	E	D	L1	V	105	
				321 546 600 001		90	17.5	11.3	90	2200												
		KIT		321 544 900 113		90	18.0	12.3	90	2200		included in the KIT 321 600 300 113		S	FRE	C	E	D	L1	V	105	
		KIT		321 546 900 113		90	21.0	11.3	90	2200		included in the KIT 321 600 300 113		S	FRE	C	E	D	L1	V	105	

VW Phaeton Please order from VW dealer: Spoiler V6 Petrol + V 8: 3D5 807 434 F Spoiler V6 Diesel + V10: 3D5 807 434 H Spoiler: V12: 3D5 807 434 G cover for bumper: 3D5 807 397 A V7S clip (2x): 6Q0 807 180 bracket to mount towball in the boot consisting of: bracket:	05/02-01/16			321 525 600 001		90	26.0	13.6	100	2500		321 495 300 113	11/08-	S	CAN	C	E	D	L1	H	60
VW Polo inc. R-Line If desired for optical reasons, it is possible to get the complete bumper inc. cover at VW dealers. R-Line: extension for socket holder necessary, order no. 921740650001	06/09-04/14	KIT		321 741 900 113		120	17.0	7.0	50	1200		included in the KIT 321 527 300 113	-04/14	S	CAN	C	E	D1	L1	V	105
VW Polo inc. R-Line If desired for optical reasons, it is possible to get the complete bumper inc. cover at VW dealers. R-Line:extension for socket holder necessary, order no. 921740650001	06/09-04/14	KIT		321 748 900 113		120	18.5	7.0	50	1200		included in the KIT 321 527 300 113	-04/14	S	CAN	C	E	D1	L1	V	105
VW Polo inc. R-Line If desired for optical reasons, it is possible to get the complete bumper inc. cover at VW dealers. R-Line: extension for socket holder necessary, order no. 921740650001	06/09-07/17		 	321 832 600 001 321 878 600 001	 	120	14.5	7.0	50	1200	321 527 300 113	-04/14	S	CAN	C	E	D1	L1	V	105	
VW Polo inc. R-Line If desired for optical reasons, it is possible to get the complete bumper inc. cover at VW dealers. R-Line: extension for socket holder necessary, order no. 921740650001	04/14-07/17	KIT		321 832 900 113		120	16.5	7.0	50	1200	included in the KIT 321 529 300 113	04/14-07/17	S	CAN	C	E	D1	L1	V		
VW Polo inc. R-Line If desired for optical reasons, it is possible to get the complete bumper inc. cover at VW dealers. R-Line: extension for socket holder necessary, order no. 921740650001	04/14-07/17	KIT		321 878 900 113		120	18.5	7.0	50	1200	included in the KIT 321 529 300 113	04/14-07/17	S	CAN	C	E	D1	L1	V		
VW Polo Bluemotion Please check if there is a towing capacity in the car documents. extension for socket holder necessary, order no. 921740650001	06/09-04/14	KIT		321 741 900 113		120	17.0	7.0	50	1200	included in the KIT 321 527 300 113	-04/14	S	CAN	C	E	D1	L1	V	105	

















Volkswagen























Volkswagen

VW Polo Bluemotion Please order separately extension for socket holder, order no. 921740650001. Please check if there is a towing capacity in the car documents.	06/09-04/14	KIT		321 748 900 113		120	18.5	7.0	50	1200		included in the KIT 321 527 300 113	-04/14	S	CAN	C	E	D1	L1	V	105
VW Polo Bluemotion Please check if there is a towing capacity in the car documents.	06/09-07/17			321 832 600 001		120	14.5	7.0	50	1200		321 527 300 113 321 529 300 113	-04/14 04/14-07/17	S S	CAN CAN	C C	E E	D1 D1	L1 L1	V V	105
VW Polo Bluemotion Please order separately extension for socket holder, order no. 921740650001. Please check if there is a towing capacity in the car documents.	06/09-07/17			321 878 600 001		120	16.5	7.0	50	1200		321 527 300 113 321 529 300 113	-04/14 04/14-07/17	S S	CAN CAN	C C	E E	D1 D1	L1 L1	V V	105
VW Polo Bluemotion Please check if there is a towing capacity in the car documents. extension for socket holder necessary, order no. 921740650001	04/14-07/17	KIT		321 832 900 113		120	16.5	7.0	50	1200		included in the KIT 321 529 300 113	04/14-07/17	S	CAN	C	E	D1	L1	V	
VW Polo Bluemotion Please order separately extension for socket holder, order no. 921740650001. Please check if there is a towing capacity in the car documents.	04/14-07/17	KIT		321 878 900 113		120	18.5	7.0	50	1200		included in the KIT 321 529 300 113	04/14-07/17	S	CAN	C	E	D1	L1	V	
VW Polo Cross Please order cover for bumper cutout at VW dealers.	02/06-06/09			321 523 600 001		90	16.0	7.0	50	1200		321 524 300 113		S	C2	C	E	D1	L1	H	45
		KIT		321 523 900 113		90	18.0	7.0	50	1200		included in the KIT 321 524 300 113		S	C2	C	E	D1	L1	H	45
VW Polo Cross extension for socket holder necessary, order no. 921740650001	06/09-04/14	KIT		321 741 900 113		120	17.0	7.0	50	1200		included in the KIT 321 527 300 113	-04/14	S	CAN	C	E	D1	L1	V	105
VW Polo Cross Please order spoiler at VW dealers. extension for socket holder necessary, order no. 921740650001	06/09-04/14	KIT		321 748 900 113		120	18.5	7.0	50	1200		included in the KIT 321 527 300 113	-04/14	S	CAN	C	E	D1	L1	V	105
VW Polo Cross extension for socket holder necessary, order no. 921740650001	06/09-04/14			321 832 600 001		120	14.5	7.0	50	1200		321 527 300 113	-04/14	S	CAN	C	E	D1	L1	V	105













VW Polo Cross Please order spoiler at VW dealers. extension for socket holder necessary, order no. 921740650001	06/09-04/14			321 878 600 001		120	16.5	7.0	50	1200		321 527 300 113	-04/14	S	CAN	C	E	D1	L1	V	105
VW Polo Fun It is possible to receive a permission for the assembly of a towbar from VW.	04-09			321 523 600 001		90	16.0	7.0	50	1200		321 524 300 113		S	C2	C	E	D1	L1	H	45
		KIT		321 523 900 113		90	18.0	7.0	50	1200		included in the KIT 321 524 300 113		S	C2	C	E	D1	L1	H	45
VW Polo Gti extension for socket holder necessary, order no. 921740650001	06/09-04/14	KIT		321 741 900 113		120	17.0	7.0	50	1200		included in the KIT 321 527 300 113	-04/14	S	CAN	C	E	D1	L1	V	105
VW Polo Gti Please order cover for bumper cutout at VW dealers. extension for socket holder necessary, order no. 921740650001	06/09-04/14	KIT		321 748 900 113		120	18.5	7.0	50	1200		included in the KIT 321 527 300 113	-04/14	S	CAN	C	E	D1	L1	V	105
VW Polo Gti extension for socket holder necessary, order no. 921740650001	06/09-04/14			321 832 600 001		120	14.5	7.0	50	1200		321 527 300 113	-04/14	S	CAN	C	E	D1	L1	V	105
VW Polo Gti Please order cover for bumper cutout at VW dealers. extension for socket holder necessary, order no. 921740650001	06/09-04/14			321 878 600 001		120	16.5	7.0	50	1200		321 527 300 113	-04/14	S	CAN	C	E	D1	L1	V	105
VW Polo Hatchback for Polo Fun with permission for the assembly of a towbar by VW exc. GTi / 150 HP inc. facelift from 05/05, Blue Motion Please order the following parts for the bumper cover at VW dealer's: 1 spoiler 6Q6 807 433 B41 1 cover 6Q6 807 397 B41 2 bolt 6Q6 807	11/01-08/09			321 523 600 001		90	16.0	7.0	50	1200		321 523 300 113	-05/05	S	C2	C	E	D1	L1	H	45
												321 524 300 113	05/05-	S	C2	C	E	D1	L1	H	45













Volkswagen

VW Polo Hatchback for Polo Fun with permission for the assembly of a towbar by VW exc. GTI / 150 HP inc. facelift from 05/05, Blue Motion Please order the following parts for the bumper cover at VW dealer's: 1 spoiler 6Q6 807 433 B41 1 cover 6Q6 807 397 B41 2 bolt 6Q6 807	05/05-09	KIT		321 523 900 113		90	18.0	7.0	50	1200		included in the KIT 321 524 300 113	05/05-	S	C2	C	E	D1	L1	H	45
VW Polo VI (AW1) exc. GTI, exc. R-Line, exc. TGI exc. facelift	06/17-06/21			344 123 600 001		60	18.0	7.5	91	1270		344 110 300 113		S	CAN	C	E	D	L	V	60
		KIT		344 122 900 113		60	19.0	7.5	91	1270		included in the KIT 344 110 300 113		S	CAN	C	E	D	L	V	60
		KIT		344 123 900 113		60	20.0	7.5	91	1270		included in the KIT 344 110 300 113		S	CAN	C	E	D	L	V	60
VW Polo VI (AW1) exc. GTI, exc. R-Line, exc. TGI exc. facelift	06/17-06/21			344 122 600 001		60	17.0	7.5	91	1270		344 110 300 113		S	CAN	C	E	D	L	V	60
VW Polo VI AW1 for facelift exc. GTI exc. R-Line exc. TGI	06/21-			322 112 600 001		75	17.0	7.8	95	1200		344 110 300 113		S	CAN	C	E	D	L	V	60
				322 113 600 001		75	18.0	7.8	95	1200											
		KIT		322 112 900 113		75	19.0	7.8	95	1200		included in the KIT 344 110 300 113		S	CAN	C	E	D	L	V	60
		KIT		322 113 900 113		75	20.0	7.8	95	1200		included in the KIT 344 110 300 113		S	CAN	C	E	D	L	V	60
VW Sharan thermal-insulation plate inc. inc. 4WD bumper bracket is not necessary. 4-Motion: Please check the operating instructions of the vehicle before fitting the towbar.	05/00-08/10			321 665 600 001		90	24.0	12.5	100	2500		321 458 300 113		S	FRE	--	E	D1	L1	H	60
		KIT		321 665 900 113		90	26.0	12.5	100	2500		included in the KIT 321 458 300 113		S	FRE	--	E	D1	L1	H	60



















VW Sharan	09/10-03/22			321 698 600 001			22.0	12.3	100	2500		321 600 300 113	-03/22	S	FRE	C	E	D	L1	V	105		
		KIT		321 698 900 113			24.0	12.3	100	2500		included in the KIT 321 600 300 113	-03/22	S	FRE	C	E	D	L1	V	105		
VW Sharan Please order separately Spoiler and cover for bumper cutout at VW dealer's.	09/10-03/22			321 700 600 001			22.0	12.3	100	2500		321 600 300 113	-03/22	S	FRE	C	E	D	L1	V	105		
		KIT		321 700 900 113			24.0	12.3	100	2500		included in the KIT 321 600 300 113	-03/22	S	FRE	C	E	D	L1	V	105		
VW T-Cross (C11) exc. R-Line	12/18-			322 075 600 001		60	19.3	7.9	70	1400		344 110 300 113		S	CAN	C	E	D	L	V	60		
				322 076 600 001		60	20.6	7.9	70	1400					S	CAN	C	E	D	L	V	60	
		KIT		322 075 900 113		60	21.4	7.9	70	1400		included in the KIT 344 110 300 113		S	CAN	C	E	D	L	V	60		
		KIT		322 076 900 113		60	22.7	7.9	70	1400		included in the KIT 344 110 300 113		S	CAN	C	E	D	L	V	60		
VW T-Roc A11 Please order separately: holder for antenna amplifier 917131632001 for vehicles 17/07-12/21: extension for socket holder necessary, order no. 921740650001 inc. facelift 01/22-	07/17-			317 132 600 001		60	19.0	10.3	85	2000		305 407 300 113		with preliminary setup	S	CAN	C	E	D	L	H	30	
												305 408 300 107	→	without preliminary setup	S	CAN	C	E	--	--	V	60	
													305 408 300 113		without preliminary setup	S	CAN	C	E	D	L	V	60
													305 438 300 113		inc. WLC 2.0 without preliminary setup	S	CAN	C	E	D	L1	V	90
VW T-Roc A11 without preliminary setup Please order separately: holder for antenna amplifier 917131632001 for vehicles 17/07-12/21: extension for socket holder necessary, order no. 921740650001 inc. facelift 01/22-	07/17-	KIT		305 409 900 113		60	21.0	10.3	85	2000		included in the KIT 305 408 300 113		without preliminary setup	S	CAN	C	E	D	L	V	60	
		KIT		305 419 900 113		60	20.9	10.3	85	2000		included in the KIT 305 438 300 113		inc. WLC 2.0 without preliminary setup	S	CAN	C	E	D	L1	V	90	



















Volkswagen

VW T-Roc A11 Please order separately: holder for antenna amplifier 917131632001 inc. facelift 01/22-	07/17-		317 131 600 001		60	19.0	10.3	85	2000	305 407 300 113		with preliminary setup	S	CAN	C	E	D	L	H	30
										305 408 300 107	→	without preliminary setup	S	CAN	C	E	--	--	V	60
										305 408 300 113		without preliminary setup	S	CAN	C	E	D	L	V	60
										305 438 300 113		inc. WLC 2.0 without preliminary setup	S	CAN	C	E	D	L1	V	90
VW T-Roc A11 without preliminary setup Please order separately: holder for antenna amplifier 917131632001 inc. facelift 01/22-	07/17-	KIT 	305 408 900 113		60	19.0	10.3	85	2000	included in the KIT 305 408 300 113		without preliminary setup	S	CAN	C	E	D	L	V	60
										KIT 	305 418 900 113		60	20.9	10.3	85	2000	included in the KIT 305 438 300 113		inc. WLC 2.0 without preliminary setup
VW T-Roc A11 with preliminary setup Please order separately: holder for antenna amplifier 917131632001 inc. facelift 01/22-	07/17-	KIT 	317 154 900 113		60	20.5	10.3	85	2000	included in the KIT 305 407 300 113		with preliminary setup	S	CAN	C	E	D	L	H	30
VW T-Roc A11 with preliminary setup Please order separately: holder for antenna amplifier 917131632001 for vehicles 17/07-12/21: extension for socket holder necessary, order no. 921740650001 inc. facelift 01/22-	07/17-	KIT 	317 155 900 113		60	20.5	10.3	85	2000	included in the KIT 305 407 300 113		with preliminary setup	S	CAN	C	E	D	L	H	30
VW T-Roc Convertible Please order separately: holder for antenna amplifier 917131632001	12/19-		317 131 600 001		60	19.0	10.3	85	2000	305 407 300 113		with preliminary setup	S	CAN	C	E	D	L	H	30
										305 408 300 107	→	without preliminary setup	S	CAN	C	E	--	--	V	60
										305 408 300 113		without preliminary setup	S	CAN	C	E	D	L	V	60
										305 438 300 113		inc. WLC 2.0 without preliminary setup	S	CAN	C	E	D	L1	V	90

















VW T-Roc Convertible Please order separately: holder for antenna amplifier 917131632001 extension for socket holder necessary, order no. 921740650001	12/19-		317 132 600 001		60	19.0	10.3	85	2000		305 407 300 113	→	with preliminary setup	S	CAN	C	E	D	L	H	30
										305 408 300 107	without preliminary setup		S	CAN	C	E	--	--	V	60	
										305 408 300 113	without preliminary setup		S	CAN	C	E	D	L	V	60	
										305 438 300 113	inc. WLC 2.0 without preliminary setup		S	CAN	C	E	D	L1	V	90	
VW T-Roc Convertible without preliminary setup Please order separately: holder for antenna amplifier 917131632001	12/19-	KIT		305 408 900 113		60	19.0	10.3	85	2000		included in the KIT 305 408 300 113	without preliminary setup	S	CAN	C	E	D	L	V	60
											305 418 900 113		60	20.9	10.3	85	2000	included in the KIT 305 438 300 113	inc. WLC 2.0 without preliminary setup	S	CAN
VW T-Roc Convertible with preliminary setup Please order separately: holder for antenna amplifier 917131632001	12/19-	KIT		317 154 900 113		60	20.5	10.3	85	2000		included in the KIT 305 407 300 113	with preliminary setup	S	CAN	C	E	D	L	H	30
VW T-Roc Convertible without preliminary setup Please order separately: holder for antenna amplifier 917131632001 extension for socket holder necessary, order no. 921740650001	12/19-	KIT		305 409 900 113		60	21.0	10.3	85	2000		included in the KIT 305 408 300 113	without preliminary setup	S	CAN	C	E	D	L	V	60
											305 419 900 113		60	20.9	10.3	85	2000	included in the KIT 305 438 300 113	inc. WLC 2.0 without preliminary setup	S	CAN
VW T-Roc Convertible with preliminary setup Please order separately: holder for antenna amplifier 917131632001 extension for socket holder necessary, order no. 921740650001	12/19-	KIT		317 155 900 113		60	20.5	10.3	85	2000		included in the KIT 305 407 300 113	with preliminary setup	S	CAN	C	E	D	L	H	30









Volkswagen

VW T7 Multivan STM, STN inc. Plugin-Hybrid	08/21-			322 100 600 001			90	18.7	11.5	140	2000		322 100 300 113	08/21- inc. Plugin-Hybrid	S	CAN	C	E	D1	L1	V	90
				322 101 600 001			90	18.7	11.5	140	2000											
		KIT		322 100 900 113			90	20.7	11.5	140	2000		included in the KIT 322 100 300 113	08/21- inc. Plugin-Hybrid	S	CAN	C	E	D1	L1	V	90
				322 101 900 113			90	20.7	11.5	140	2000		included in the KIT 322 100 300 113	08/21- inc. Plugin-Hybrid	S	CAN	C	E	D1	L1	V	90
VW Taigo CS1 inc. R-Line	09/21-			322 111 600 001			90	20.0	7.5	90	1200		344 110 300 113	09/21-	S	CAN	C	E	D	L	V	60
			KIT		322 111 900 113		90	22.1	7.5	90	1200		included in the KIT 344 110 300 113	09/21-	S	CAN	C	E	D	L	V	60
VW Tiguan	11/07-03/16			305 421 600 001		90	19.0	12.0	100	2500		321 600 300 113			S	FRE	C	E	D	L1	V	105
				305 423 600 001		90	21.0	12.0	140	2500												
		KIT		321 727 900 113		90	21.0	12.0	100	2500		included in the KIT 321 600 300 113		S	FRE	C	E	D	L1	V	105	
				321 728 900 113		90	23.0	12.0	100	2500		included in the KIT 321 600 300 113		S	FRE	C	E	D	L1	V	105	
VW Tiguan II (AD1) Please order separately: holder for antenna amplifier 917131632001	04/16-08/23			321 906 600 001		60	16.0	12.6	100	2500		305 407 300 113	with preliminary setup	S	CAN	C	E	D	L	H	30	
				321 907 600 001		60	17.8	12.6	100	2500		305 408 300 107	→ without preliminary setup	S	CAN	C	E	--	--	V	60	
												305 408 300 113	04/16-08/23 without preliminary setup	S	CAN	C	E	D	L	V	60	
												305 438 300 113	04/16-08/23 inc. WLC 2.0 without preliminary setup	S	CAN	C	E	D	L1	V	90	



VW Tiguan II (AD1) without preliminary setup Please order separately: holder for antenna amplifier 917131632001	04/16-08/23	KIT		321 906 900 113		60	17.3	12.6	100	2500		included in the KIT 305 408 300 113		04/16-08/23 without preliminary setup	S	CAN	C	E	D	L	V	60
		KIT		321 911 900 113		60	20.3	12.6	2500	2500		included in the KIT 305 438 300 113		04/16-08/23 inc. WLC 2.0 without preliminary setup	S	CAN	C	E	D	L1	V	90
		KIT		321 907 900 113		60	19.1	12.6	100	2500		included in the KIT 305 408 300 113		04/16-08/23 without preliminary setup	S	CAN	C	E	D	L	V	60
		KIT		321 910 900 113		60	19.7	12.6	100	2500		included in the KIT 305 438 300 113		04/16-08/23 inc. WLC 2.0 without preliminary setup	S	CAN	C	E	D	L1	V	90
VW Tiguan II (AD1) without preliminary setup	04/16-08/23	KIT		322 096 900 113		90	31.5	12.4	150	2500		included in the KIT 322 096 300 153		not available individually	S							
VW Touareg exc. vehicles with spare wheel on tailgate To guarantee an optimal appearance of the vehicle it is necessary to order the rear lower spoiler and the cover (depending on the equipment of the vehicle) separately from the VW dealer (see or	11/02-04/10	KIT		321 500 900 113	→ 	150	36.0	16.4	140	3500		included in the KIT 321 500 300 113	→	-04/10	S	CAN	--	E	D	L1	H	45
VW Touareg exc. vehicles with spare wheel on tailgate To guarantee an optimal appearance of the vehicle it is necessary to order the rear lower spoiler and the cover (depending on the equipment of the vehicle) separately from the VW dealer (see or	11/02-10/17			321 735 600 001		150	33.5	16.4	140	3500		321 500 300 113	→	-04/10	S	CAN	--	E	D	L1	H	45
				321 736 600 001		150	34.0	16.4	140	3500		321 765 300 113		04/10-08/14 not for vehicles with ACC / distance regulation	S	CAN	C	E	D	L1	V	180
												321 766 300 113		08/14-10/17	S	CAN	C	E	D	L	H	
VW Touareg exc. vehicles with spare wheel on tailgate To guarantee an optimal appearance of the vehicle it is necessary to order the rear lower spoiler and the cover (depending on the equipment of the vehicle) separately from the VW dealer (see or	04/10-08/14	KIT		321 736 900 113		150	36.0	16.4	140	3500		included in the KIT 321 765 300 113		04/10-08/14 not for vehicles with ACC / distance regulation	S	CAN	C	E	D	L1	V	180

Volkswagen





VW Touareg exc. vehicles with spare wheel on tailgate To guarantee an optimal appearance of the vehicle it is necessary to order the rear lower spoiler and the cover (depending on the equipment of the vehicle) separately from the VW dealer (see or	08/14-10/17	KIT		321 766 900 113			36.0	16.4	140	3500				included in the KIT 321 766 300 113		08/14-10/17	S	CAN	C	E	D	L	H		
VW Touareg CR7	11/17-			322 064 600 001		60	27.0	15.7	191	3500			305 417 300 113 305 437 300 113 305 447 300 113	→			S	A	C1	E2	D	L1	H	60	
																	S	CAN	C	E	D	L	H	60	
																	S	CAN	C	E	D	L1	H	60	
VW Touareg	11/17-	KIT		322 064 900 113		60	28.0	15.7	191	3500			included in the KIT 305 437 300 113				S	CAN	C	E	D	L	H	60	
VW Touran inc. Cross-Touran	03/03-09/15			321 536 600 001		90	19.5	9.9	75	1800			321 600 300 113				S	FRE	C	E	D	L1	V	105	
		KIT		321 536 900 113		90	21.5	9.9	75	1800			included in the KIT 321 600 300 113				S	FRE	C	E	D	L1	V	105	
VW Touran inc. Cross-Touran 08/10-: Please order separately cover for bumper cutout at VW dealer's.	03/03-09/15			321 838 600 001		90	20.0	9.9	75	1800			321 600 300 113				S	FRE	C	E	D	L1	V	105	
		KIT		321 838 900 113		90	22.0	9.9	75	1800			included in the KIT 321 600 300 113				S	FRE	C	E	D	L1	V	105	
VW Touran	09/15-			321 814 600 001		60	15.5	10.8	80	2100			305 407 300 113		with preliminary setup		S	CAN	C	E	D	L	H	30	
				321 815 600 001		60	16.0	10.8	80	2100			305 408 300 107	→	without preliminary setup		S	CAN	C	E	--	--	V	60	
													305 408 300 113		without preliminary setup		S	CAN	C	E	D	L	V	60	
													305 438 300 113		inc. WLC 2.0 without preliminary setup		S	CAN	C	E	D	L1	V	90	

VW Touran without preliminary setup	09/15-	KIT		321 814 900 113			60	19.5	10.8	80	2100		included in the KIT 305 408 300 113	without preliminary setup	S	CAN	C	E	D	L	V	60
		KIT		321 819 900 113			60	17.4	10.8	80	2100		included in the KIT 305 438 300 113	inc. WLC 2.0 without preliminary setup	S	CAN	C	E	D	L1	V	90
		KIT		321 815 900 113			60	20.0	10.8	80	2100		included in the KIT 305 408 300 113	without preliminary setup	S	CAN	C	E	D	L	V	60
		KIT		321 818 900 113			60	17.9	10.8	80	2100		included in the KIT 305 438 300 113	inc. WLC 2.0 without preliminary setup	S	CAN	C	E	D	L1	V	90
VW Transporter T4 Van inc. Syncro and Caravelle	01/96-07/03			321 391 600 001			90	20.2	13.4	105	2600		321 318 300 113	09/98-	S	C2	--	--	D1	--		45
VW Transporter T4 Van inc. Syncro and Caravelle bracket for towball: 921405631005	01/96-07/03			321 405 600 001			90	21.0	13.4	100	2600		321 318 300 113	09/98-	S	C2	--	--	D1	--		45
VW Transporter T4 Van inc. Syncro and Caravelle	09/98-07/03	KIT		321 391 900 113			90	22.2	13.4	105	2600		included in the KIT 321 318 300 113	09/98-	S	C2	--	--	D1	--		45

Volkswagen

<p>VW Transporter T5 Van without preliminary setup inc. 4 Motion, exc. Rockton To guarantee an optimal fit of the bumper it is necessary to mount 2 foam carriers, please order from VW-dealer, order no. 7H0 807 252 A Van (without back side windows) 10/09-: To guarantee an optimal fit of the bumper it is ne</p>	10/09-08/15	KIT		321 650 900 113			115	22.5	14.0	100	2500	included in the KIT 321 454 300 113	10/09-08/15 without preliminary setup	S	CAN	C	E	D	L1	V	180	
													300 028 300 113	charging cable (extension kit) (Please order additionally.)								45
													321 025 300 113	additional cable for continuous plus (Please order additionally.)	--	--	--	E1	D	L	V	
													321 455 300 001	10/09-extension kit for vehicles without fuse box under the drivers seat (Please order additionally.)	S						V	60
<p>VW Transporter T5 Van without preliminary setup inc. 4 Motion To guarantee an optimal fit of the bumper it is necessary to mount 2 foam carriers, please order from VW-dealer, order no. 7H0 807 252 A Van (without back side windows) 10/09-: To guarantee an optimal fit of the bumper it is necessary to mou</p>	10/09-08/15	KIT		321 651 900 113			120	23.5	14.0	100	2500	included in the KIT 321 454 300 113	10/09-08/15 without preliminary setup	S	CAN	C	E	D	L1	V	180	
													321 455 300 001	10/09-extension kit for vehicles without fuse box under the drivers seat (Please order additionally.)	S						V	60
													321 025 300 113	additional cable for continuous plus (Please order additionally.)	--	--	--	E1	D	L	V	
													300 028 300 113	charging cable (extension kit) (Please order additionally.)								45



























Volkswagen

VW Transporter T6 Van without preliminary setup	06/15-09/19	KIT		321 650 900 113			115	22.5	14.0	100	2500		included in the KIT 321 454 300 113	06/15-09/19 without preliminary setup	S	CAN	C	E	D	L1	V	180	
		KIT		321 651 900 113			120	23.5	14.0	100	2500		321 451 300 100	additional wire trailer stability systemIt is possible to activate trailer stability system starting from the following chassis numbers:WV2ZZZ7H and WV2ZZZ7HZ5H0597 (Please order additionally.)	S	--	--	E1	--	--	V	60	
														321 455 300 001	extension kit for vehicles without fuse box under the driver's seat (Please order additionally.)	S						V	60
														300 028 300 113	charging cable (extension kit) (Please order additionally.)								45
													321 025 300 113	additional cable for continuous plus(Please order additionally.)	--	--	--	E1	D	L	V		
VW Transporter T6 Van without preliminary setup	10/19-	KIT		322 073 900 113			115	19.7	14.0	100	2500		included in the KIT 322 074 300 113	10/19- without preliminary setup	S	CAN	C	E	D	L	V	120	
		KIT		322 074 900 113			120	21.7	14.0	100	2500		included in the KIT 322 074 300 113	10/19- without preliminary setup	S	CAN	C	E	D	L	V	120	

Volvo

Volvo S40 / V50 exc. Sports, exc. R design	02/04-12/12		320 059 600 001		40	9.7	8.9	100	1600		300 210 300 113	06/07- 06/07-	--	A	--	E1	D1	L1	V	90
											320 240 300 107		S	CAN	--	E2	--	--	H	60
													320 240 300 113	S	CAN	--	E2	D	L1	H
Volvo S40 / V50 exc. Sports, exc. R design	06/07-12/12	KIT 	320 059 900 113		40	11.7	8.9	100	1600		included in the KIT 320 240 300 113	06/07-	S	CAN	--	E2	D	L1	H	60
Volvo S60	06/10-01/18		320 071 600 001		90	15.0	10.2	80	1800		300 320 300 183	additional cable for 2nd fog light								
				320 072 600 001		90	17.0	10.2	80	1800			320 543 300 113	-01/18	S	CAN	--	E2	D1	L1
		KIT 	320 071 900 113		90	17.0	10.2	80	1800		included in the KIT 320 543 300 113	-01/18	S	CAN	--	E2	D1	L1	H	45
		KIT 	320 072 900 113		90	19.0	10.2	80	1800		included in the KIT 320 543 300 113	-01/18	S	CAN	--	E2	D1	L1	H	45
Volvo S60 III (224)	02/19-		320 173 600 001		60	24.1	12.6	150	2000											
				320 174 600 001		60	27.0	12.6	150	2000										
Volvo S60/V60 Cross Country (224)	07/15-08/18		320 111 600 001		90	19.0	10.5	90	1900		300 320 300 183	additional cable for 2nd fog light								
				320 112 600 001		90	20.5	10.5	90	1900			320 543 300 113	S	CAN	--	E2	D1	L1	H
		KIT 	320 111 900 113		90	20.8	10.5	90	1900		included in the KIT 320 543 300 113		S	CAN	--	E2	D1	L1	H	45
		KIT 	320 112 900 113		90	22.3	10.5	90	1900		included in the KIT 320 543 300 113		S	CAN	--	E2	D1	L1	H	45

Volvo

Volvo V60 II 225	02/18-			320 173 600 001		60	24.1	12.6	150	2000		320 173 300 107			S	A	C1	E2	--	--	H	75
				320 174 600 001		60	27.0	12.6	150	2000		320 173 300 113			S	A	C1	E2	D	L1	H	75
		KIT		320 173 900 113		60	28.9	10.7	110	2100		included in the KIT 320 173 300 113			S	A	C1	E2	D	L1	H	75
		KIT		320 174 900 113		60	25.7	12.6	150	2000		included in the KIT 320 173 300 113			S	A	C1	E2	D	L1	H	75
Volvo V60 II Cross Country 227	09/18-			320 181 600 001		60	24.2	12.6	150	2000		320 173 300 107			S	A	C1	E2	--	--	H	75
				320 182 600 001		60	27.0	12.6	150	2000		320 173 300 113			S	A	C1	E2	D	L1	H	75
		KIT		320 181 900 113		60	25.7	12.6	150	2000		included in the KIT 320 173 300 113			S	A	C1	E2	D	L1	H	75
		KIT		320 182 900 113		60	28.6	12.6	150	2000		included in the KIT 320 173 300 113			S	A	C1	E2	D	L1	H	75
Volvo V70 inc. AWD exc. XC70	03/00-09/07			320 090 600 001		100	21.0	10.3	80	2000		300 078 300 113	03/00-09/07	--	FRE	--	--	D1	L1	V		
Volvo V70 without height control inc. AWD	09/07-04/16			320 069 600 001		90	20.0	11.0	85	2100		300 320 300 183	additional cable for 2nd fog light									
				320 075 600 001		60	22.0	11.0	85	2100		320 543 300 113		S	CAN	--	E2	D1	L1	H	45	
		KIT		320 069 900 113		90	22.0	11.0	85	2100		included in the KIT 320 543 300 113		S	CAN	--	E2	D1	L1	H	45	
		KIT		320 075 900 113		60	24.0	11.0	85	2100		included in the KIT 320 543 300 113		S	CAN	--	E2	D1	L1	H	45	

Towing brackets, couplings and special towbars

Universal HGV towing brackets





Please pay attention to the D-value of each component!

Towing bracket
with integral anderrun guard
order no. 313404600001
and towball
order no. 329103600001



under run guard
approval no.: e13-6131

Towball is not included.





	order no.	 kg	D-value kN	 kg	 kg		
Towing bracket with integral anderrun guard for HGV. Swap system permitted.	313404600001	69,0	25,1	150	3000 3500	17000 9400	
towball recommended	329103600001	8,2	25,1	120	3000 3500	17000 9400	

Towing bracket
with integral anderrun guard
order no. 342179600001
and towball
order no. 329103600001



under run guard
approval no.: e13-6130

Towball is not included.

	order no.	 kg	D-value kN	 kg	 kg		
Towing bracket with integral anderrun guard for HGV. Swap system permitted.	342179600001	76,0	23,5	150	3500	z.B. 7500	
towball recommended	329103600001	8,2	25,1	120			

Universal HGV- electrical kits for 12V	order no.	car specific	flash control	coding	PDCcut off	perma- nent plus	charging line	electrical connec- tion	moun- ting time	
	300201300113		A			D1	L1	V		

Technical data for universal HGV towbars

all measurements in mm

Towing brackets universally applicable due to 2-dimensional adjustment (height and width)

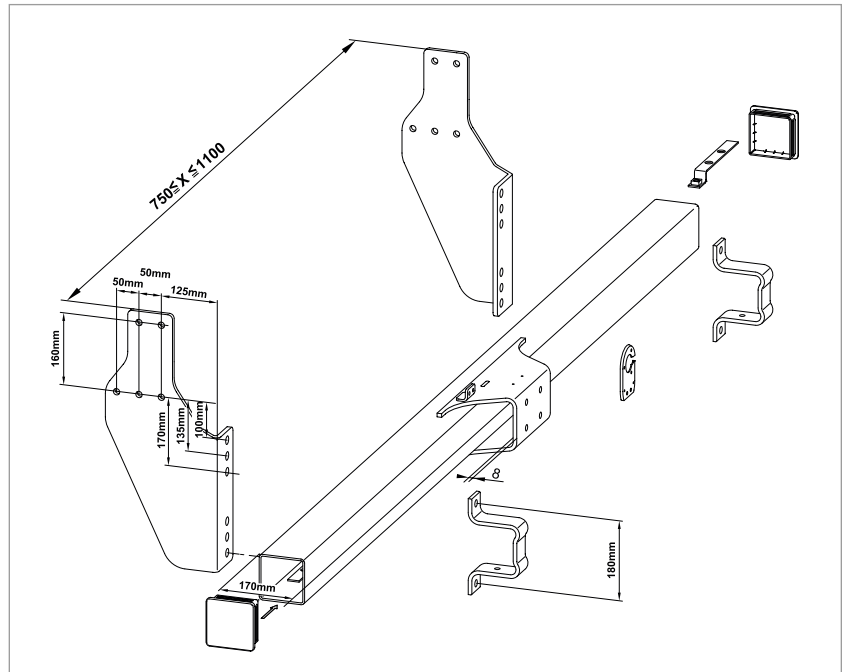





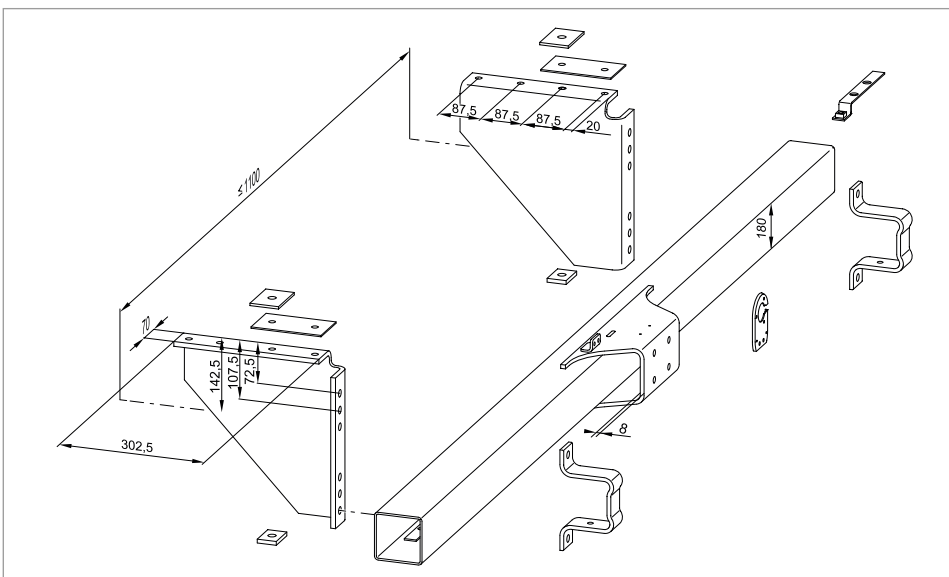

313 404

342 179

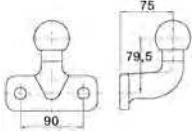
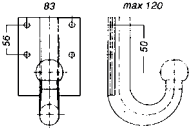
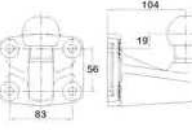
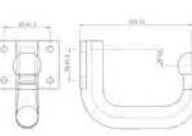
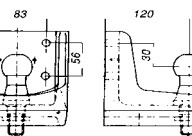
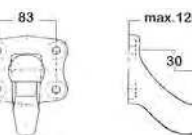
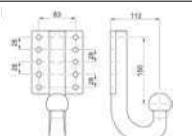
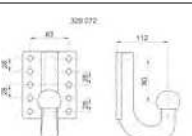
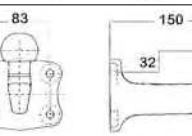

Towballs and Couplings for HGV and Off-Road Vehicles

	order no.		D-Value kN			kg 
	329076600001	2,4	20,55	350	2.500 or 2.200 or 2.000	12.924 or 8.317 or 5.217
	incl. 2 screws M 16 x 50, 8.8					
	329042600001 discontinued model	4,4	17,2	100	2.800 or 2.500 or 2.000	4.700 or 5.800 or 14.200
	329141600001	4,0	24,8	250	3.500 or 3.815 or 3.385	9.115 or 7.500 or 10.000
	329143600001	4,5	17,5	200	4.900 or 6.200 or 3.600	2.800 or 2.500 or 3.500
	329103600001	8,5	25,1	150	3.500 or 2.500 or 3.000	9.400 or 40.000 or 17.000
	329062600001	3,6	23,5	150	2.800 or 3.100 or 3.500	15.000 or 10.000 or 7.500
	329160600001 For vehicles without a brake cable eyelet the brake cable holder 329071631001 is required.	4,1	17,5	150	2.500 oder 2.800 oder 3.500	6.200 oder 4.900 oder 3.600
	329072600001	3,7	17,5	150	2.500 or 2.800 or 3.500	6.200 or 4.900 or 3.600
	329089600001	2,8	17,5	150	2.800 or 2.500 or 3.500	4.900 or 6.200 or 3.600
	329113600001	1,0	17,7	140	2.800 oder 2.500 oder 2.000	4.700 oder 5.800 oder 14.000

Mounting parts for Couplings



traverse of the towing vehicle or towing bracket	towball or coupling (order no. ends with ...600001)	screw kit*
8 - 12 mm	329 042 329 059, 329 062, 329 071, 329 072 329 060, 329 089, 329 103	900 040 632 340 900 045 632 325 900 055 632 552
15 - 20 mm	329 042, 329 057, 329 062, 329 071, 329 072 329 059 329 060, 329 103	900 050 632 424 900 055 632 552 900 060 632 523
60 - 65 mm	329 042, 329 062, 329 071, 329 072 329 059 329 060, 329 103, 329 089	900 095 632 553 900 100 632 527 900 105 632 554
65 - 70 mm	329 042, 329 062, 329 071, 329 072 329 059 329 060, 329 103, 329 089	900 100 632 527 900 105 632 554 900 110 632 505
70 - 75 mm	329 042, 329 062, 329 071, 329 072 329 059 329 060, 329 103, 329 089	900 105 632 554 900 110 632 505 900 115 632 524
75 - 80 mm	329 042, 329 062, 329 071, 329 072 329 059 329 060, 329 103, 329 089	900 110 632 505 900 115 632 524 900 120 632 516
80 - 85 mm	329 042, 329 062, 329 071, 329 072 329 059 329 060, 329 103, 329 089	900 115 632 524 900 120 632 516 900 125 632 504
85 - 90 mm	329 042, 329 062, 329 071, 329 072 329 059 329 060, 329 103, 329 089	900 120 632 516 900 125 632 504 900 130 632 539
90 - 95 mm	329 042, 329 062, 329 071, 329 072 329 059 329 060, 329 103, 329 089	900 125 632 504 900 130 632 539 900 135 632 379

* Each kit contains: 4 screws M10 10.9, 4 nuts, 8 washers.
4th - 6th position of the part no. indicates the length of the screws in mm.

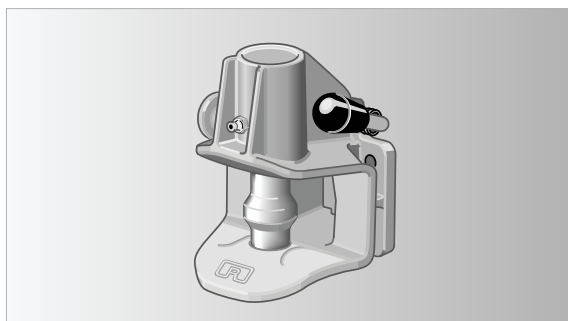
Coupling bolt



Coupling bolt
Rockinger-Nr. 243A11000

order no.	screw-hole circle mm	D-Value kN	Dc-Value kN (depends on the height of the ball)		
342090600001	83 x 56	18,0	min. 18,0 max. 30,0	5,0	250

Swap system

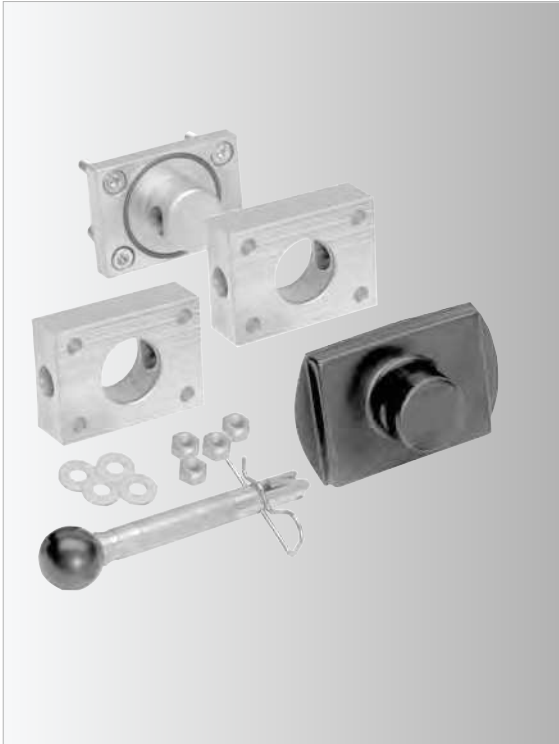

order no.	set	screw-hole circle mm	D/Dc-Value kN		
329064600001	1 base plate 2 exchangeable plates 1 cover	83 x 56	18,5	3,5	120

Application in association with:

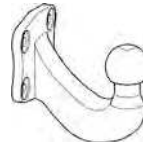

towball

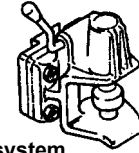

coupling system

*screws / mounting parts (depending on towing brackets and couplings) regard below.

Spare parts for swap system 329064600001

order no.	Bezeichnung
929 064 605 002	base plate
900 001 508 003	O ring
929 064 605 101	exchangeable plate
929 064 630 101	cover
929 064 625 001	bolt

Mounting parts for swap system

screw kit*	Towball or coupling on adapting plate	flange	screws
900 050 636 186	329 042	5 - 10 mm	M 10x50
900 055 636 187	329 059, 329 062, 329 072, 329 089 Rockinger bolt coupling	10 - 15 mm	M 10x55
900 060 636 188	329 060, 329 103	15 - 20 mm	M 10x60

screw kit*	base plate on towing vehicle or towbar	screws
900 040 636 176	8 - 12 mm	M 10x40
900 100 636 180	70 - 75 mm	M 10x100
900 110 636 182	80 - 85 mm	M 10x110
900 130 636 185	95 - 105 mm	M 10x130

* Each kit contains

4 screws M10 (10.9)
4 nuts M10
4 washers 10,5

4th - 6th position of the part no. indicates the length of the screws in mm.

Swap system

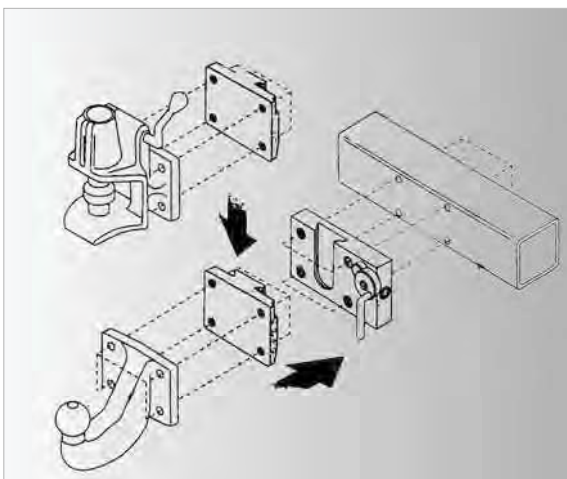

order no.	set	screw-hole circle mm	D/Dc-Value kN		
342032600001	1 ground plate 2 exchangeable plates	83x56	30	5,8	120

Application in association with:



towball

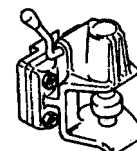

coupling system

*screws / mounting parts (depending on towing brackets and couplings) regard below.

Towbars

Accessories

Spare parts

Accessories



Towball cover (10 pcs.)

package 100 pieces: order no. 917 034 630 100
package 800 pieces: order no. 9170 34 630 101

order no.: 917 034 630 010



Towball cover blue "Baseball cap" (10 pcs.)

package 50 pieces: order no. 300 050 001 909

order no.: 300 010 001 909



Snap gauge

order no.: 900 001 535 051

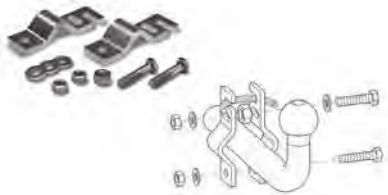

Bracket

for the safety breakaway rope of the trailer

order no.: 935 211 627 001



Bracket 50 mm Ø

for the safety breakaway rope of the trailer

order no.: 921 540 627 001



Bracket 56 mm Ø

for the safety breakaway rope of the trailer

order no.: 905 243 627 001



Bracket 84 mm Ø

for the safety breakaway rope of the trailer

order no.: 905 276 627 001

Accessories



Presentation rack for towbars

(towbars are not included)

order no.: 300 100 600 001

Steps



Step

for Mercedes-Benz Sprinter II and VW LT Crafter 03/06-
(van and minibus)
Only in conjunction with towbars WAM no.:
313 267/272/273/376 600001

order no.: 313 285 600 001



Step universal

for all universal HGV towbars with 4 hole towballs and
universal HGV towbars with 2 hole towballs with a hole
spacing of 90 mm
e.g. Citroen Jumper, Fiat Ducato, Mercedes Sprinter,
Peugeot Boxer, VW Crafter

order no.: 313 440 600 001

Side caps for towing brackets



Side cap (2 pcs.) (measurements: 100x100 mm)

342035, 332110, 342076/313146/313192/313193,
313404/342179

order no.: 900 001 503 587

Spare parts for detachable towbars



Key for lock automatic towball

(package 2 pcs.)

*The last two digits are the numbers that appear on the key head or that you have noted in your manual. Declaration and procedure for ordering keys please find on our website www.westfalia-automotive.com.

order no.: 942 001 513 2xx



Master key set for detachable towbars

order no.: 942 001 513 999



Cover for lock automatic towball

(package 2 pieces)

(package 10 pieces = order no. 905 112 630 101)

order no.: 905 111 630 101



Cover for lock automatic towball

with protection against loss

(package 2 pieces)

(package 10 pieces = 621 534 630 102)

order no.: 921 534 630 101



Skai leather zip bag (for all detachable towbars)

order no.: 900 001 504 923



Metal nut

(incl. 4 steel balls, 1 circlip)

of the ball up to 40 mm

order no.: 914 234 622 101

Order no. towbar	Type	Spare part towball	Plug	Accessory bag	Socket holder	Mounting tube & other fastening parts	Holder for socket holders & other fastening parts
303078600001	303 078 A	903078601001	903078630121	903078650001	-	-	903078611003
303091600001	303 090	no longer available	921630630121	--	--	--	--
303095600001	303 094 B	935268601001	913183630121	903095650001	-	-	-
303113600001	303 084 B	903085601001	903078630121	903085650001	-	903057619001	903081616102
303123600001	303 121	903078601001	903078630121	903121650001	-	-	-
303124600001	303 121	903078601001	903078630121	903121650001	-	-	-
303127600001	303 127	935268601001	903078630121	-	903127650001	-	903127619001
303130600001	303 078 A	no longer available	903078630121	903130650001	-	903078611001	-
303140600001	303 140	906230601003	903140630103	903140650002	-	-	903140619001
303144600001	303 127	935268601001	903078630121	-	903127650001	-	903144619001
303149600001	303 149	903078601001	903078630121	903149650001	-	-	-
303150600001	303 149	903078601001	903078630121	903149650001	-	-	-
303155600001	303 155	906230601003	903078630121	903140650002	-	-	903140619001
303173600001	303 149	903078601001	903078630121	903149650001	-	-	-
303176600001	303 176	903078601001	903078630121	903149650001	-	-	-
303178600001	303 176	903078601001	903078630121				
303185600001	303 174	903174600011	903140630103				
303189600001	303 189	903189601090	903078630121	-	-	-	-
303202600001	303 186	903186600003	903140630103	903202650001	921504608001	-	-
303205600001	303 205	915055601001	903078630121	903205650001	-	-	-
303207600001	303 137	903170601006	903137630101	903207650001	-	-	-
303212600001	303 212	-	-	903212650001	-	-	-
303228600001	303 134 (A)	935268601001	913183630121	903228650001	-	-	903228619001
303229600001	303 134 (A)	935268601001	913183630121	903228650001	-	-	903229691001
303230600001	303 140A	903230601005	903078630121	903230650002	921504608001	-	903140619001
303231600001	303 174 (A)	903231601005	903078630121	903230650002	-	-	903174619001
303232600001	303 155A	903230601005	903078630121	903230650002	921504608001	-	903140619001
303235600001	303 186	903186601003	903140630103				
303237600001	303 186	903186601003	921630630121				
303240600001	303 240	914251601090	913183630121	903240650001	921504608001	-	-
303241600001	303 241	-	-	903241650001	-	-	-
303253600001	303 186	903186601003	921630630121				
303266600001	303 264	914251601090	913183630121	903266650001	921504608001	-	-
303267600001	303 265	-	-	903267650001	-	-	-
303273600001	303 265	903273601009	921630630121	903273650001	921504608001	-	-
303290600001	303 290	903290601009	903137630101	903290650001	-	-	-
303294600001	303 294	903292601019	921630630121	903294650001	921504608001	-	-
303309600001	303 309	-	-	903273650001	-	-	-
303298600001	303 205	915055601001	903078630121				
303299600001	303 140 (A)	903230601005	921630630121				
303300600001	303 155 (A)	903230601005	921630630121				
303301600001	303 186	903186601003	921630630121	303202650001	921504608001	-	-
303302600001	303 186	903186601003	921630630121	303202650001	921504608001	-	-
303303600001	303 240	914251601090	913183630121	303240650001	921504608001	-	-
303304600001	303 189	903189601090	903078630121	-	-	-	-
303313600001	303 313	-	-	903313650001	-	-	-
303314600001	303 314	907336601090	921630630121	903313650001	921504608001	-	-
303317600001	303 317	903315601006	913183630121	903317650001	907292608001	-	-
303323600001	303 323	915055601001	903078630121	903205650001	-	-	-
303328600001	303 294	903292601019	921630630121				
303330600001	303 240	914251601090	913183630121	903240650001	921504608001	-	-
303332600001	303 240	914251601090	913183630121				
303333600001	303 304	903189601090	921630630121				
303336600001	303 336	903292601019	921630630121	903336650001	921504608001	-	-
303337600001	303 337	-	-	903337650001	-	-	-
303338600001	303 342	916128601090	903078630121	903337650001	921504608002	-	-
303339600001	303 339	-	-	903339650001	-	-	-
303340600001	303 340	921546601090	921630630121	903339650001	921504608002	-	-
303351600001	303 351	-	-	903351650001	-	-	-
303352600001	303 352	907305601090	903078630121	903351650001	932541608002	-	303352613001
303355600001	303 355	-	-	903372650001	-	-	-
303366600001	303 366	907305601090	921630630121	903351650001	932541608002	-	303352613001
303368600001	303 273	903273601009	921630630121	903273650001	921504608001	-	-
303370600001	303 370	903292601019	921630630121	903336650001	921504608001	-	-
303372600001	303 372	903315601006	903078630121	903372650001	921504608001	-	-
303393600001	303 313	-	-	903393650001	-	-	-
303394600001	303 314	907336601090	921630630121	903393650001	921504608001	-	-
303398600001	303 398	916128601090	913183630121	903397650001	921504608002	-	-
303404600001	303 340	905405601001	921630630121	903339650001	921504608001	-	-
303412600001	BM46AU	913082601090	913183630121	903413650001	921504608001	933096621001	933096631001
303431600001	BM38U	917034601090	921630630121		921504608001	933096621001	933096631001
303433600001	BM44U	916128601090	913183630121	-	921504608001	933096621001	933096631001
303441600001	BM37U	917034601090	921630630121	-	-	-	-
303476600001	BM48U	914294601090	913183630121		921504608001	933096621001	933096631001
303478600001	BM47U	913082601090	913183630121		921504608001	933096621001	933096631001
303483600001	BM49U	907200601005	921630630121	903495650001	921504608001	933096621001	933096631001
303485600001	BM50U	920057601090	913183630121		921504608001	933096621001	933096631001
303487600001	BM51U	913082601090	913183630121		921504608001	933096621001	933096631001
303496600001	BM47AU	913082601090	913183630121	903495650001	921504608001	933096621001	933096631001
303498600001	BM53U	916128601090	913183630121	903498650001	921504608001	933096621001	933096631001

Order no. towbar	Type	Spare part towball	Plug	Accessory bag	Socket holder	Mounting tube & other fastening parts	Holder for socket holders & other fastening parts
303500600001	BM51AU	913082601090	913183630121	903499650001	921504608001	933096621001	933096631001
303513600001	BM1247	932098601090	913183630121		907292608001	-	-
303514600001	---	914251601090	913183630121		907292608001	-	-
303517600001	BM878U	913082601090	913183630121	903516650001	907292608001	933096621001	933096631001
304056600001	304 056	no longer available	921630630121	904056650001		904056617001	-
304057600001	304 057	904057601001	921630630121	904057650001	-	-	-
304059600001	304 048	no longer available	903011630108	904047650001	-	904047619001	-
304060600001	304 060 (A)	no longer available	903011630108	904060650001	-	904060606001	-
304068600001	304 068	906187601090	913183630121	904068650001	-	-	-
304072600001	304 072	914266601001	913183630121	904072650001	921504608001	-	-
304073600001	304 073	921505601005	913183630121	904073650001	921504608001	-	-
304079600001	304 078	916114601001	913183630121	904079650001	-	-	-
304092600001	SI 080	914294601090	921630630121	-	-	-	-
304100600001	304 100	914294601090	913183630121	904099650001	921504608001	-	-
304128600001	SI 107	904120601001	-	-	-	-	-
304131600001	SI 088	914294601090	921630630121	-	-	-	-
304135600001	SI 097	914251601090	913183630121	-	-	-	-
304137600001	SI 100	904119601001	-	-	-	-	-
304139600001	SI 072	921556601005	921630630121	-	-	-	-
304144600001	SI 150	915144601090	921630630121	-	-	-	-
304145600001	01.4606	916165601090	913183630121	-	-	933051621090	-
304148600001	SI 150	915144601090	921630630121	-	-	-	-
304149600001	SI 206	915144601090	921630630121	-	-	-	-
304152600001	SI 220	915144601090	921630630121	-	-	-	-
304160600001	SI 222	921556601005	921630630121	-	-	-	-
304190600001	TY184	329076600001	-	904190650001	-	-	-
304209600001	SI 255	904189601001	933034630101	-	-	-	-
304212600001	SI 255	904189601001	933034630101	-	-	-	-
304213600001	C642U	914251601090	913183630121	904213650001	921504608001	933096621001	933096631001
304216600001	SI 260	914294601090	921630630121	-	921504608001	-	-
305115600001	305 073	905071601003	921630630121	-	-	-	-
305119600001	305 073 A	905071601003	921630630121	905119650001	-	-	-
305131600001	305 117	905117601001	905051630106	905117650001	-	905117605003	905117616001
305132600001	305 117	905117601001	921630630121	905117650001	-	905117605003	905117616001
305154600001	305 073 H	905071601003	921630630121	905119650001	-	-	-
305156600001	305 112 A	905112601001	905063630103	905122650001	-	905112605001	905156619001
305161600001	305 112 A	no longer available	905063630103	905122650001	-	905112605001	905156619001
305162600001	305 112 A	905130601001	921630630121	905122650001	-	905112605001	905156619001
305195600001	305 170	no longer available	905063630103	905191650001	-	-	-
305197600001	305 174	905174601001	905063630103	905191650001	-	-	-
305206600001	305 206	905208601001	905146630101	905205650001	-	-	-
305211600001	305 170	905235601001	921630630121	905170650001	-	-	-
305212600001	305 170	no longer available	921630630121	905170650001	-	-	-
305213600001	305 174	905235601001	921630630121	905170650001	-	-	-
305214600001	305 174	no longer available	921630630121	905170650001	-	-	-
305220600001	305 168	905208601001	905146630101	905168650001	-	-	-
305223600001	305 223	917016601090	903078630121	905222650001	-	-	-
305224600001	305 224	no longer available	914234630101	905222650001	-	-	-
305225600001	305 219	905219601001	903140630103	905219650001	-	-	-
305243600001	305 170	905269601005	905063630103	905243650001	-	-	-
305244600001	305 170	905174601001	905063630103	905243650001	-	-	-
305245600001	305 174	905269601005	905063630103	905243650001	-	-	-
305246600001	305 174	905174601001	905063630103	905243650001	-	-	-
305268600001	305 269	905235601001	921630630121	905269650001	921504608001	-	-
305269600001	305 269	905269601005	905063630103	905269650001	921504608001	-	-
305275600001	305 221	no longer available	921630630121	-	-	-	-
305276600001	305 221	905221601001	905219630103	905221650001	-	-	-
305277600001	305 258	917016601090	903078630121	905277650001	-	-	-
305290600001	305 269	no longer available	921630630121	905291650001	921504608001	-	-
305291600001	305 269	905174601001	905063630103	905291650001	921504608001	-	-
305300600001	305 300	916128601090	913183630121	905300650001	905300650002	-	-
305302600001	305 302	905208601001	905146630101	905302650001	921504608001	-	-
305303600001	305 269	905235601001	921630630121	905291650001	921504608001	-	-
305304600001	305 269	905174601001	921630630121	-	-	-	-
305305600006	305 305	905305601001	921630630121	905365650001	905305608001	-	905323608001
305309600001	305 309	923062601001	903137630101	905309650001	921504608001	-	-
305312600001	305 297	no longer available	921630630121	-	-	-	-
305314600001	305 297	921605601015	903137630101	905314650001	-	-	-
305323600001	305 305	905305601001	921630630121	905365650001	905305608001	-	905323608001
305330600001	305 170	905269601005	921630630121	905243650001	-	-	-
305331600001	305 170	905269601005	921630630121	905243650001	-	-	-
305332600001	305 302	905208601001	921630630121	905302650001	921504608001	-	-
305350600001	18.0204	920057601090	921630630121	-	-	-	-
305365600001	305 305	905365601001	921630630121	905365650001	905305608001	-	905323608001
305375600001	305 206	905208601001	921630630121	905205650001	-	-	-
305376600001	305 305	905365601001	921630630121	905323650001	905305608001	905323608001	-
305377600001	305 300	916128601090	921630630121	905300650001	905300650002	-	-
305380600001	305 296	905269601005	921630630121	-	-	-	-
305382600001	305 269	905269601005	921630630121	905291650001	921504608001	-	-
305384600001	305 384	907336601090	921630630121	905384650001	921504608001	-	-

Order no. towbar	Type	Spare part towball	Plug	Accessory bag	Socket holder	Mounting tube & other fastening parts	Holder for socket holders & other fastening parts
305398600001	305 269	905398601005	903137630101	905269650001	921504608001	-	-
305400600001	305 400	907305601090	913183630121	905400650001	921504608001	-	-
305403600001	321 848	921546601090	921630630121	921738650001	921541608002	-	-
305405600001	321 848	921546601090	921630630121	921738650001	921541608002	-	-
305407600001	305 407	921405601090	913183630121	905428650001	921504608001	-	-
305412600001	18.4246	920057601090	921630630121	-	932218608001	933051621009	-
305415600001	305 413	921605601015	903137630101	905314650001	-	-	-
305423600001	305 423	903189601090	913183630121	905421650001	921504608001	-	-
305425600001	305 305	905365601001	921630630121	905365650001	905368608001	-	905368608010
305429600001	305 429	907305601090	913183630121	905428650001	921504608001	-	-
305437600001	305 437	906271601001	903137630101	905314650001	921504608001	-	-
305442600001	18.4246	920057601090	921630630121	-	932218608001	933051621009	-
305445600001	305 305	905365601001	921630630121	905365650001	905305608001	-	905368608010
305447600001	305 447	903315601006	913183630121	905447650001	921504608001	933051621090	-
305465600001	AD61U	913082601090	913183630121	-	921504608001	933096621001	933096631001
305515600001	AD48BU	914251601090	913183630121	-	921504608001	-	-
305555600001	AD62U	913082601090	913183630121	905605650001	921504608001	933096621001	933096631001
305558600001	AD64AU	306245660001	913183630121	-	921504608001	933096621001	933096631001
305565600001	AD63U	913082601090	913183630121	905564650001	921504608001	933096621001	933096631001
305571600001	AD65U	914251601090	913183630121	-	921504608001	933096621001	933096631001
305580600001	AD68U	913082601090	913183630121	-	921504608001	933096621001	933096631001
305600600001	---	903273601090	921628630121	-	907292608001	-	-
305601600001	AD64BU	913082601090	913183630121	305601650001	921504608001	933096621001	933096631001
305603600001	AD64BU	916128601090	913183630121	305601650001	921504608001	933096621001	933096631001
305606600001	AD62AU	913082601090	913183630121	905605650001	921504608001	933096621001	933096631001
306128600001	306 128	906128601001	903011630108	906128650001	-	-	-
306160600001	306 160	no longer available	914234630101	906160650001	-	906160616101	-
306166600001	306 166	no longer available	903011630108	906160650001	-	-	-
306168600001	306 168	no longer available	914234630101	906164650001	-	-	-
306175600001	306 175	no longer available	921630630121	906176650001	-	-	-
306176600001	306 175	no longer available	903011630108	906176650001	-	-	-
306178600001	306 160	no longer available	921630630121	-	-	-	-
306182600001	306 168	no longer available	921630630121	-	-	-	-
306187600001	306 187	906187601090	903078630121	906187650001	-	-	-
306192600001	306 161	no longer available	921630630121	-	-	-	-
306195600001	306 161	no longer available	903011630108	906195650001	-	906195616101	-
306197600001	306 197	no longer available	903011630108	906197650001	-	-	-
306203600001	306 203	906203601002	903011630108	906203650001	-	906203616001	-
306205600001	306 168	no longer available	921630630121	-	-	-	-
306211600001	306 211	no longer available	903011630108	906211650001	-	-	-
306215600001	306 215	916165601090	903078630121	906222650001	-	906215619101	-
306217600001	306 217	906174601101	914234630101	906217650001	-	906217631001	-
306218600001	306 218	906230601003	903140630103	906230650001	-	-	-
306220600001	306 189 (A)	906172601001	914234630101	906189650001	-	906189616101	-
306222600001	306 215	916165601090	903078630121	906222650001	-	906215619101	-
306225600001	306 201	no longer available	921630630121	-	-	-	-
306226600001	306 201	no longer available	903011630108	906206650001	-	906201616001	-
306230600001	306 218	906230601003	903140630103	906230650001	-	-	-
306231600001	306 224	906224601090	903078630121	906231650001	-	-	-
306232600001	306 232	904060601002	903011630108	906228650001	-	-	-
306235600001	306 235	no longer available	903011630108	906234650001	-	-	-
306238600001	306 238	917016601090	913183630121	906241650001	-	-	-
306240600001	306 240	no longer available	913183630121	906246650001	-	-	-
306241600001	306 238	917016601090	913183630121	906241650001	-	-	-
306246600001	306 239	917016601090	913183630121	906246650001	-	-	-
306247600001	306 240	916165601090	913183630121	906246650001	-	-	-
306249600001	306 237	915055601001	913183630121	906249650001	-	-	-
306250600001	306 245	906245601005	913183630121	906250650001	-	-	-
306254600001	306 251	915055601001	913183630121	906254650001	-	-	-
306262600001	306 240	914294601090	913183630121	906246650001	-	-	-
306264600001	306 264	no longer available	903011630108	906228650001	-	-	-
306265600001	306 263	914294601090	903078630121	914257650001	921504608001	-	-
306266600001	306 252	921657601050	903078630121	906266650001	921504608001	-	-
306269600001	306 269	906224601090	913183630121	906268650001	-	-	-
306271600001	306 271	906271601001	903137630101	906270650001	-	906270609001	-
306275600001	306 275	915144601090	903078630121	906274650001	921504608001	-	-
306277600001	306 277	915144601090	913183630121	906276650001	921504608001	-	-
306279600001	306 215	916165601090	913183630121	906222650001	921504608001	906278619101	-
306286600001	306 286	915144601090	903078630121	906286650001	921504608001	-	-
306291600001	306 291	906224601090	913183630121	906290650001	-	-	-
306311600001	306 310	916211601001	916211630121	906311650001	921504608001	-	-
306319600001	306 319	no longer available	933034630101	906211650001	-	-	-
306321600001	306 320	917044601005	913183630121	906321650001	921504608001	-	-
306323600001	306 322	914294601090	913183630121	906323650001	921504608001	-	-
306333600001	306 333	932262601007	933034630101	906333650001	-	-	-
306350600001	306 337	906350601007	933034630101	906349650001	-	-	-
306353600001	306 353	932099601001	913183630121	906353650001	921504608001	-	-
306356600001	306 356	905305601001	921630630121	906355650001	-	-	-
306363600001	306 337	906350601007	921630630121	906349650001	-	-	-
306364600001	306 333	932262601007	921630630121	906333650001	-	-	-

Order no. towbar	Type	Spare part towball	Plug	Accessory bag	Socket holder	Mounting tube & other fastening parts	Holder for socket holders & other fastening parts
306367600001	?	921657601050	921630630121		932123608001	906231650001	9064605101 wechselfla
306369600001	306 361	916128601090	913183630121	906368650001	921504608001	-	-
306372600001	306 371	915144601090	903078630121	906372650001	921504608001	-	-
306374600001	306 374	914251601090	913183630121	906374650001	921504608001	-	-
306381600001	306 379	916220601007	933034630101	906381650001	-	-	-
306384600001	306 383	915144601090	913183630121	906384650001	921504608001	-	-
306387600001	306 471	906423601001	921630630121	906387650001	917102608001	-	-
306389600001	306 397	905305601001	921630630121	906389650001	921504608001	-	-
306391600001	02.4267	917034601005	921630630121	-	-	933051621090	-
306393600001	306 392	913082601090	921630630121	906393650001	-	-	-
306394600001	306 383	915144601090	913183630121	906384650001	921504608001	-	-
306400600001	306 398	914357601090	921630630121	906400650001	-	-	-
306405600001	306 470	914354601009	921630630121	906407650001	921504608001	-	-
306407600001	306 469	906423601001	921630630121	906407650001	921504608001	-	-
306427600001	306 485	906423601001	921630630121	-	-	-	-
306476600001	306 467	913082601090	921630630121	906476650001	921504608001	-	-
306491600001	306 446	906271601001	903137630101	906490650001	-	-	906490650001
306504600001	FT74AU	306245660001	913183630121	-	921504608001	933096621001	933096631001
306506600001	FT74AU	914251601090	913183630121	-	921504608001	933096621001	933096631001
306519600001	AL10U	932098601090	913183630121	-	921504608001	933096621001	933096631001
306535600001	CH26U	920057601090	913183630121	-	921504608001	933096621001	933096631001
307210600001	307 213	907213601090	903078630121	907210650001	-	-	-
307212600001	307 212	907212601005	921630630121	907200650001	-	-	-
307233600001	307 233	no longer available	914234630101	907233650001	-	-	-
307235600001	307 235	906187601090	903078630121	907235650001	-	-	-
307237600001	307 237	915055601001	903078630121	907237650001	-	-	-
307239600001	307 239	917016601090	903078630121	907239650001	-	-	-
307242600001	307 242	907245601090	903078630121	907242650001	921504608001	907241606001	-
307245600001	307 245	907245601090	903078630121	907245650001	921504608001	-	-
307247600001	307 245	907247601001	903078630121	907245650001	921504608001	-	-
307261600001	307 261	no longer available	921630630121	907269650001	-	-	-
307265600001	307 265	916128601090	913183630121	943038650001	-	-	-
307268600001	307 261	no longer available	921630630121	907269650001	-	-	-
307269600001	307 261	no longer available	903078630121	907269650001	-	-	-
307274600001	307 237	no longer available	921630630121	907237650001	-	-	-
307280600001	307 261	no longer available	921630630121	907269650001	-	-	-
307286600001	307 290	907286601007	933034630101	907286650001	-	-	-
307290600001	307 290	907286601007	933034630101	907286650001	-	-	-
307291600001	307 291	no longer available	933020630101	907291650001	-	-	-
307305600001	307 293	907305601090	913183630121	907305650001	921504608001	-	-
307308600001	307 296	921405601090	913183630121	907305650001	921504608001	-	-
307329600001	307 311	907329601090	921630630121	907329650001	921504608001	-	-
307330600001	307 312	921657601050	913183630121	907330650001	921504608001	-	-
307332600001	307 314	907329601090	921630630121	907329650001	921504608001	-	-
307333600001	307 315	915144601090	913183630121	907333650001	921504608001	-	-
307335600001	307 317	no longer available	921630630121	907329650001	921504608001	-	-
307336600001	307 318	907336601090	921630630121	907329650001	921504608001	-	-
307338600001	307 338	916128601090	913183630121	907338650002	-	-	-
307340600001	307 340	932223601090	913183630121	907339650001	921504608001	-	-
307343600001	307 343	916128601090	913183630121	907342650001	921504608001	-	-
307355600001	307 355	916165601090	913183630121	907355650001	921504608001	-	-
307356600001	307 356	907296601090	913183630121	907355650001	921504608001	-	-
307385600001	307 385	907296601090	942097630101	907382650001	-	-	-
307407600001	307 265	915055601001	903078630121	943038650001	921504608001	-	-
307408600001	307 338 N	916128601090	921630630121	907338650002	-	-	-
307430600001	08.5151	no longer available	900001005405	-	-	-	-
307432600001	307 293	907305601090	921630630121	907305650001	-	-	-
307433600001	307 317	no longer available	921630630121	907329650001	921504608001	-	-
307434600001	307 312	921657601050	921630630121	907330650001	921504608001	-	-
307436600001	307 265	915055601001	903078630121	943038650001	921504608001	-	-
307441600001	307 441	916128601090	913183630121	907402650001	932218608002	-	-
307449600001	F165AU	907200601005	921630630121	-	921504608001	933096621001	933096621001
307455600001	307 317	907335601001	921630630121	907329650001	921504608001	-	-
307458600001	307 458	913082601090	921630630121	907456650001	932218608002	-	-
307461600001	307 461	914357601090	921630630121	907402650001	932218608002	-	-
307463600001	307 463	914294601090	913183630121	907402650001	932218608002	-	-
307463600999	307 463	914294601090	921630630121	907402650001	932218608002	-	-
307464600001	08.4237	932276601090	921630630121	-	932218608001	933054621090	-
307474600001	08.4300	907213601090	913183630121	-	932218608001	933051621090	-
307476600001	307 476	914294601090	913183630121	-	932218608001	933051621090	-
307495600001	307 495	915226601090	921630630121	-	932218608001	933054621090	-
307497600001	307 480	907329601090	921630630121	907497650001	907480608002	-	-
307498600001	307 481	907498601001	921630630121	907497650001	907480608002	-	-
307501600001	307 501	916128601090	913183630121	907500650001	921504608001	-	-
307507600001	307 507	916128601090	913183630121	907402650001	932218608002	-	-
307522600001	307 522	913082601090	921630630121	-	-	-	-
307565600001	08.4237	932276601090	921630630121	-	932218608001	933054621090	-
307567600001	08.4300	907213601090	913183630121	-	932218608001	933051621090	-
307607600001	F180AU	917034601090	921630630121	-	921504608008	933096621001	933096631001
307637600001	F183U	306245660001	913183630121	907636650001	921504608001	933096621001	933096631001

Order no. towbar	Type	Spare part towball	Plug	Accessory bag	Socket holder	Mounting tube & other fastening parts	Holder for socket holders & other fastening parts
307639600001	F184U	917034601090	913183630121	907638650001	921504608001	933096621001	933096631001
307641600001	F185U	915144601090	913183630121		921504608001	933096621001	933096631001
307644600001	F186U	932098601090	913183630121		921504608001	933096621001	933096631001
307653600001	F182U	914251601090	913183630121	907652650001	921504608001	933096621001	933096631001
307659600001	F181AU	306245660001	913183630121	907658650001	921504608001	933096621001	933096631001
307673600001	307673600001	914357601090	921630630121	-	907292608001	-	-
313062600001	313 061 B	913062601001	903011630108	913061650001	-	913061617001	-
313082600001	313 082	913082601090	921630630121	913082650001	-	913082605002	913082650003
313082600006	313 082	913082601090	921630630121	913082650001	-	913082605002	913082650003
313090600001	313 090	no longer available	903011630108	913090650001	-	-	-
313117600001	313 117	906203601002	903011630108	913066650001	-	913066611001	-
313120600001	313 115	no longer available	903078630121	913120650001	-	913121611001	-
313129600001	313 129	913129601001	913183630121	913129650001	-	-	-
313131600001	313 131	no longer available	921630630121	-	-	-	-
313160600001	313 097	913097601009	903078630121	913097650001	-	913097650002	-
313167600001	313 167	916165601090	903078630121	913167650001	-	-	-
	313 172	913199601001	903078630121				
313174600001	313 164	917016601090	903078630121	913174650001	-	-	-
313176600001	313 165	913165601001	903078630121	913176650001	-	-	-
313179600001	313 179	913179601090	903078630121	913179650001	-	-	-
313179600006	313 179	913179601090	903078630121	913179650001	-	-	-
313183600001	313 129	913129601001	913183630121	913129650001	-	-	-
313189600001	313 189	913189601001	913183630121	913189650001	-	-	-
313192600001	313 192	913192601005	903137630101	913341650001	-	-	-
313195600001	313 195	916165601090	903078630121	913200650001	921504608001	-	913195650008
313200600001	313 200	921505601005	903078630121	913200650001	921504608001	-	-
313204600001	313 204	935268601001	913183630121	913195650001	921504608001	913195611001	913195650008
313211600001	313 211	916165601090	903078630121	913211650001	921504608001	913208611001	913195650008
313215600001	313 215	913192601005	921630630121	913341650001	-	-	-
313219600001	313 219	no longer available	921630630121	913129650001	-	-	-
313222600001	313 222	932099601001	903078630121	913222650001	921504608001	-	913222650009
313231600001	313 231	915055601001	903078630121	913195650001	921504608001	913231611001	913195650008
313234600001	313 196	no longer available	913183630121	913234650001	-	-	-
313239600001	313 232	913165601001	903078630121	913176650001	-	-	-
313241600001	313 115	916165601090	903078630121	913120650001	-	913121611001	-
313252600001	313 252	913252601090	921630630121	913211650001	921504608001	-	913195650008
313252600006	313 252	913252601090	921630630121	913211650001	921504608001	-	913195650008
313276600001	313 211	907296601001	903078630121	913211650001	921504608001	913208611001	913195650008
313286600001	313 097	913097601009	921630630121	913097650001	-	913097650002	-
313287600001	313 195	916165601090	921630630121	913195650001	-	913195650008	-
313288600001	313 204	935268601001	913183630121	913195650001	-	913195650008	913195611001
313289600001	313 232	913165601001	921630630121	913176650001	-	-	-
313290600001	313 167	916165601090	921630630121	913167650001	-	-	-
313314600001	313 231	915055601001	903078630121	913195650001	921504608001	913195650008	913231611001
313315600001	313 211	916165601090	921630630121	913211650001	921504608001	913195650008	913208511001
313340600001	313 192	913192601005	903137630101	913341650001	-	-	-
313345600001	313 215	913192601005	921630630121	913341650001	-	-	-
313361600001	09.4212	907329601090	921630630121	-	932218608001	933054621090	-
313369600001	313 252	913252601090	921630630121	913211650001	921504608001	913195650008	-
313373600001	09.4226	913082601090	921630630121	-	932218608001	933051621090	-
313375600001	313 211	916165601090	921630630121	913211650001	921504608001	913195650008	913208511001
313382600001	313 380	913165601001	903078630121	913176650001	-	-	-
313398600001	313 398	915055601001	913183630121	913396650001	921504608001	933051621090	-
313400600001	313 400	914294601090	913183630121	913396650001	921504608001	933051621090	-
313403600001	313 403	921405601090	913183630121	913402650001	921504608001	933051621090	-
313406600001	313 406	913406601005	903137630101	913405650001	-	-	913406609103
313421600001	313 215	913192601005	903137630101	913341650001	-	-	913406609103
313432600001	313 432	907305601090	913183630121	913431650001	921504608001	933051621090	-
313434600001	313 252	913252601090	921630630121	913211650001	921504608001	-	913195650008
313436600001	313 424	913436601001	921630630121	913435650001	-	-	-
313438600001	313 438	921505601005	903078630121	913438650001	921504608001	-	931195650008
313439600001	313 439	921405601090	903078630121	913438650001	921504608001	-	931195650008
313454600001	313222	932099601001	921630630121	913222650001	921504608001	-	-
313460600001	313460	916165601090	921630630121	913211650001	921504608001	913195650008	-
313461600001	313461	907296601001	921630630121	913211650001	921504608001	913195650008	-
313503600001	313 400	907245601090	913183630121	913396650001	921504608001	933051621090	-
313507600001	313 507	916128601090	913183630121	-	921504608001	933051621090	-
313515600001	313 515	913406601005	903137630101	913405650001	-	-	-
313524600001	MR67U	913082601090	913183630121	913523650001	921504608001	933096621001	933096631001
313556600001	MR61U	914294601090	913183630121	-	-	-	-
313562600001	MR66U	914294601090	913183630121	913561650001	921504608001	933096621001	933096631001
313640600001	MR70U	913082601090	913183630121	913639650001	921504608001	933096621001	933096631001
313662600001	MR71U	932098601090	913183630121	913661650001	921504608001	933096621001	933096631001
313710600001	MR896U	916128601090	913183630121	913710650001	921504608001	933096621001	933096631001
314234600001	314 234	no longer available	914234630101	914205650001	-	914205605001	-
314235600001	314 235	no longer available	914234630101	914235650001	-	914235605001	-
314244600001	314 244	no longer available	914234630101	914244650001	-	914244605001	-
314251600001	314 251	914251601090	913183630121	914251650001	-	914248605001	-
314254600001	314 254	no longer available	914234630101	914254650001	-	914224605001	-
314257600001	314 257	914257601090	903078630121	914257650001	-	914280605001	-

Order no. towbar	Type	Spare part towball	Plug	Accessory bag	Socket holder	Mounting tube & other fastening parts	Holder for socket holders & other fastening parts
314266600001	314 266	914266601001	903078630121	914266650001	-	-	-
314267600001	314 267	916128601090	903078630121	914267650001	-	-	-
314270600001	314 270	914270601001	913183630121	914270650001	-	-	-
314281600001	314 281	921505601005	913183630121	914281650001	-	-	-
314283600001	314 278	914283601001	903078630121	914283650001	-	-	-
314287600001	314 287	914294601090	903078630121	914285650001	921504608001	-	-
314289600001	314 289	915055601001	913183630121	914289650001	-	914289631001	-
314293600001	314 293	935268601001	913183630121	914293650001	921504608001	-	-
314295600001	314 294	914294601090	903078630121	914295650001	-	914295605001	-
314305600001	314 305	914266601001	913183630121	914305650001	921504608001	-	-
314307600001	314 307	916128601090	903078630121	914307650001	921504608001	-	-
314310600001	314 310	907245601090	913183630121	914310650001	921504608001	-	-
314341600001	10.4210	907305601090	913183630121	-	932218608001	933051621090	-
314342600001	10.4213	907305601090	913183630121	-	932218608001	933051621090	-
314345600001	314 287	914294601090	921630630121	914285650001	921504608001	-	-
314346600001	314 293	935268601001	913183630121	914293650001	921504608001	-	-
314372600001	314 357	914357601090	921630630121	914373650001	921504608001	-	-
314377600001	314289	915055601001	903078630121	914289650001	-	914289631001	-
314386600001	314 350	914350601001	921630630121	914386650001	907292608001	-	-
314392600001	314 391	914391601009	921630630121	914391650001	921504608001	-	-
314397600001	314 305	914266601001	921630630121	914305650001	921504608001	-	-
314406600001	314 353	914294601090	903078630121	914406650001	907292608001	-	-
314406600011	314 353	914294601090	921630630121	914406650001	907292608001	-	-
314409600001	10.4214	913082601090	921630630121	-	932218608001	933051621090	-
314414600001	314 352	914354601009	921630630121	914414650001	907292608001	-	-
314416600001	314 415	914357601090	921630630121	914416650001	907292608001	-	-
314420600001	314 371	907296601001	916114630120	914419650001	907292608001	-	-
314436600001	314 436	916128601090	913183630121	914307650001	921504608001	-	-
314437600001	314 354	914354601009	903078630121	914438650001	907292608001	-	-
314440600001	314 351	914357601090	921630630121	914440650001	907292608001	-	-
314448600001	314 444	914350601001	921630630121	-	-	-	-
314451600001	314 429	907296601001	913183630121	914451650001	907292608001	-	-
314461600001	40.4610	916165601090	913183630121	-	932218608001	933051621090	-
314470600001	314 459	914357601090	921630630121	914458650001	907292608001	-	-
314472600001	314 471	914294601090	903078630121	914472650001	907292608001	-	-
314473600001	314 464	914350601001	921630630121	914474650001	907292608001	-	-
314486600001	314 486	914266601001	913183630121	914305650001	921504608001	-	-
314500600001	314 287	914294601090	903078630121	914285650001	921504608001	-	-
314501600001	314 294	914294601090	903078630121	914295650001	921504608001	-	914295605001
314502600001	314 464	914350601001	921630630121	914474650001	907292608001	-	-
314503600001	314 354	914354601009	921630630121	914438650001	907292608001	-	-
314504600001	314 357	914357601090	921630630121	914373650001	921504608001	-	-
314505600001	314 415	914357601090	921630630121	914416650001	907292608001	-	-
314506600001	314 459	914357601090	921630630121	914458650001	907292608001	-	-
314507600001	314 391	914391601009	921630630121	914391650001	921504608001	-	-
314508600001	314 352	914354601009	921630630121	914414650001	907292608001	-	-
314509600001	314 351	914357601090	921630630121	914440650001	907292608001	-	-
314510600001	314 429	921405601090	913183630121	914451650001	907292608001	-	-
314513600001	314 488	914354601009	913183630121	914513650001	921504608001	-	-
314515600001	314 490	914493601005	921628630122	914515650001	914350600001	-	-
314540600001	314 429	921405601090	913183630121	914451650001	907292608001	-	-
314567600001	G121U	306245660001	913183630121	-	921504608008	933096621001	933096631001
314582600001	G125U	914294601090	913183630121	914581650001	921504608008	933096621001	933096631001
314584600001	G124U	913082601090	913183630121	914583650001	921504608008	933096621001	933096631001
314586600001	PG62U	914294601090	913183630121	914585650001	921504608008	933096621001	933096631001
314588600001	G127U	914294601090	913183630121	914587650001	921504608008	933096621001	933096631001
314597600001	PG66U	914251601090	913183630121	-	921504608008	933096621001	933096631001
314599600001	314599600001	914357601090	921630630121	-	907292608001	-	-
314601600001	G489	914294601090	913183630121	-	921504608001	933096621001	933096631001
314603600001	G901	907455601090	913183630121	914603650001	907292608001	-	-
314605600001	314605600001	907455601090	913183630121	914605650001	907292608001	-	-
315062600001	315 062	no longer available	903011630108	915062650001	-	915062619004	-
315074600001	315 074	915074601001	903011630108	915074650001	-	-	-
315076600001	315 076	no longer available	903011630108	915076650001	-	-	-
315080600001	315 080	no longer available	914234630101	915079650001	-	-	-
315084600001	315 083 (A)	no longer available	903011630108	915083650001	-	915083619001	-
315085600001	315 085	no longer available	903011630108	915085650001	-	-	-
315088600001	315 088	no longer available	903078630121	915088650001	-	-	-
315090600001	315 090	915055601001	913183630121	915090650001	-	-	-
315096600001	315 096	923045601005	903078630121	915095650001	-	-	-
315097600001	315 092	905112601001	903137630101	915097650001	-	-	-
315100600001	315 100	no longer available	903011630108	915100650001	-	-	-
315103600001	315 103	914251601090	913183630121	915103650001	921504608001	-	-
315105600001	315 105	907200601005	913183630121	915105650001	-	-	-
315107600001	315 107	916165601090	913183630121	915107650001	921504608001	-	-
315109600001	315 109	923045601090	903078630121	915109650001	921504608001	-	-
315114600001	315 111	915114601007	933034630101	915113650001	-	-	-
315115600001	?	915115601070	933034630101	-	921545608001	-	-
315119600001	SI 065	923045601005	921630630121	-	-	-	-
315148600001	SI 043	915144601090	921630630121	-	-	-	-

Order no. towbar	Type	Spare part towball	Plug	Accessory bag	Socket holder	Mounting tube & other fastening parts	Holder for socket holders & other fastening parts
315150600001	SI 115	906187601005	913183630121	-	-	-	-
315152600001	SI 078	906224601001	903078630121	-	-	-	-
315158600001	03.4599	914251601090	913183630121	-	932218608001	933051621090	-
315171600001	03.4026	916128601001	921630630121	-	932218608001	933051621090	-
315175600001	SI 160	914251601090	913183630121	-	-	-	-
315178600001	03.4604	914251601090	913183630121	-	932218608001	933051621090	-
315182600001	SI 160	917034601005	921630630121	-	-	-	-
315185600001	SI 163	915185601001	921630630121	-	-	-	-
315187600001	SI 118	on demand	913183630121	-	-	-	-
315188600001	03.4611	915144601090	921630630121	-	932218608001	933051621090	-
315190600001	SI 208	915144601090	921630630121	-	-	-	-
315201600001	30.104	no longer available	900001059080	-	-	-	-
315226600001	315 226	915226601090	921630630121	-	-	-	-
315244600001	315 226	915226601090	921630630121	-	921504608001	-	-
315246600001	SI237	915226601090	921630630121	-	-	-	-
315262600001	PG63AU	917034601090	913183630121	-	921504608001	933096621001	933096631001
315266600001	PG63AU	914294601090	913183630121	-	921504608001	933096621001	933096631001
315269600001	PG67U	914294601090	913183630121	-	921504608001	933096621001	933096631001
316097600001	316 097	906126601001	903011630108	916097650001	-	-	-
316100600001	316100	916100601001	903011630108	916100650001	-	-	-
316108600001	316 108	916108601001	903011630108	916107650001	-	-	-
316110600001	316 110	no longer available	914234630101	916109650001	-	916109619001	-
316112600001	316 112	no longer available	903011630108	916112650001	-	-	-
316114600001	316 114	916114601001	921630630121	916114650001	921504608001	-	-
316116600001	316 114	916114601001	921630630121	916114650001	921504608001	-	-
316117600001	316 117	916117601090	916114630120	916117650001	-	-	-
316137600001	316 137	913082601090	913183630121	916137650001	-	916137619001	-
316140600001	316 140	no longer available	913183630121	916140650001	-	916140619001	-
316142600001	316 142	917016601005	913183630121	916142650001	-	916142619001	-
316152600001	316 152	921406601005	913183630121	916152650001	-	-	-
316156600001	316 156	915144601090	903078630121	916155650001	-	916155619101	-
316159600001	316 140	no longer available	921630630121	916140650001	-	916140619001	-
316160600001	316 142	917016601005	921630630121	916142650001	-	916142619001	-
316162600001	316 145	917016601005	921630630121	916145650002	-	916145619001	-
316163600001	316 137	913082601090	921630630121	916137650001	-	916137619001	-
316166600001	316 166	906224601090	913183630121	916166650001	-	916166619101	-
316169600001	316 142	917016601090	921630630121	916142650001	-	916142619001	-
316170600001	316 170	916170601001	921630630121	916170650001	-	916143619001	-
316171600001	316 145	917016601090	921630630121	916145650002	-	916145619001	-
316176600001	316 176	914251601090	913183630121	916175650001	-	916175619101	-
316177600001	316 170	916170601001	913183630121	916177650001	-	916143619001	-
316186600001	316 128	916128601090	903078630121	916186650001	-	-	-
316192600001	316 189	907200601005	903078630121	916191650001	-	-	-
316194600001	316 165	916165601090	903078630121	916191650001	-	-	-
316197600001	316 199	916199601002	907286630001	916197650001	-	916199622001	907286626001
316207600001	316 207	906187601090	913183630121	916175650001	-	916206619101	-
316209600001	316 209	921505601005	913183630121	916209650001	-	-	-
316211600001	316 211	916211601001	921630630121	916213650001	-	-	-
316214600001	316 211	916211601001	916211630121	916213650001	-	-	-
316217600001	316 217	916217601002	907286630001	916216650001	-	916199622001	907286626001
316222600001	316 220	916220601007	933034630101	916222650001	-	-	-
316227600001	316 339	916225601001	921630630121	916226650001	921504608001	-	-
316252600001	316 250	916250601001	916211630121	916251650001	-	-	-
316262600001	SI 064	921441601005	921630630121	-	-	-	-
316265600001	SI 082	906224601001	903078630121	-	-	-	-
316267600001	SI 095	921556601005	921630630121	-	-	-	-
316269600001	SI 070	932262601007	921630630121	-	-	-	-
316273600001	SI 092	914251601090	913183630121	-	-	-	-
316278600001	SI 040	916250601001	921630630121	-	-	-	-
316284600001	SI 086	940067601007	921630630121	-	-	-	-
316287600001	SI 084	932262601007	921630630121	-	-	-	-
316291600001	SI 093	916298601007	921630630121	-	-	-	-
316294600001	SI 121	914251601090	913183630121	-	-	-	-
316297600001	SI 117	921556601005	921630630121	-	-	-	-
316307600001	SI 105	932262601007	921630630121	-	-	-	-
316310600001	SI 110	916276601001	921630630121	-	-	-	-
316312600001	SI 248	932262601007	921630630121	-	-	-	-
316315600001	SI 139	920057601090	921630630121	-	-	-	-
316320600001	SI 148	914251601090	913183630121	-	-	-	-
316322600001	SI 141	915144601090	921630630121	-	-	-	-
316324600001	SI 184	914251601090	913183630121	-	-	-	-
316326600001	316 325	916220601007	933034630101	916222650001	-	-	-
316334600001	SI 187	916335601001	921630630121	-	-	-	-
316335600001	SI 179	916335601001	921630630121	-	-	-	-
316337600001	SI 198	914294601090	921630630121	-	-	-	-
316342600001	SI 218	914294601090	921630630121	-	-	-	-
316344600001	SI 202	916276601001	921630630121	-	-	-	-
316355600001	SI 196	916335601001	921630630121	-	-	-	-
316359600001	SI 242	on demand	913183630121	-	-	-	-
316363600001	SI 203	921556601005	921630630121	-	-	-	-

Order no. towbar	Type	Spare part towball	Plug	Accessory bag	Socket holder	Mounting tube & other fastening parts	Holder for socket holders & other fastening parts
31636600001	SI 215	920057601090	921630630121	-	-	-	-
316387600001	SI 234	907245601001	903078630121	-	-	-	-
316388600001	RN117U	-	-	916388650001	921504608001	-	933096631001
316389600001	RN117U	306245660001	913183630121	916388650001	921504608001	933096621001	933096631001
316391600001	SI 239	on demand	913183630121	-	-	-	-
316407600001	SI 252	907245601090	913183630121	-	-	-	-
316431600001	RN115U	-	-	916431650001	921504608001	-	933096631001
316432600001	RN115U	914294601090	913183630121	916431650001	921504608001	933096621001	933096631001
316447600001	RN116U	-	-	-	921504608001	-	933096631001
316448600001	RN116U	915144601090	913183630121	-	921504608001	933096621001	933096631001
316453600001	RN118U	-	-	916453650001	921504608001	-	933096631001
316454600001	RN118U	914266601001	913183630121	916453650001	921504608001	933096621001	933096631001
316471600001	RN119U	-	-	916471650001	921504608001	-	933096631001
316472600001	RN119U	914266601001	913183630121	916471650001	921504608001	933096621001	933096631001
316481600001	RN120U	-	-	-	921504608001	-	933096631001
316482600001	RN120U	916128601090	913183630121	-	921504608001	933096621001	933096631001
316487600001	RN121	913082601090	913183630121	-	921504608001	-	-
316490600001	DA771U	-	-	-	921504608001	-	933096631001
316491600001	DA771U	913082601090	913183630121	913082601090	921504608001	933096621001	933096631001
316494600001	RN908U	-	-	916494650001	921504608001	-	933096631001
316495600001	RN908U	932098601090	913183630121	916494650001	921504608001	933096621001	933096631001
316497600001	SI 272	905342601001	-	-	-	-	-
316500600001	DA1440U	-	-	916500650001	921504608001	-	933096631001
316501600001	DA1440U	914266601001	913183630121	916500650001	921504608001	933096621001	933096631001
317016600001	317 017	917016601090	903078630121	917016650001	-	-	-
317034660001	317 034	917034601090	921630630121	-	-	-	-
317035600001	317 034	917034601090	903078630121	-	-	-	-
317036600001	317 036	913082601090	921630630121	917036650001	-	-	-
317040600001	317 034	917034601090	921630630121	-	-	-	-
317046600001	317 046	917016601005	903078630121	917046650001	-	-	-
317047600001	317 044	917044601005	903078630121	917044650001	-	-	-
317056600001	317 056	no longer available	903078630121	917056650001	-	-	-
317058600001	317 058	906224601090	903078630121	917056650001	-	-	-
317060600001	317 060	917016601090	903078630121	917046650001	921504608001	-	-
317064600001	317 064	921546601090	921630630121	921541650001	-	-	-
317066600001	317 066	921546601090	921630630121	917066650001	-	-	-
317075600001	317 058	906224601090	921630630121	917056650001	-	-	-
317079600001	317 077	917128601005	921630630121	917128650001	921504608001	-	-
317086600001	317 086	921546601090	921630630121	917086650001	-	-	-
317088600001	317 058	906224601090	903078630121	917088650001	-	-	-
317090600001	317 066	921546601090	921630630121	917066650001	-	-	-
317093600001	317 058	906224601090	921630630121	917088650001	-	-	-
317102600001	317 102	917088601090	921630630121	917088650001	917102608001	-	-
317105600001	317 077	917128601005	903078630121	917079650001	921504608001	-	-
317107600001	317 107	907336601090	921630630121	917106650001	921504608001	-	-
317114600001	317114	905405601001	921630630121	917086650001	921504608001	-	-
317117600001	317 077	917128601005	903078630121	917117650001	921504608001	-	-
317128600001	317 077	917128601005	903078630121	917128650001	921504608001	-	-
317130600001	317 130	907336601090	921630630121	917106650001	921504608001	-	-
317132600001	317 132	905405601001	921630630121	921738650001	921541608002	-	-
317134600001	SK31U	913082601090	913183630121	-	921504608001	933096621001	933096631001
317141600001	321 852	905405601001	921630630121	921862600001	932218608002	-	-
317157600001	VW82U	913082601090	913183630121	-	921504608001	933096621001	933096631001
317168600001	SK32U	913082601090	913183630121	-	921504608001	933096621001	933096631001
317170600001	SK33U	913082601090	913183630121	917169650001	921504608001	933096621001	933096631001
317172600001	SK34	913082601090	903078630121	-	932218608001	-	-
317174600001	---	935468601090	921630630121	-	907292608001	-	-
317184600001	---	903273601090	921630630121	-	907292608001	-	-
320040600001	320 040	920040601001	903078630121	920040650001	-	920040617001	920040609101
320042600001	320 042	906203601002	903011630108	920035650001	-	-	-
320044600001	320 044	no longer available	903011630108	920044650001	-	920036607101	920044609101
320045600001	320 045	-	-	920045650001	-	920036607101	920044609101
320050600001	320 050	906224601090	913183630121	920050650001	-	920049606001	-
320053600001	320 050	916165601090	913183630121	920050650001	-	920049606001	-
320054600001	320 054	-	-	920054650001	-	920054606001	-
320057600001	320 057	920057601090	903078630121	920057650001	-	-	-
320060600001	320 060	906224601090	903078630121	920065650001	921504608001	-	-
320062600001	?	907286601007	921630630121	-	921545608001	-	-
320064600001	13.4206	913252601001	921630630121	-	900001005347	933054621090	-
320066600001	320 060	915055601001	903078630121	920065650001	921504608001	-	-
320068600001	320 068	914251601090	913183630121	920068650001	921504608001	-	-
320072600001	13.4607	916165601090	913183630121	-	932218608001	933051621090	-
320075600001	13.4259	916165601090	913183630121	-	932218608001	933051621090	-
320076600001	13.4260	907296601090	913183630121	-	932218608001	933051621090	-
320080600001	320 068	907200601005	913183630121	920068650001	921504608001	-	-
320097600001	13.4239	907329601090	921630630121	-	932218608001	933054621090	-
320102600001	320 102	913252601090	921630630121	-	932218608001	933054621090	-
320108600001	13.4288	907305601090	921630630121	-	932218608001	933051621090	-
320112600001	320 112	907296601090	921630630121	-	932218608001	933051621090	-
320114600001	320 114	914251601090	913183630121	920068650001	921504608001	-	-

Order no. towbar	Type	Spare part towball	Plug	Accessory bag	Socket holder	Mounting tube & other fastening parts	Holder for socket holders & other fastening parts
320115600001	13.4305	913252601090	921630630121	-	932218608001	933054621090	-
320116600001	VL54U	-	-	920116650001	921504608001	-	933096631001
320117600001	VL54U	914251601090	913183630121	920116650001	921504608001	933096621001	933096631001
320118600001	13.0019	no longer available	900001059080	-	-	-	-
320119600001	13.6022	no longer available	900001059080	-	-	-	-
320167600001	VL54U	932098601090	913183630121	920116650001	921504608001	933096621001	933096631001
320169600001	VL56U	-	-	920169650001	921504608001	-	933096631001
320170600001	VL56U	932098601090	913183630121	920169650001	921504608001	933096621001	933096631001
320171600001	VL54U	-	-	920116650001	921504608001	-	933096631001
320172600001	VL54U	920057601090	913183630121	920116650001	921504608001	933096621001	933096631001
320173600001	VL54U	-	-	920116650001	921504608001	-	933096631001
320174600001	VL54U	306245660001	913183630121	920116650001	921504608001	933096621001	933096631001
320181600001	VL54U	-	-	920116650001	921504608001	-	933096631001
320182600001	VL54U	913082601090	913183630121	920116650001	921504608001	933096621001	933096631001
320187600001	---	906271601090	903137630101	-	907292608001	-	-
321330600001	321 330	907198601001	903078630121	921330650001	-	-	-
321399600001	321 399	921399601001	903011630108	921399650001	-	-	-
321405600001	321 405	921405601090	903078630121	921405650001	-	-	-
321407600001	321 407	no longer available	903011630108	921407650001	-	-	-
321408600001	321 408	921408601001	903011630108	921408650001	-	-	-
321423600001	321 423	921423601001	914234630101	921423650001	-	-	-
321426600001	321 423	921423601001	921630630121	921423650001	-	-	-
321441600001	321 439	921441601005	903078630121	921441650001	-	-	-
321452600001	321 451	no longer available	921630630121	921453650001	-	-	-
321453600001	321 451	no longer available	903078630121	921543650001	-	-	-
321468600001	321 468	913129601001	903078630121	921468650001	-	-	-
321500600001	321 490	no longer available	921630630121	-	-	-	-
321505600001	321 504	921505601005	903078630121	921505650001	-	-	-
321506600001	321 504	921505601005	921630630121	-	-	-	-
321508600001	321 507	921505601005	903078630121	921505650001	-	-	-
321523600001	321 522	921522601001	903078630121	921523650001	-	-	-
321525600001	321 495	921495601001	903137630101	921525650001	-	-	-
321526600001	321 495	921495601001	921630630121	-	-	-	-
321537600001	321 537	916128601090	903078630121	921537650001	921504608001	-	-
321540600001	321 540	916128601090	903078630121	921540650001	-	-	-
321543600001	321 541	921546601090	921630630121	921541650001	-	-	-
321545600001	321 534	no longer available	921630630121	-	-	-	-
321545900005	321 534	921545601019	921630630121	-	-	-	-
321546600001	321 534	921546601090	921630630121	921546650001	921546608001	-	-
321546600999	321 534	921546601090	921630630121	921546650001	921546608001	-	-
321556600001	321 556	921558600003	903078630121	921673650001	-	-	-
321605600001	321 490	921605601015	903137630101	921605650001	-	-	-
321626600001	321 626	921522601001	903078630121	921626650001	-	-	-
321629600001	321 628	no longer available	921630630121	-	-	-	-
321630600001	321 628	921546601090	921630630121	921630650001	-	-	-
321649600001	321 647	no longer available	921630630121	-	-	-	-
321651600001	321 647	921546601090	921630630121	921651650001	-	-	-
321658600001	321 556	921558600003	921630630121	-	-	-	-
321659600001	321 556	921657601050	903078630121	921659650001	-	-	-
321660600001	?	no longer available	921630630121	-	-	-	-
321670600001	321 490	no longer available	921630630121	-	-	-	-
321673600001	321 556	921657601050	903078630121	921673650001	-	-	-
321675600001	?	921441601005	921630630121	-	-	-	-
321686600001	321 490	921605601005	921630630121	921686650001	-	-	-
321689900011	321 490	921605601005	921630630121	-	-	-	-
321691600001	321 668	921691601005	913183630121	921691650001	-	-	-
316165600001	316 165	916165601090	913183630121	-	-	-	-
321700600001	321 700	921546601090	921630630121	921700650001	-	-	-
321717600001	321 647	921546601090	921630630121	921651650001	-	-	-
321718600001	321 504	921505601005	921630630121	921505650001	-	-	-
321719600001	321 537	916128601090	921630630121	921537650001	921504608001	-	-
321720600001	321 540	916128601090	921630630121	921540650001	-	-	-
321721600001	321 534	921546601090	921630630121	-	-	-	-
321722600001	321 628	921546601090	921630630121	921630650001	-	-	-
321728600001	321 728	903189601090	913183630121	921727650001	-	-	-
321730600001	321 730	903292601019	921630630121	921730650001	-	-	-
321736600001	321 490	921605601015	903137630101	921736650001	-	-	-
321738600001	321 848	921546601090	921630630121	921738650001	932218608002	-	-
321748600001	321 740	921748601001	903078630121	921741650001	921504608001	921740650001	-
321751600001	321 751	903292601019	921630630121	921751650001	-	-	-
321775600001	321 439	921441601005	903078630121	921775650001	921504608004	-	-
321778600001	321 769	921546601090	921630630121	921778650001	932218608002	-	-
321782600001	321 854	921546601090	921630630121	921854650001	932218608002	-	-
321783600001	321 556	921657601050	921630630121	921673650001	-	-	-
321784600001	321 728	903189601090	921630630121	921727650001	-	-	-
321786600001	321 751	903292601019	921630630121	921751650001	-	-	-
321815600001	321 815	905405601001	921630630121	921814650001	921504608001	-	-
321823600001	321 816	921546601090	921630630121	921823650001	-	-	-
321838600001	321 537	916128601090	913183630121	921537650001	921504608001	-	-
321843600001	?	903292601019	921630630121	-	-	-	-

Order no. towbar	Type	Spare part towball	Plug	Accessory bag	Socket holder	Mounting tube & other fastening parts	Holder for socket holders & other fastening parts
321863600001	321 852	921546601090	921630630121	921862600001	932218608002	-	-
321866600001	321 866	903292601019	921630630121	921865650001		-	-
321869600001	321 871	921546601090	921630630121	921868650001	932218608002	-	-
321873600001	321 873	903292601019	921630630121	921865650001		-	-
321878600001	321 740	921748601001	921630630121	921741650001	921504608001	-	921740650001
321879600001	321 740	auf Anfrage	921630630121			-	-
321885600001	321 866	903292601019	921630630121	921865650001		-	-
321907600001	321 907	913436601001	921630630121	921906650001	921504608001	-	-
321983600001	VW73U	913082601090	913183630121		921504608008	933096621001	933096631001
321991600001	VW73U	913082601090	913183630121		921504608008	933096621001	933096631001
322003600001	VW86U	916128601090	913183630121		921504608001	933096621001	933096631001
322055600001	VW90AU	913082601090	913183630121		921504608008	933096621001	933096631001
322056600001	VW95	329076600001	-		ZEP35	-	-
322064600001	VW96U	920057601090	913183630121	322063650001	921504608008	933096621001	933096631001
322070600001	VW90BU	913082601090	913183630121	922096650001	921504608008	933096621001	933096631001
322076600001	VW99U	914294601090	913183630121	322075650001	921504608001	933096621001	933096631001
322089600001	---	916128601090	913183630121		907292608001	-	-
322091600001	---	935468601090	921630630121		907292608001	-	-
322094600001	VW107	913252601090	921630630121		907292608001	-	-
322101600001	---	907335601001	921628630122		907292608001	-	-
322111600001	---	913252601090	921628630121		907292608101	-	-
322113600001	---	916128601090	921628630121		907292608001	-	-
322122600001	321 646	-	-	921651650001		-	-
322124600001	321 647	921628601001	921628630121	921651650001		-	-
322131600001	---		922131600101			-	-
322132600001	---		922131600101			-	-
306563600001	---		922131600101			-	-
313733600001	---		922131600101			-	-
323052600001	323 045	923045601090	905146630101	923052650001	-	-	-
323062600001	323 039	923062601001	923062630101	923062650001	-	923062650002	-
323063600001	323 051	329076600001	921630630121	923063650001	-	-	-
323079600001	323 079	907213601090	903078630121	923079650001	-	-	-
323080600001	323 080	923080601005	903078630121	923080650001	923080608002	-	-
323084600001	323 082	923045601090	903078630121	923084650001	921504608001	-	-
323097600001	323 097	923045601090	903078630121	923097650001	921504608001	-	-
323100600001	323 099	923045601090	903078630121	923084650001	921504608001	-	-
323102600001	23.4265	932276601090	921630630121	-	932218608001	933054621090	-
323107600001	323 107	921605601015	903137630101	923106650001	-	-	-
323107600011	323 107	921605601015	903137630101	923106650001	-	-	-
323121600001	323 121	921605601015	903137630101	923106650001	-	-	-
323121600011	323 121	921605601015	903137630101	923106650001	-	-	-
323141600001	323 141	913179601090	913183630121		932218608001	933051621090	-
323146600001	J19U	932098601090	913183630121		921504608001	933096621001	933096631001
323149600001	J17U	306245660001	913183630121		921504608001	933096621001	933096631001
323150600001	J17U	914251601090	913183630121		921504608001	933096621001	933096631001
323157600001	R54U	920057601090	913183630121		921504608001	933096621001	933096631001
323171600001	R55U	920057601090	913183630121		921504608001	933096621001	933096631001
323178600001	J20U	-	-	923178650001	921504608001	-	933096631001
323179600001	J20U	920057601090	913183630121	923178650001	921504608001	933096621001	933096631001
323181600001	R57U	920057601090	913183630121			933096621001	-
323189600001	R58U	-	-	923189650001	921504608001	-	933096631001
323190600001	R58U	914294601090	913183630121	923189650001	921504608001	933096621001	933096631001
323192600001	R59U	920057601090	913183630121		921504608001	933096621001	933096631001
324015600001	324 015 A	no longer available	914234630101	-	-	-	-
324019600001	324 019 A	no longer available	914234630101	924018650001	-	-	-
324021600001	324 021	924021601001	933020630101	-	-	-	-
324022600001	324 022	924022601007	933034630101	924022650001	-	-	-
324028600001	30.4249	914294601090	921630630121	-	921504608001	933051621090	-
327005600001	327 005	921605601015	903137630101	927014650001	-	-	-
327010600001	327 005	no longer available	921630630121	-	-	-	-
327014600001	327 005	921605601015	903137630101	927014650001	-	-	-
327023600001	327 023	-	-	927023650001	-	-	-
327033600001	327 005	no longer available	921630630121	927036650001	-	-	-
327036600001	327 005	921605601005	921630630121	927036650001	-	-	-
327068600001	327 068	907213601090	913183630121	-	932218608001	933051621090	-
332052600001	332 052	932052601001	921630630121	-	-	-	-
332058600001	332 052	932052601001	921630630121	-	-	-	-
332099600001	332 098	932099601001	921630630121	-	-	-	-
332119600001	332 119	915050601001	921630630121	932120650001	-	-	-
332121600001	332 121	915050601001	921630630121	932122650001	-	-	-
332122600001	332 121	915050601001	903011630108	932122650001	-	-	-
332123600001	332 123	no longer available	921630630121	932124650001	-	-	-
332124600001	332 123	no longer available	903011630108	932124650001	-	-	-
332134600001	332 134	no longer available	921630630121	932134650001	-	-	-
332135600001	332 134	no longer available	914234630101	932134650001	-	-	-
332154600001	332 153	no longer available	903078630121	932154650001	-	-	932154606101
332186600001	332 176	932186601001	903078630121	932186650001	-	-	-
332198600001	332 198	921691601005	903078630121	932198650001	-	-	-
332205600001	332 205	-	-	932205650001	-	-	-
332206600001	332 206	914251601090	913183630121	932205650001	-	-	-

Order no. towbar	Type	Spare part towball	Plug	Accessory bag	Socket holder	Mounting tube & other fastening parts	Holder for socket holders & other fastening parts
332207650001	332 207	-	-	932207650001	-	-	932195616001
332221600001	332 221	-	-	932221650001	-	-	-
332223600001	332 223	932223601090	903078630121	932223650001	-	-	-
332225650001	332 225	-	-	932225650001	-	-	-
332227600001	332 218	932218601005	903078630121	932227650001	932218608001	-	-
332228600001	332 220	-	-	932227650001	-	-	-
332230600001	332 229	-	-	932230650001	-	-	-
332232600001	332 231	907213601090	903078630121	932232650001	-	-	-
332234600001	332 233	-	-	932234650001	-	-	-
332235600001	332 235	907228601090	903078630121	932235650001	-	-	-
332237600001	332 237	-	-	932237650001	-	-	-
332239600001	332 238	-	-	932239650001	-	-	-
332241600001	332 240	932240601007	933034630101	932241650001	-	-	-
332245600001	332 245	-	-	932245650001	-	-	-
332246650001	332 246	-	-	932246650001	-	-	-
332247600001	332 247	907245601090	903078630121	932247650001	921504608001	-	-
332261600001	332 242	-	-	932261650001	-	-	-
332262600001	332 243	932262601007	933034630101	932262650001	-	-	-
332263650001	332 244	-	-	932263650001	-	-	-
332265600001	SI 132	932262601007	921630630121	-	-	-	-
332266600001	332 266	-	-	932246650001	-	-	-
332273600001	332 287	-	-	932273650001	-	-	-
332274600001	?	907228601090	921630630121	-	-	-	-
332296600001	31.4203	906187601005	913183630121	-	932218608001	933051621090	-
332303600001	332 289	932218601005	913183630121	932303650001	932218608002	-	-
332304600001	332 291	932276601090	921630630121	932304650001	921504608001	-	-
332305600001	332 292	932276601090	921630630121	932305650001	921504608001	-	-
332312600001	332 312	-	-	932312650001	-	-	-
332317600001	?	905305601001	921630630121	-	-	-	-
332318600001	?	933067601090	921630630121	-	-	-	-
332319600001	332 246	-	-	932319650001	-	-	-
332321600001	332 312	-	-	932321650001	-	-	-
332323600001	332 323	907213601090	913183630121	-	932218608001	933051621009	-
332324600001	?	932276601090	921630630121	-	-	-	-
332327600001	332 327	907245601090	903078630121	932247650001	921504608001	-	-
332330600001	332 330	915144601090	921630630121	-	-	-	-
332347600001	DT144AU	-	-	-	921504608008	-	933096631001
332348600001	DT144AU	914266601001	913183630121	-	921504608008	933096621001	933096631001
332353600001	DT148	329076600001	-	-	-	-	-
332359600001	DT152U	-	-	932359650001	921504608001	-	-
332360600001	DT152U	913082601090	913183630121	932359650001	921504608001	933096621001	-
332367600001	DT155	913082601090	913183630121	-	921504608001	-	-
332369600001	DT278U	913082601090	913183630121	932368650001	921504608001	933096621001	933096631001
335105600001	TY191U	-	-	935105650001	921504608001	-	933096631001
335106600001	TY191U	306245660001	913183630121	935105650001	921504608001	933096621001	933096631001
335129600001	335 129	no longer available	921630630121	-	-	-	-
335184600001	335 184	915055601001	921630630121	-	-	-	-
335201600001	335 203	no longer available	903011630108	935201650001	-	-	-
335203600001	335 203	no longer available	921630630121	-	-	-	-
335210600001	335 209	no longer available	903011630108	935208650001	-	-	-
335211600001	335 211	-	-	935211650001	-	-	-
335216600001	335 216	no longer available	914234630101	935216650001	-	-	-
335218600001	335 218	no longer available	903011630108	935218650001	-	-	-
335219600001	335 219	-	-	935219650001	-	-	-
335221600001	335 221	no longer available	903011630108	935221650001	-	-	-
335223600001	335 223	-	-	935223650001	-	-	-
335230600001	335 229	-	-	935230650001	-	-	-
335236600001	335 218	no longer available	921630630121	935218650001	-	-	-
335238600001	335 216	no longer available	921630630121	935216650001	-	-	-
335239600001	335 239	no longer available	913183630121	935239650001	-	-	-
335240600001	335 239	935239601001	916114630120	935239650001	-	-	-
335250600001	335 250	914259601005	903137630101	935250650001	-	-	-
335252600001	335 203	no longer available	921630630121	935201650001	-	-	-
335256600001	335 225	no longer available	921630630121	935225650001	-	-	-
335268600001	335 268	935268601001	921630630121	935268650001	-	-	-
335269600001	335 268	935268601001	921630630121	935268650001	-	-	-
335276600001	335 276	-	-	935276650001	-	-	-
335280650001	335 280	-	-	935280650001	-	-	-
335281600001	335 281	no longer available	903011630108	935281650001	-	-	-
335282600001	335 282	935282601001	933020630101	935282650001	-	-	-
335284600001	335 284	-	-	935284650001	-	-	-
335285600001	335 285	916128601090	913183630121	935284650001	-	-	-
335286600001	335 286	-	-	935286650001	-	-	-
335288600001	335 288	-	-	935288650001	-	-	-
335289600001	335 289	916128601090	913183630121	935288650001	-	-	-
335290600001	335 290	-	-	935290650001	-	-	-
335294600001	335 294	-	-	935394650001	-	-	-
335295600001	335 295	913179601090	913183630121	935294650001	-	-	-
335299600001	335 299	-	-	935299650001	-	-	-
335300600001	335 299	329062600001	-	935299650001	-	-	-

Order no. towbar	Type	Spare part towball	Plug	Accessory bag	Socket holder	Mounting tube & other fastening parts	Holder for socket holders & other fastening parts
335302600001	335 302	923045601090	913183630121	935301650001	-	-	-
335303600001	335 303	-	-	935301650001	-	-	-
335304600001	335 304	923045601090	913183630121	935301650001	-	-	-
335305600001	335 305	935305601001	913183630121	935305650001	-	-	-
335309600001	335 304	923045601090	921630630121	935301650001	-	-	-
335322600001	335 322	-	-	935322650001	-	-	-
335323600001	335 323	906187601090	913183630121	935322650001	-	-	-
335324650001	335 324	-	-	935324650001	-	-	-
335325600001	335 325	917034601090	913183630121	935325650001	-	-	-
335327600001	335 327	915114601007	933034630101	935327650001	-	-	-
335328600001	335 328	-	-	935328650001	-	-	-
335329600001	335 329	-	-	935329650001	-	-	-
335334600001	335 334	916117601090	921630630121	935352650001	921504608004	-	-
335344600001	16.4782	916128601090	913183630121	-	932218608001	933051621090	-
335346600001	16.4783	916128601090	913183630121	-	932218608001	933051621090	-
335348600001	335 325	917034601090	913183630121	935325650001	-	-	-
335350600001	335 350	-	-	935350650001	-	-	-
335351600001	335 351	-	-	935351650001	-	-	-
335352600001	335 333	-	-	935352650001	-	-	-
335353600001	335 334	916117601090	913183630121	935352650001	921504608004	-	-
335355600001	335 355	917016601090	913183630121	935355650001	-	-	-
335357600001	16.4603	920057601090	913183630121	-	932218608001	933051621090	-
335358600001	16.4609	913179601090	913183630121	-	932218608001	933051621090	-
335360600001	16.4781	921546601090	921630630121	-	900001005347	933054621090	-
335363600001	335 363	-	-	935363650001	-	-	-
335365600001	335 365	-	-	935363650001	-	-	-
335364600001	335 374	no longer available	903078630121	935363650001	-	-	-
335366600001	335 366	-	-	935366650001	-	-	-
335367600001	335 375	no longer available	903078630121	935366650001	-	-	-
335368600001	335 368	-	-	935366650001	-	-	-
335383600001	335 383	916128601090	913183630121	935383650001	921504608001	-	-
335384600001	335 294	-	-	935398650001	-	-	-
335392600001	335 392	-	-	935392650001	-	-	-
335393600001	335 376	no longer available	903078630121	935392650001	-	-	-
335394600001	335 394	-	-	935392650001	-	-	-
335397600001	335 299	-	-	935398650001	-	-	-
335398600001	335 295	913179601090	916114630120	935398650001	-	-	-
335400600001	335 400	-	-	935363650001	-	-	-
335408600001	335 328	-	-	935328650001	-	-	-
335409600001	335 328	-	-	935328650001	-	-	935409650001
335411600001	335 404	no longer available	903078630121	935363650001	-	-	-
335414600001	16.4786	907305601090	913183630121	-	932218608001	933051621090	-
335418600001	335 418	-	-	935418650001	-	-	335417630002
335419600001	335 417	935417601002	921630630121	935418650001	-	-	335417630002
335421600001	335 420	935374601001	903078630121	935636650001	-	-	-
335423600001	335 423	916128601090	913183630121	935423650001	921504608004	-	-
335424600001	335 424	-	-	935423650001	-	-	-
335425600001	335 425	915055601001	921630630121	935423650001	921504608004	-	-
335450600001	16.4787	no longer available	913183630121	-	932218608001	-	-
335455600001	335 383	916165601090	913183630121	935383650001	921504608001	-	-
335467600001	?	906423601001	921630630121	-	-	-	-
335495600001	335 495	917034601090	913183630121	-	921504608008	933096621001	933096631001
335504600001	TY165A	329076600001	-	-	-	-	-
335505600001	TY183A	329076600001	ZEP12	-	-	-	-
335510600001	TY195U	-	-	935510650001	921504608001	933096621001	933096631001
335511600001	TY195U	913082601090	913183630121	935510650001	921504608001	933096621001	933096631001
335512600001	TY194U	-	-	935512650001	921504608001	933096621001	933096631001
335513600001	TY194U	306245660001	913183630121	935512650001	921504608001	933096621001	933096631001
335514600001	TY197U	-	-	-	921504608001	933096621001	933096631001
335515600001	TY197U	914251601090	913183630121	-	921504608001	933096621001	933096631001
338038600001	338 038	938038601005	903137630101	938038650001	-	-	-
338056600001	338 044	938044601001	921630630121	938056650001	-	-	-
338057600001	338 046	-	-	938057650001	-	-	-
338058600001	338 048	938058601001	907286630001	938058650001	-	-	-
338059600001	338 050	no longer available	903011630108	938059650001	-	-	-
338064600001	338 063	-	-	938064650001	-	-	-
338062600001	338 061	no longer available	921630630121	938062650001	-	-	-
338066600001	35.4201	916128601090	913183630121	-	900001005347	-	-
338081600001	35.4596	916117601001	921630630121	-	932218608001	933051621090	-
338091600001	338 091	-	-	938091650001	-	-	-
338092600001	338 092	938092601007	933034630101	938091650001	-	-	-
338103600001	338 101	-	-	938104650001	-	-	-
338104600001	338 098	916117601090	913183630121	938104650001	921504608001	-	-
338108600001	35.4291	921546601090	921630630121	-	932218608001	933054621090	-
338110600001	338 110	913082601090	921630630121	-	932218608001	933051621090	-
338116600001	35.4295	916117601090	913183630121	-	932218608001	933051621090	-
338120600001	338 120	921657601050	913183630121	-	932218608001	933051621090	-
338126600001	338 126	916128601090	913183630121	-	900001005347	933051621090	-
338127600001	HN74U	-	-	-	921504608008	-	933096631001
338128600001	HN74U	914251601090	913183630121	-	921504608008	933096621001	933096631001

Order no. towbar	Type	Spare part towball	Plug	Accessory bag	Socket holder	Mounting tube & other fastening parts	Holder for socket holders & other fastening parts
338130600001	HN73U	-	-		921504608001	-	933096631001
338131600001	HN73U	916128601090	913183630121		921504608001	933096621001	933096631001
340037600001	340 037	913097601009	903078630121	940037650001	-	-	-
340039600001	340 039	903078601001	903078630121	-	-	-	-
340040600001	340 040	915055601001	905063630103	940040650001	-	-	-
340044600001	340 037	913097601009	921630630121	940037650001	-	-	-
340045600001	340 039	903078601001	903078630121	940039650001	-	-	-
340046600001	340 040	915055601001	903078630121	940040650001	-	-	-
340048600001	340 048	-	-	940048650001	-	-	-
340052600001	340 052	940052601001	903078630121	940052650001	-	-	-
340054600001	340 054	-	-	940054650001	-	-	-
340055600001	340 055	-	-	940055650001	-	-	-
340056600001	340 056	-	-	940056650001	-	-	-
340057600001	340 057	no longer available	921630630121	940057650001	-	-	-
340059600001	340 052	940052601001	921630630121	940052650001	-	-	-
340065600001	340 065	-	-	940065650101	-	-	-
340066600001	340 066	913199601001	913183630121	940066650001	-	-	-
340067600001	340 067	940067601007	933034630101	940067650001	-	-	-
340068600001	340 068	915115601070	933034630101	940068650001	-	-	-
340072600001	SI 060	914259601005	921630630121	-	-	-	-
340074600001	340 067	940067601007	933034630101	940067650001	-	-	-
340070600001	340 070	-	-	940070650001	-	-	-
340080600001	340 080	-	-	940080650001	-	-	-
340081600001	340 081	917016601090	913183630121	940081650001	921504608001	-	-
340093600001	37.4242	921546601090	921630630121	-	932218608001	933054621090	-
340094600001	37.4255	921546601090	921630630121	-	932218608001	-	-
340095600001	37.4240	921546601090	921630630121	-	-	-	-
340097600001	37.4272	921546601090	921630630121	-	932218608001	933054621090	-
340099600001	37.4286	907329601090	921630630121	-	932218608001	-	-
340131600001	CL127U	-	-	940131650001	921504608001	-	933096631001
340132600001	CL127U	916128601090	913183630121	940131650001	921504608001	933096621001	933096631001
341003600001	341 003	914259601005	903137630101	941003650001	-	-	-
341004600001	341 004	no longer available	914234630101	941004650001	-	-	-
341006600001	341 006	915114601007	933034630101	941006650001	-	-	-
341016600001	48.5248	915115601070	933034630101	-	-	-	-
341018600001	48.4254	914257601001	921630630121	-	932218608001	-	-
341021600001	48.4250	907228601005	903078630121	-	-	-	-
341024600001	48.4306	915144601090	913183630121	-	932218608001	-	-
341030600001	48.0179	no longer available	900001059080	-	-	-	-
341065600001	SZ26U	914251601090	913183630121	941065650001	921504608001	933096621001	933096631001
341066600001	SZ25	329076600001	-	-	900001005347	-	-
341067600001	SZ27Q	914259601005	942097630101	-	900001005347	-	-
341077600001	---	915144601090	913183630121	-	932218608001	-	-
342068600001	342 068	942068601002	914234630101	942068650001	-	-	-
342092600001	342 092	921505601005	903078630121	942092650001	-	-	-
342093600001	342 093	no longer available	903137630101	942093650001	-	-	-
342097600001	342 097	923062601001	903137630101			921426601001	945009650001
342098600001	342 098	914259601005	903137630101	950350350001	933096631001	946026650001 receiver tube 933096621001 or 933034621005	
342099600001	SI 046	914259601005	921630630121	935230650001	923105608001/ 923114608001	938092601007	946020650002/ 933096631001/ 933096621019
342103600001	342 103	920057601090	913183630121	942207650001/ 900105632554/ 900110632505/ 900110636182/ 900115632524/ 900120632516/ 900130632539/ 900130636185/ 900135632379	923105608001/ 923114608001/ 920036608001/ 907480608002	946154300013/933096621019/9151110608102/903186608001	933096631001
342105600001	SI 071	920057601090	921630630121	900040632340/ 900040636176/ 900045632325/ 900050632424/ 900050636186/ 900051351001/ 900055632552/ 900055636187/ 900060632523/ 900060636188/ 900095632553/ 900100632527/ 900100636180/ 900105632554/ 900110632505/ 900110632505/ 900115632524/ 900120632516/ 900130632539/ 900130636185/ 900135632379	903186608001/ 907480608002/ 914350608001/ 915110608102/ 920036608110/ 921259608101/ 921504608001/ 921504608002/ 921504608004/ 933034621005	906333621009/ 906350601007/ 933096621019/ 933096621001/ 938092601007	900010506616/ 933096631001

Order no. towbar	Type	Spare part towball	Plug	Accessory bag	Socket holder	Mounting tube & other fastening parts	Holder for socket holders & other fastening parts
342107600001	342 107	942107601007	933034630101	900040632340/ 900040636176/ 900045632325/ 900050632424/ 900050636186/ 900051351001/ 900055632552/ 900055636187/ 900060632523/ 900060636188/ 900095632553	913246608001/ 915110608102/ 932123608001/ 903186608001/ 907480608002/ 914350608001/ 917102608001/ 917102608001/ 921259608101/ 921504608001/ 921504608002/ 923105608001/ 923114608001/ 932218608001	906333621009/ 906350601007/ 933051621090/ 933054621090/ 906350601007/ 922038621009/ 922040621009/ 906333621009/ 906350601007/ 933096621001/ 933096621019/ 938092601007/ 906350601007/ 916220601007	906241650001/ 907289650001/ 933096631001
342113600001	SI 050	914259601005	921630630121	900040632340/ 900040636176/ 900045632325/ 900050632424/ 900050636186 900051351001/ 900055632552/ 900055636187/ 900060632523/ 900060636188/ 900095632553/ 900100632527/ 900100636180	903186608001/ 914350608001/ 915110608102/ 917102608001/ 920036608001/ 921259608101/ 921504608001/ 921504608002/ 921981608001/ 923105608001/ 923114608001/ 932218608001	906333621009/ 906350601007/ 907292608001/ 907480608002	900001506438/900010 506616
342121600001		914251601090	913183630121		921545608001		
342131600001	49.4200	932223601090	913183630121	900040632340/ 900040636176/ 900045632325/ 900050632424/ 900050636186/ 900051351001/ 900055632552/ 900055636187/ 900060632523/ 900060636188/ 900095632553	903186608001/ 907292608001/ 907480608002/ 914350608001/ 907480608002/ 917102608001/ 920036608001/ 921504608001/ 921504608002/ 921981608001/ 923105608001/ 923114608001/ 932218608001/ 903186608001/ 907292608001/ 914350608001/ 915110608102/ 917102608001/ 920036608001/ 921504608001/ 921504608002/ 921981608001/ 923105608001/ 923114608001/ 932218608001/ 945150300013	906333621009/ 906350601007/ 93809601008/ 938092601007/ 906333621009/ 906350601007/ 933034621005/ 933051621090/ 933054621090/ 933096621001/ 933096621019/ 938092601007/ 906350601007/ 906333621009/ 933034621005/ 933051621090/ 933054621090/ 933096621001/ 933096621019/ 938092601007	914052605002/ 933096631001/ 900010506616/ 903127650001/ 933096631001
342136600001	342 127	942127601001	916211630121				
342162600001	48.0128	942162601010					
342178600001	314 355	913252601090	921630630121				
342183600001	36.4263	906187601005	913183630121				
342185600001	49.4258	907336601090	921630630121				
342188600001	36.4612	916128601001	921630630121				
342189600001	05.4238	no longer available	913183630121				
342197600001	306 423	906423601001	921630630121				
342199600001	342 229	942127601001	921630630121				
342207600001	342 200	920057601090	913183630121				
342209600001	342 205	913179601090	913183630121				
342217600001	342 217	921546601090	921630630121				
342221600001	49.4309	907336601090	921630630121				
342235600001	49.0174	no longer available	900001059080				
342277600001		914251601090	913183630121				
342302600001	CH27U	914294601090	913183630121	942301650001	921504608001	933096621001	933096631001
343020600001	343 023 (A)	-	-	943020650001	-	-	943020606003
343024600001	343 024	no longer available	903078630121	-	-	-	-
343034600001	343 034	-	-	943034650001	-	-	-
343035600001		943035601001	921630630121				
343036600001	343 036	-	-	943034650001	-	-	-
343037600001	343 037	no longer available	933020630101	943037650001	-	-	-
343038600001	307 265	915055601001	913183630121	943038650001	921504608001	-	-
343039600001	343 039	-	-	943039650001	-	-	-
343040600001	343 040	916117601090	913183630121	943039650001	-	-	-
343043600001	343 043	no longer available	933034630101	943044650001	-	-	-
343044600001	343 044	no longer available	933034630101	943044650001	-	-	-
343045600001	343 045	-	-	943045650001	-	-	-
343047600001	343 046	906187601090	913183630121	943047650001	921504608001	-	-
343053600001	27.0277	-	-	-	900001005347	-	-
343056600001	27.4277	913082601090	921630630121	-	932218608001	933051621090	-
343058600001	27.4205	906187601005	913183630121	-	932218608001	933051621090	-

Order no. towbar	Type	Spare part towball	Plug	Accessory bag	Socket holder	Mounting tube & other fastening parts	Holder for socket holders & other fastening parts
343060600001	27.0154	-	-	-	900001005347	-	-
343063600001	343 061	907329601090	921630630121	943063650001	932218608002	-	-
343064600001	343 062	-	-	943063650001	-	-	-
343066600001	27.0236	-	-	-	900001005347	-	-
343067600001	27.4236	907296601090	913183630121	-	900001005347	933051621090	-
343070600001	27.0296	-	-	-	900001005347	-	-
343071600001	27.4296	913082601090	921630630121	-	932218608001	933051621090	-
343073600001	27.0311	-	-	-	900001005347	-	-
343072600001	343 072	-	-	943072650001	-	-	-
343074600001	27.4311	907329601090	921630630121	-	932218608001	-	-
343075600001	343 075	-	-	-	900001005347	-	-
343076600001	---	916128601090	913183630121	-	932218608001	933051621090	-
343078600001	27.4301	913082601090	921630630121	-	932218608001	933051621090	-
343079600001	343 079	-	-	943079650001	-	-	-
343080600001	27.4312	917034601090	913183630121	-	932218608001	933051621090	-
343081600001	27.0016	no longer available	-	-	-	-	-
343088600001	343 088	916128601090	913183630121	-	-	-	-
343097600001	MZ56U	913082601090	913183630121	-	-	-	-
343101600001	MZ57U	914294601090	913183630121	-	-	-	-
343105600001	MZ60U	913082601090	913183630121	-	-	-	-
343111600001	MZ57AU	-	-	943114650001	921504608001	-	933096631001
343112600001	MZ57AU	914294601090	913183630121	943114650001	921504608001	933096621001	933096631001
343114600001	MZ61U	306245660001	913183630121	943114650001	921504608001	-	933096631001
343115600001	MZ61U	306245660001	913183630121	943114650001	921504608001	933096621001	933096631001
343117600001	MZ62U	-	-	943117650001	921504608001	-	933096631001
343118600001	MZ62U	913082601090	913183630121	943117650001	921504608001	933096621001	933096631001
344008600001	344 006	344006601001	903011630108	944006650001	-	-	-
344012600001		907198601001	921630630121	-	-	-	-
344017600001	321 399	921399601001	921630630121	-	-	-	-
344024600001	344 024	917016601090	903011630108	944023650001	-	-	-
344025600001	344 025	-	-	944025650001	-	-	-
344027600001	344 027	944019601001	903011630108	944027650001	-	-	-
344028600001	344 027	944019601001	921630630121	944027650001	-	-	-
344030600001	344 024	917016601090	921630630121	-	-	-	-
344031600001	344 019	904060601002	903011630108	944031650001	-	-	944031650002
344036600001	321 439	921441601005	921630630121	-	-	-	-
344039600001	344 039	944039601005	903078630121	944039650001	-	-	-
344040600001	344 040	-	-	944040650001	-	-	-
344043600001	344 043	-	-	944043650001	-	-	-
344044600001	344 044	944044601001	913183630121	944044650001	-	-	-
344048600001	344 048	913082601090	921630630121	944048650001	-	-	-
344050600001	344 050	907198601001	921630630121	944050650001	-	-	-
344051600001	344 044	944044601001	921630630121	-	-	-	-
344052600001	344 050	903292601019	921630630121	-	-	-	-
344053600001	344 053	-	-	944054650001	-	-	-
344054600001	344 054	932099601001	905146630101	944054650001	921504608001	-	-
344060600001	344 060	903292601019	921630630121	944060650001	-	-	-
344073600001	344 053	-	-	944073650001	-	-	-
344074600001	344 074	932099601001	905146630101	944073650001	921504608001	-	-
344079600001	344 079	903292601019	921630630121	944060650001	-	-	-
344093600001	VW89AU	-	-	-	921504608001	-	933096631001
344094600001	VW89AU	920057601090	913183630121	-	921504608001	933096621001	933096631001
344101600001	SA24AU	-	-	-	921504608001	-	933096631001
344102600001	SA24AU	913082601090	913183630121	-	921504608001	933096621001	933096631001
344110600001	SA25U	-	-	944110650001	921504608001	-	933096631001
344111600001	SA25U	920057601090	913183630121	944110650001	921504608001	933096621001	933096631001
344120600001	SA26	913252601090	921630630121	-	907292608001	-	-
344123600001	SA29	913252601090	921630630121	-	907292608001	-	-
344124600001	SA26	903273601090	921630630121	-	907292608001	-	-
345003600001	345 001	906126601001	903011630108	945001650001	-	-	-
345014600001	345 014	-	-	945014650001	-	-	-
345016600001	345 016	914259601005	903137630101	945016650001	-	-	-
345020600001	345 020	-	-	945020650001	-	-	945020609001
345021600001	345 021	921691601005	903078630121	945020650001	-	-	945020609001
345023600001		914266601001	921630630121	-	-	-	-
345025600001		903292601019	921630630121	-	-	-	-
345026600001	345 026	932240601007	933034630101	945026650001	-	-	-
345027600001	345 027	-	-	945027650001	-	-	-
345028600001	345 028	914257601090	903078630121	945028650001	-	-	-
345035600001	345 035	-	-	945035650001	-	-	-
345036600001	345 036	915144601090	903078630121	945035650001	-	-	-
345037600001	345 037	-	-	945037650001	-	-	-
345038600001	345 038	-	-	945038650001	-	-	-
345039600001	345 039	935305601001	903078630121	945039650001	921504608001	-	-
345041600001	345 041	-	-	945041650001	-	-	-
345047600001		914257601090	921630630121	-	-	-	-
345059600001	345 028	914257601090	903078630121	945059650001	-	-	-
345062600001	345 039	935305601001	921630630121	-	-	-	-
345065600001	44.4207	907305601090	913183630121	-	932218608001	933051621090	-
345068600001	44.4220	921546601090	921630630121	-	900001005347	933054621090	-

Order no. towbar	Type	Spare part towball	Plug	Accessory bag	Socket holder	Mounting tube & other fastening parts	Holder for socket holders & other fastening parts
345069600001	44.0225	-	-	-	900001005347	-	-
345070600001	44.4225	907305601090	913183630121	-	932218608001	933051621090	-
345072600001	345 072	-	-	945018850001	-	-	-
345075600001	44.0216	-	-	900001005347	-	-	-
345077600001	44.4234	914251601090	913183630121	-	-	-	-
345078600001	44.8262	-	-	900001005347	-	-	-
345079600001	44.4251	917034601090	913183630121	-	-	-	-
345080600001	44.5262	942107601007	921630630121	-	-	933034621005	-
345081600001	44.8276	-	-	-	900001005347	-	-
345082600001	44.4276	916128601090	913183630121	-	932218608001	933051621090	-
345084600001	44.4264	906224601001	903078630121	-	-	-	-
345086600001	44.4283	914251601090	913183630121	-	932218608001	933051621090	-
345087600001	44.0268	-	-	-	900001005347	-	-
345088600001	44.0292	-	-	-	900001005347	-	-
345089600001	44.4292	914251601090	913183630121	-	932218608001	933051621090	-
345090600001	44.4285	906224601090	913183630121	-	932218608001	933051621090	-
345091600001	44.0304	-	-	-	900001005347	-	-
345092600001	44.4304	915144601090	913183630121	-	932218608001	-	-
345093600001	44.0294	-	-	-	900001005347	-	-
345094600001	44.4294	921546601090	921630630121	-	932218608001	933054621090	-
345096600001	345 096	907245601090	913183630121	-	932218608001	-	-
345111600001	345 111	-	-	-	900001005347	-	-
345112600001	345 112	914251601090	913183630121	-	932218608001	933051621090	-
345113600001	345 113	907305601090	913183630121	-	932218608001	933051621090	-
345115600001	345 115	906224601090	913183630121	-	932218608001	933051621090	-
345116600001	KA46U	-	-	903475650001	921504608001	-	933096631001
345117600001	KA46U	913082601090	913183630121	903475650001	921504608001	933096621001	933096631001
345118600001	345 118	-	-	-	900001005347	-	-
345119600001	345 119	907245601090	913183630121	-	921504608001	-	-
345126600001	KA45AU	-	-	-	921504608001	-	933096631001
345127600001	KA45U	306245660001	913183630121	-	921504608001	933096621001	933096631001
345128600001	KA41U	-	-	945128650001	921504608001	-	933096631001
345129600001	KA41U	914251601090	913183630121	945128650001	921504608001	933096621001	933096631001
345138600001	KA47U	-	-	945138650001	921504608001	-	933096631001
345139600001	KA47U	913082601090	913183630121	945138650001	921504608001	933096621001	933096631001
345140600001	KA48U	-	-	945140650001	921504608001	-	933096631001
345141600001	KA48U	917034601090	913183630121	945140650001	921504608001	933096621001	933096631001
345142600001	KA42AU	-	-	-	921504608001	-	933096631001
345143600001	KA42AU	913082601090	913183630121	-	921504608001	933096621001	933096631001
345144600001	KA49U	-	-	-	921504608001	-	933096631001
345145600001	KA49U	916128601090	913183630121	-	921504608001	933096621001	933096631001
345146600001	KA50U	-	-	945146650001	921504608001	-	933096631001
345147600001	KA50U	916128601090	913183630121	945146650001	921504608001	933096621001	933096631001
345151600001	KA51U	-	-	945151650001	921504608001	-	933096631001
345152600001	KA51U	914251601090	913183630121	945151650001	921504608001	933096621001	933096631001
345155600001	KA52U	-	-	-	921504608001	-	933096631001
345156600001	KA52U	914294601090	913183630121	-	921504608001	933096621001	933096631001
345165600001	KA53U	-	-	945165650001	921504608001	-	933096631001
345166600001	KA53U	932098601090	913183630121	945165650001	921504608001	933096621001	933096631001
345167600001	KA53AU	-	-	945167650001	921504608001	-	933096631001
345168600001	KA53AU	932098601090	913183630121	945167650001	921504608001	933096621001	933096631001
345171600001	KA1240U	-	-	945171650001	921504608001	-	933096631001
345172600001	KA1240U	932098601090	913183630121	945171650001	921504608001	933096621001	933096631001
345180600001	KA1443U	-	-	945180650001	921504608001	-	933096631001
345181600001	KA1443U	917034601090	913183630121	945180650001	921504608001	933096621001	933096631001
346015600001	346 015	-	-	946015650001	-	-	-
346016600001	346 016	923062601001	903137630101	946016650001	-	-	-
346017600001		no longer available	921630630121	-	-	-	-
346018600001	346 018	-	-	946018650001	-	-	-
346019600001	346 019	946019601001	903078630121	946019650001	921504608001	-	-
346020600001	346 020	-	-	946020650001	-	-	946020650002
346021600001	346 021	921405601090	913183630121	946021650001	921504608001	-	946020650002
346024600001	346 024	915114601007	933034630101	946024650001	-	-	-
346025600001	346 025	-	-	946025650001	-	-	-
346026600001	346 026	915144601090	913183630121	946026650001	-	-	-
346041600001	346 041	-	-	946041650001	-	-	-
346047600001	46.0208	no longer available	900001059080	-	-	-	-
346049600001	46.4232	907305601090	913183630121	-	-	-	-
346057600001	46.5591	no longer available	900001005405	-	-	-	-
346060600001	46.4222	914251601090	913183630121	-	-	-	-
346061600001		906187601005	913183630121	-	-	-	-
346064600001	46.4247	906224601090	913183630121	-	-	-	-
346066600001		915144601090	921630630121	-	-	-	-
346071600001	46.4271	914251601090	913183630121	-	932218608001	933051621090	-
346072600001	46.4270	914251601090	913183630121	-	-	-	-
346074600001	46.4282	914251601090	913183630121	-	932218608001	933051621090	-
346076600001	46.4287	921546601090	921630630121	-	-	-	-
346083600001	46.4281	915144601090	913183630121	-	-	-	-
346084600001	46.4284	906187601090	913183630121	-	-	-	-
346087600001	46.4313	913082601090	921630630121	-	-	-	-

Order no. towbar	Type	Spare part towball	Plug	Accessory bag	Socket holder	Mounting tube & other fastening parts	Holder for socket holders & other fastening parts
346088600001	46.4245	914251601090	913183630121				
346089600001	46.0545	no longer available	900001059080				
346093600001		921556601005	921630630121				
346104600001	346 104	907213601090	913183630121				
346106600001	346 106	921657601050	913183630121				
346111600001	HY66U	-	-		921504608001	-	933096631001
346112600001	HY66U	306245660001	913183630121		921504608001	933096621001	933096631001
346122600001	HY69U	916128601090	913183630121				
346123600001	HY66AU	-	-		921504608001	-	933096631001
346124600001	HY66AU	306245660001	913183630121		921504608001	933096621001	933096631001
346125600001	HY70U	-	-		921504608001	-	933096631001
346126600001	HY70U	914294601090	913183630121		921504608001	933096621001	933096631001
346127600001	HY70AU	-	-		921504608001	-	933096631001
346128600001	HY70AU	914294601090	913183630121		921504608001	933096621001	933096631001
346155600001	HY71U	-	-	946155650001	921504608001	-	933096631001
346156600001	HY71U	916128601090	913183630121	946155650001	921504608001	933096621001	933096631001
346157600001	HY72U	-	-	946157650001	921504608001	-	933096631001
346158600001	HY72U	914251601090	913183630121	946157650001	921504608001	933096621001	933096631001
346163600001	HY70BU	-	-	946163650001	921504608001	-	933096631001
346164600001	HY70BU	916128601090	913183630121	946163650001	921504608001	933096621001	933096631001
346165600001	HY73U	-	-		921504608001	-	933096631001
346166600001	HY73U	932098601090	913183630121		921504608001	933096621001	933096631001
346172600001	HY291U	916128601090	913183630121	946172650001	921504608001	933096621001	933096631001
346173600001	HY291U	-	-	946172650001	921504608001	-	933096631001
346175600001	HY1270	915144601090	913183630121	946175650001	921504608001	-	-
348012600001	348 012	906115601001	903011630108				
348014600001		948014601001	933020630101				
348016600001	348 016	914251601090	913183630121				
348018600001	348 018	907329601090	903078630121				
348020600001	38.4191	no longer available	900001005405	-	-	-	-
348022600001	38.4224	916128601001	921630630121				
348024600001	38.419	no longer available	900001005405				
348026600001	38.4218	907305601090	913183630121				
348028600001	38.4219	903189601090	913183630121				
348035600001	348 035	932099601001	913183630121				
348036600001	38.4289	917088601090	921630630121				
348036600011	38.4289	917088601090	921630630121				
348037600001	38.4266	907336601090	921630630121				
348037600011	38.4266	907336601090	921630630121				
348039600001	38.4290	913252601090	921630630121	-	932218608001	-	-
348039600011	38.4290	913252601090	921630630121	-	932218608001	-	-
348063600001	348 063	913252601090	921630630121	-	932218608001	933054621090	-
348063600011	348 063	913252601090	921630630121	-	932218608001	933054621090	-
348065600001	348 065	907305601090	913183630121		932218608001	933051621090	-
348076600001	SU43U	920057601090	913183630121	948077650001	921504608001	933096621001	933096631001
348078600001	SU43U	920057601090	913183630121	948077650001	921504608001	933096621001	933096631001
348080600001	SU44U	914294601090	913183630121	948079650001	921504608001	933096621001	933096631001
348080600011	SU44U	914294601090	913183630121	948079650001	907292608001	933096621001	933096631001
348084600001	SU45U	913252601090	921630630121		907292608001	-	-
348086600001	SU47U	913252601090	921630630121		907292608001	-	-
348088600001	SU1305U	914294601090	913183630121	948087650001	907292608001	933096621001	933096631001
349025600001	349 025	921546601090	921630630121	949025650001	921504608001	-	-
349026600001	349 026	-	-	949026650001	-	-	-
349027600001	349 027	921546601090	921630630121	949026650001	921504608001	-	-
349037600001	349 025	921546601090	921630630121				
349033600001	349 033	-	-	949033650001	-	-	-
349038600001	349 038	-	-	949038650001	-	-	-
349039600001	349 039	907213601090	903078630121	949038650001	921504608001	-	-
351008600001	---	906245601090	921628630121	-	907292608001	-	-

Wiring Kits

Accessories

Spare parts

Universal wiring kits (12 V on-board electrical systems)



Turn signal monitoring by flash unit with C2 function

Universally applicable for vehicles **without** Checkcontrol system, with European 3-pin replacement flash unit with C2 connection with rear fog light shutdown

order no.

300 060 300 107

300 060 300 113

300 061 300 113 (with adapter for deviant flash unit wiring)

300 096 300 163 (only wire set for vehicles with C2 feature)



Turn signal monitoring by control unit with double flashing rate

Universally applicable for vehicles **without** Checkcontrol system, with rear fog light and acoustic parking system shutdown

order no.

300 052 300 113 (socket with screw contacts, extended socket supplyline, e.g.: for flatbed)

300 072 300 107 (socket with screw contacts)

300 072 300 113 (socket with screw contacts)



Turn signal monitoring by control unit with acoustic error message

Universally applicable for vehicles **with** Checkcontrol system, partially also for vehicles with data bus technology (CAN), with rear fog light and parking system shutdown

order no.

300 210 300 113 (socket with screw contacts)

Extension kits



Continuous positive and charging line extension kit

Contains the connection for contact 9 and 10 acc. DIN/ISO 11446 incl. fuse and cut-off relay, 12 V

order no.: 300 025 300 113



10p CCM 506 079 (only complete kit)

Signal amplification for Checkcontrol, continuous positive necessary

order no.: 300 025 300 173



Electric Kit, towbar

(Catalogue identification "D1" in the 16 table column)
Contains the connection for contact 9 (13) acc. DIN/ISO 11446 incl. fuse.

order no.: 300 027 300 113



charging cable (extension kit)

(Catalogue identification "L1" in the 17 table column)
Contains the connection for contact 10 and 11 acc. DIN/ISO 11446 incl. fuse and cut-off relay, 12 V

order no.: 300 028 300 113



Rear fog light / Acoustic parking system switch-over kit

Contains a switch-over relay (12V)/ Connection accessories for changing the polarity of the specific function, for example earth-switched rear fog lights on the vehicle.

order no.: 300 065 300 005

Control units 12V – Signal strenghtening moduls



Identification no. (from the original control unit)		replaced by	part no.
506004	control unit 12V EJH		900001506004
506005	control unit ASTM-12		900001506005
506079	control unit CC-extension		900001506079
506244	control unit ASTM PRO -C1	X	900001506499
506274	control unit ALM 10/1		900001506274
506308	control unit ASG 2000-121	X	900001506274
506434	control unit ASG 2000-221		900001506434
506447	control unit ASG 2000-361		no longer available
506471	control unit Jaeger A52040211		no longer available
506472	control unit EJH 321132-W203		no longer available
506473	control unit EJH 321133-A4	X	900001506434
506499	control unit ASTM Pro V4		900001506499
506542	control unit ASTM 10		900001506542
506578	control unit ECS 5D033 (discontinued model)		900001506578
506623	control unit WAM ASTM-R		900001506623
506633	control unit WESTFALIA-Lightcontrol (LC)		900001506633
506723	control unit 14P. -5030		no longer available
506727	control unit Universal 58 231 021		no longer available
506730	control unit 10P TLM C2+54		no longer available
506848	control unit 14P 321059		900001506848
506857	control unit Vol. SIK 10		no longer available
506862	control unit 9P. 2(4)x21W 321054		no longer available
506906	control unit ASTM PRO B1		no longer available
506907	control unit ASTRA/ ZAFIRA UN17		900001506907
506974	control unit WAM vehicle tester (LCT)		900001506974
506978	control unit ASTM PRO A1	X	900001506499
507042	control unit ECS 5C040		900001507042 (discontinue model)
507044	control unit ASTM PRO V4 TD		900001507044
507059	control unit Lightcontrol (LC-L)-TD		no longer available
507075	control unit EJH 321112		900001507075
507082	control unit EJH 321113		900001507082
507085	control unit EJH 321114		900001507085
507091	control unit 14P. EH 9509		900001507091

Control units 12V – UCC-control units

control units that
are connected to the
CAN net



Example illustration for
UCC moduls

Identification no. (from the original control unit)		replaced by	part no.
506625	Uni CAN controll BMW UCC-1		900001506625
506626	Uni CAN controll PSA UCC-1 with buzzer		900001506626
506627	Uni CAN controll Ford UCC-1		900001506627
506628	Uni CAN controll Volvo UCC-1		no longer available
506629	Uni CAN controll Daimler UCC-1		900001506629
506630	Uni CAN controll VW UCC-1		900001506630
506631	Uni CAN controll Vauxhall UCC-1		900001506631
506632	Uni CAN controll Volvo UCC-2		no longer available
506668	Uni CAN controll Volvo UCC-3		900001506668
506669	Uni CAN controll Volvo UCC-4		no longer availabe
506670	Uni CAN controll MA/FO UCC-1		900001506670
506722	Uni CAN controll BMW UCC-3		no longer available
506737	Uni CAN controll BMW UCC-2		900001506625
506738	Uni CAN controll Ford UCC-2		900001506738
506796	Uni CAN controll PSA UCC-2		no longer available
506822	Uni CAN controll Daimler UCC-2		900001506822
506823	Uni CAN controll Fiat UCC-1 with buzzer		900001506823
506824	Uni CAN controll Fiat UCC 2		no longer available
506867	Uni CAN controll Ford UCC-4		900001506867
506964	Uni CAN controll PSA UCC-3		900001506964
507005	Uni CAN controll Renault UCC V-1		900001507005
507007	Uni CAN controll BMW UCC HV-1		900001507007
507040	Uni CAN controll Daimler UCC V4.0		900001507040
507043	Uni CAN controll Daimler UCC V3		900001507043
507062	Uni CAN controll Ford UCC 5		900001507062
507097	Uni CAN controll VW UCC 2		no longer available
507098	Uni CAN controll VW UCC 3		900001507098

Control units 12V – CAN-Module



Example illustration
for CAN-moduls

Identification no. (from the original control unit)		replaced by	part no.
506156	CAN control unit DC Hella 5DS 008 895		900001506156
506171	CAN control unit DC Hella 5DS 008 102		no longer available
506173	CAN control unit DC Hella 5DS 008 493		900001506173
506195	CAN control unit DC		no longer available
506229	CAN control unit DC		no longer available
506248	CAN control unit DC		no longer available
300001 506573	CAN control unit DC	X	900001506873
300001 506873	CAN control unit DC		900001506873

Control units 12V – CAN-Module



Example illustration
for CAN-moduls

Identification no. (from the original control unit)		replaced by	part no.
506077	CAN control unit AAGG	X	900001506758
506151	CAN control unit AAGG	X	900001506758
506153	CAN control unit AAGG	X	900001506758
506328	CAN control unit AAGG	X	900001506758
506352	CAN control unit AAGG	X	900001506758
300001 506553	CAN control unit AAGG	X	900001506758
300001 506558	CAN control unit AAGG	X	900001506758
300001 506658	CAN control unit AAGG	X	900001506758
300001 506758	CAN control unit AAGG		900001506758
300001 506194	CAN control unit AAGG	X	900001506653
300001 506557	CAN control unit AAGG		900001506557
300001 506560	CAN control unit AAGG		900001506560
300001 506561	CAN control unit AAGG	X	no longer available
300001 506562	CAN control unit AAGG		900001506653
300001 506569	CAN control unit AAGG		900001506569
300001 506667	CAN control unit AAGG		900001506667
300001 506687	CAN control unit AAGG		900001506569
300001 506697	CAN control unit AAGG		900001506697
300001 506821	CAN control unit AAGG		900001506821
300001 506710	CAN control unit AAGSG		900001506710
300001 506790	CAN control unit AAGSG		900001506790
300001 506869	CAN control unit AAGSG	X	900001506869
300001 506870	CAN control unit AAGS (discontinued model)		900001506870
300001 507025	CAN control unit AAGSG		900001506869
300001 507012	CAN control unit AAGSG		900001507012
300001 507014	CAN control unit AAGSG		900001507014
300001 507015	CAN control unit AAGSG		900001507015
300001 507016	CAN control unit AAGSG		900001507016

Relays 12 V



Rear fog light switch-off relay

30 = input (rear fog light switch)
87 a = open contact (rear fog light vehicle)
85 = output socket (rear fog light trailer)

order no.: 900 001 506 053



Turn signal (French)

4-pin (506 148)
C = 49 a output flash unit
+ = 49 input flash unit
- = 31 earth
R = C 1st indicator

order no.: 900 001 506 147



Amplifier up to 25A (changer)

(discontinued model)
1 = 86 = input control wire
2 = 85 = earth control wire
3 = 30 = input connecting contact
4 = 87a = opener connection contact 5
= 87 = closer connection contact

order no.: 900 001 506 186



Warning blinker switch with C2 function

(VW T4 07/98-)

order no.: 900 001 506 287



Amplifier up to 70A

(discontinued model)
1 = 86 = input control wire
2 = 85 = earth control wire
3 = 30 = input connecting contact 4 =
87a = opener connection contact 5 =
87 = closer connection contact

order no.: 900 001 506 464



Relay (Mini-model, e.g. Espace, Alfa, Fiat, ... (506 742))

1 = 86 = input control wire
2 = 85 = earth control wire
3 = 30 = input connecting contact
4 = 87a = opener connection contact
5 = 87 = closer connection contact

order no.: 900 001 506 742



Turn signal (European)

3-pin + C2 (506 811)
B = 49 input flash unit
L = 49 a output flash unit
E = 31 earth

order no.: 900 001 506 811

Relays 12 V



Turn signal (European) (kit with C2 light and cable)

3-pin + C2 (506 811)

B = 49 input flash unit

L = 49 a output flash unit

E = 31 earth

order no.: 900 002 506 811

Zuordnung Steuergeräte und Steckdosen

Elektrosatz	Identifikationsnummer	Ersatz-Blinkgeber	Steckdose	
			7-polig	13-polig
Bestell-Nr.		Bestell-Nr.	Bestell-Nr.	Bestell-Nr.
300025300173	Steuergerät 10p 506079	nur kpl. mit E-Satz		
300052300107/113	Steuergerät 12p ALM12/1/ASTM12/ASG2000-121	900001506005	900001506424	900001506439
300056300107/113	Steuergerät 30p 506 270 A	900001506499	900001506424	900001506439
300060300107/113	Blinkgeber 3p+2p C2 506 811	900001506811	900001506424	900001506680
300061300107/113	Blinkgeber 3p+2p C2 506 811	900001506811	900001506424	900001506680
300061300107/113	Adapter	900061305001		
300070300107/113	Steuergerät 10p ALM 10/1 (alt: 582070002)	900001506274	900001506424	900001506680
300071300107/113	Steuergerät 22p (58 231 024)	900001506104	900001506054	900001506387
300072300107/113	Steuergerät 12p ALM12/1/ASTM12/ASG2000-121	900001506005	900001506397	900001506001
300073300113	Steuergerät 12p ALM12/1/ASTM12/ASG2000-121	900001506005	-	900001506124
300076300107/113	Steuergerät 22p ASG 2000-221	900001506434	900001506424	900001506439
300077300107/113	Steuergerät 22p 506 434	900001506434	900001506424	900001506439
300077300107/113	Steuergerät 30p 506 270 A	900001506499	900001506424	900001506439
300078300107/113	Steuergerät ASTM pro V4 (alt: ASTM pro C1)	900001506499	900001506424	900001506439
300080300107/113	Blinkadapter EKS 2000	900001506811	900001506424	900001506680
300200300113	Blinkgeber 30p 506691	900001506691	-	900001506439
300201300113	Steuergerät 22p ASTM LC	900001506633	-	900001506439
300210300107/113	Steuergerät 22p ASTM LC	900001506633	900001506424	900001506439
303056300107/113	Blinkgeber 4p Westfalia	900001507786	900001506397	900001506680
303116300107/113	Blinkgeber 8p 54 220 003	900001506961	900001506424	900001506680
303117300107/113	Blinkgeber 8p 54 220 003	900001506961	900001506424	900001506680
303119300107/113	Blinkgeber 8p 54 220 003	900001506961	900001506424	900001506680
303120300107/113	Blinkgeber 8p 54 220 003	900001506961	900001506424	900001506680
303121300113	Steuergerät 15p 6 908 767	900001506563	-	900001506439
303122300113	Blinkgeber 8p 54 220 003	900001506961	-	-
303123300113	Steuergerät 15p 8 369 019 / 6 908 767	900001506563	-	900001506439
303124300113	Steuergerät 15p 8 369 019 / 6 908 767	900001506563	-	900001506439
303127300113	Steuergerät 15p 8 369 019 / 6 908 767	900001506563	-	900001506439
303137300113	Steuergerät 15p 8 369 019 / 6 908 767	900001506563	-	900001506680
303140300107/113	Steuergerät 15p 8 369 019 / 6 908 767	900001506563	900001506384	900001506439
303180300107/113	Steuergerät 12p ALM12/1/ASTM12/ASG2000-121	900001506005	900001506424	900001506439
303189300113	Steuergerät 15p 8 369 019 / 6 908 767	900001506563	-	900001506439
303202300113	Steuergerät ASTM pro V4 (alt: ASTM pro C1)	900001506499	-	900001506386
303205300113	Steuergerät ASTM pro V4 (alt: ASTM pro C1)	900001506499	-	900001506387

Zuordnung Steuergeräte und Steckdosen

Elektrosatz	Identifikationsnummer	Ersatz-Blinkgeber	Steckdose	
			7-polig	13-polig
Bestell-Nr.		Bestell-Nr.	Bestell-Nr.	Bestell-Nr.
303235300113	Steuergerät ASTM pro V4 (alt: ASTM pro C1)	900001506499	-	900001506386
303240300113	Steuergerät ASTM pro V4 (alt: ASTM pro C1)	900001506499	-	900001506387
303338300107/113	Steuergerät BMW (alt:UCC-3) UCC-2	900001506737	900001506397	900001506001
303352300107/113	Steuergerät BMW UCC-HV-1	900001507007	900001506424	900001506439
303368300113	Steuergerät BMW UCC-HV-1	900001507007	-	900001506439
303372300113	Steuergerät BMW UCC-HV-1	900001507007	-	900001506439
303372300113	Steuergerät BMW UCC-HV-1	900001507007	-	900001506607
303450300113	Steuergerät 18+10p 506577 (5F001)	900001506577	-	900001506439
303451300107/113	Steuergerät BMW (alt:UCC-1) UCC-2	900001506737	900001506424	900001506439
303460300107/113	Steuergerät BMW (alt:UCC-1) UCC-2	900001506737	900001506424	900001506439
303461300113	Steuergerät 18+10p 506577 (5F001)	900001506577	-	900001506439
303481300113	UCC2.0 HS BMW (301142)	900001508158	-	900001506439
303516300113		508187	-	auf Anfrage
304047300107/113	Blinkgeber 3p+2p C2 506 811	900001506811	900001506424	900001506680
304054300107/113	Steuergerät 12p ALM12/1/ASTM12/ASG2000-121	900001506005	900001506424	900001506439
304060300107/113	Blinkgeber 3p+2p C2 506 811	900001506811	900001506424	900001506680
304061300107/113	Steuergerät 12p ALM12/1/ASTM12/ASG2000-121	900001506005	900001506424	900001506439
304064300107/113	Steuergerät 12p ALM12/1/ASTM12/ASG2000-121	900001506005	900001506424	900001506439
304144300113	Steuergerät PSA (alt. UCC-2) UCC-3	900001506964	-	900001506001
304152300107/113	Steuergerät PSA (alt. UCC-2) UCC-3	900001506964	900001506397	900001506001
304157300113	Steuergerät PSA UCC-3	900001506964	-	900001506439
304157300113	Steuergerät PSA_UCC-3	900001506964	-	900001506439
304157300113	506694	900001506694	900001506424	900001506439
304203300107/113	UCC2.0 LS OPEL PSA	900001508153	900001506424	900001506680
304400300107/113	WA_PSA_UCC-1	900001506626	900001506548	900001506439
304401300107/113	WA_PSA_UCC-1	900001506626	900001506548	900001506439
304402300107/113	WA_PSA_UCC-1	900001506626	900001506548	900001506439
304510300107/113	Blinkgeber 3p+2p C2 506 811	900001506811	900001506424	900001506680
305155300107/113	Blinkgeber 3p+2p C2 506811	900001506811	900001506424	900001506680
305161300107/113	Steuergerät 8p 321099/321105/321106	900001506252	900001506397	900001506386
305171300107/113	Steuergerät ASTM pro V4 (alt: ASTM 30)	900001506499	900001506424	900001506439
305177300107/113	Steuergerät 12p ALM12/1/ASTM12/ASG2000-121	900001506005	900001506397	900001506001
305179300107/113	Steuergerät 14p 321095	900001506399	900001506054	900001506386
305180300107/113	Steuergerät 12p ALM12/1/ASTM12/ASG2000-121	900001506005	900001506397	900001506001

Zuordnung Steuergeräte und Steckdosen

Elektrosatz	Identifikationsnummer	Ersatz-Blinkgeber	Steckdose	
			7-polig	13-polig
Bestell-Nr.		Bestell-Nr.	Bestell-Nr.	Bestell-Nr.
305191300107/113	Steuergerät ASTM pro V4 (alt: ASTM 30)	900001506499	900001506424	900001506439
305205300107/113	Steuergerät 10+14+14op 321133	900001506473	900001506397	900001506001
305206300107/113	Steuergerät ASTM pro V4 (alt: ASTM 30)	900001506499	900001506397	900001506001
305207300107/113	Steuergerät 14p 321095	900001506399	900001506054	900001506386
305208300107/113	Steuergerät ASTM pro V4 (alt: ASTM pro C1)	900001506499	900001506397	900001506001
305209300107/113	Steuergerät ASTM pro V4 (alt: ASTM pro C1)	900001506499	900001506397	900001506001
305210300107/113	Steuergerät 5DS 008 408-10	900001506101	900001506397	900001506124
305212300107/113	Steuergerät 506205	900001506205	900001506397	900001506124
305213300107/113	Steuergerät 506205	900001506205	900001506397	900001506124
305213300107/113	Steuergerät 300001506653	900001506653	900001506054	900001506386
305214300107/113	Steuergerät 300001506562	900001506653	900001506397	900001506124
305215300107/113	Steuergerät 5DS 008 408-10	900001506653	900001506054	900001506386
305216300107/113	Steuergerät 300001506557	900001506557	900001506397	900001506124
305220300107/113	Steuergerät 14p 321095	900001506399	900001506054	900001506386
305221300107/113	Steuergerät 12p ALM12/1/ASTM12/ASG2000-121	900001506005	900001506397	900001506001
305222300107/113	Steuergerät 30p ASTM 30	900001506275	900001506397	900001506001
305223300107/113	Steuergerät 12p ALM12/1/ASTM12/ASG2000-121	900001506005	900001506397	900001506001
305224300107/113	Steuergerät 10+14+14op 321133	900001506473	900001506397	900001506001
305226300113	Steuergerät AAG	900001506765	-	900001506386
305227300113	Steuergerät AAG	900001506765	-	900001506124
305228300107/113	Steuergerät 30p ASTM 30	900001506499	900001506424	900001506439
305255300107/113	Steuergerät AAG	900001506328	900001506424	900001506124
305256300107/113	Steuergerät 300001506558	900001506558	900001506397	900001506124
305268300113	Steuergerät 300001506560	900001506560	900001506397	900001506124
305269300107	Steuergerät AAG	900001506765	900001506397	-
305269300113	Steuergerät AAG	900001506479	-	900001506124
305272300107/113	Steuergerät AAG	900001506327	900001506397	900001506124
305329300107/113	1K0.907.383.F	900001506658	900001506344	900001506123
305330300107/113	1K0.907.383.F	900001506658	900001506344	900001506123
305384300113	4H0.907.383.C	900001506663	-	900001506123
305385300113	4G8.907.383	900001506710	-	900001506123
305385300113	Steuergerät Ersatzteil 4G8.907.383	900001506710	-	900001506710
305386300113	4G8.907.383	900001506710	-	900001506123
305387300113	Steuergerät AAG 2. Gen. 4G8.907.383.B	900001507015	-	900001506607

Zuordnung Steuergeräte und Steckdosen

Elektrosatz	Identifikationsnummer	Ersatz-Blinkgeber	Steckdose	
			7-polig	13-polig
Bestell-Nr.		Bestell-Nr.	Bestell-Nr.	Bestell-Nr.
305403300107/113	Steuergerät AAG	900001506821	900001506397	900001506617
305404300107/113	Steuergerät AAG	900001506821	900001506397	900001506617
305406300107/113	Steuergerät AAG	900001506821	900001506397	900001506617
305407300107/113	Steuergerät AAG 2. Gen. 5Q0.907.383.L	900001507014	900001506548	900001506607
305407300107/113	.300001507014	900001507014	900001506397	900001506607
305408300107/113	Steuergerät AAG 2	900001507014	900001506397	900001506617
305408300107/113	.300001507014	900001507014	900001506397	900001506607
305410300107/113	Steuergerät 506758	900001506153	900001506397	900001506124
305417300107/113	Steuergerät VW UCC V3	900001507098	900001506424	900001506617
305418300113	UCC2.0 HS VW-AG1 (301173)	900001508151		900001506607
305437300113	Steuergerät AAGS 2. Gen. 4M0.907.383.F	900001506870	900001506424	900001506617
305437300107/113	Steuergerät AAGS 2. Gen. 4M0.907.383.F	900001506870	900001506424	900001506617
305466300113	Steuergerät AAGS 2. Gen. 4M0.907.383.F	900001506870	-	900001506607
305486300107/113	Steuergerät AAGS 2. Gen. 4M0.907.383.F	900001506870	900001506424	900001506607
305486300113	Steuergerät AAGS 2. Gen. 4M0.907.383.F	-		900001506607
305500300113	Steuergerät AAG	900001506569	-	900001506387
306126300113	Steuergerät 16p 58 231 021/12V	900001506727	-	900001506680
306142300107/113	Blinkgeber 3p+2p C2 506811	900001506811	900001506424	900001506680
306150300107/113	Blinkgeber 3p+2p C2 506811	900001506811	900001506424	900001506680
306151300107/113	Blinkgeber 3p+2p C2 506811	900001506811	900001506424	900001506680
306152300107/113	Blinkgeber 3p+2p C2 506811	900001506811	900001506424	900001506680
306153300107/113	Blinkgeber 3p+2p C2 506811	900001506811	900001506424	900001506680
306154300107/113	Blinkgeber 3p+2p C2 506811	900001506811	900001506424	900001506680
306174300107/113	Steuergerät 12p ALM12/1/ASTM12/ASG2000-121	900001506005	900001506424	900001506439
306175300107/113	Steuergerät 30p 506270	900001506499	900001506424	900001506439
306186300107/113	Steuergerät 30p 506270	900001506499	900001506424	900001506439
306189300113	Steuergerät 30p 506270	900001506499	-	900001506439
306197300107/113	Blinkgeber 4p Westfalia	900001507786	900001506424	900001506680
306201300107/113	Blinkgeber 4p Westfalia	900001507786	900001506424	900001506680
306203300113	Steuergerät 16p 58 231 021/12V	900001506727	-	900001506680
306204300107/113	Steuergerät 30p 506270	900001506499	900001506424	900001506439
306215300107/113	Steuergerät 30p 506270	900001506499	900001506424	900001506439
306216300107/113	Steuergerät 12p ALM12/1/ASTM12/ASG2000-121	900001506005	900001506424	900001506439
306217300001	Steuergerät ALM12/1/ASTM12/ASG2000-121	900001506005	-	-

Zuordnung Steuergeräte und Steckdosen

Elektrosatz	Identifikationsnummer	Ersatz-Blinkgeber	Steckdose	
			7-polig	13-polig
Bestell-Nr.		Bestell-Nr.	Bestell-Nr.	Bestell-Nr.
306218300113	Steuergerät 30p 506691	900001506691	-	900001506386
306220300113	Steuergerät ASTM pro V4 (alt: ASTM pro C1)	900001506499	-	900001506386
306221300107/113	Steuergerät ASTM pro V4 (alt: ASTM pro C1)	900001506499	900001506397	900001506386
306224300107/113	Steuergerät ASTM pro V4 (alt: ASTM 31)	900001506499	900001506397	900001506386
306226300107/113	Steuergerät 12p ALM12/1/ASTM12/ASG2000-121	900001506005	900001506424	900001506439
306227300107/113	Steuergerät 12p ASTM 12	900001506005	900001506424	900001506438
306231300107/113	Steuergerät ASTM pro V4 (alt: ASTM 31)	900001506499	900001506424	900001506439
306237300107/113	Steuergerät ASTM pro V4 (alt: ASTM 31)	900001506499	900001506397	900001506001
306238300107/113	Steuergerät ASTM pro V4 (alt: ASTM 31)	900001506499	900001506424	900001506439
306239300113	Steuergerät ASTM pro V4 (alt: ASTM 31)	900001506499	-	900001506439
306240300107/113	Steuergerät ASTM pro V4 (alt: ASTM 31)	900001506499	900001506424	900001506439
306249300107/113	Steuergerät ASTM pro V4	900001506499	900001506397	900001506124
306252300107/113	Steuergerät ASTM pro V4 (alt: ASTM 31)	900001506499	900001506397	900001506386
306254300113	Steuergerät ASTM pro V4	900001506499	-	900001506124
306260300113	Steuergerät 30p 506270 A	900001506499	-	900001506124
306263300107/113	Steuergerät 30p 506270 A	900001506499	900001506397	900001506001
306265300107/113	Steuergerät ASTM pro V4	900001506499	900001506424	900001506439
306271300107/113	Steuergerät ASTM pro V4	900001506499	900001506424	900001506439
306311300113	ET-Modul ASTM V4F	900001507231	-	auf Anfrage
306353300113	Steuergerät 30p 506270 A	900001506499	-	900001506001
306371300107/113	Steuergerät ASTM pro V4	900001506499	900001506397	900001506124
306374300107/113	Steuergerät ASTM pro V4	900001506499	900001506397	900001506001
306375300107/113	Steuergerät UCC-1 Fiat		900001506424	900001506001
306383300113	Steuergerät ASTM pro V4	900001506499	-	900001506439
306392300113	Steuergerät ASTM pro V4	900001506499	-	900001506439
306394300107/113	Steuergerät ASTM pro V4	900001506499	900001506424	900001506439
306397300107/113	Steuergerät ASTM pro V4	900001506499	900001506424	900001506438
306441300113	Steuergerät ASTM pro V4	900001506499	-	900001506001
306451300113	UCC2.0 HS FCA	900001507189	-	900001506124
306467300113	Steuergerät ASTM pro V4	900001506499		900001506710
306469300113	Steuergerät ASTM PRO V4	900001506499	-	900001506123
306507300107/113	Blinkgeber 3p+2p C2 506811	900001506811	900001506424	900001506680
306508300107/113	Blinkgeber 3p+2p C2 506811	900001506811	900001506424	900001506680
306510300107/113	Steuergerät 30p 506270 A	900001506499	900001506424	900001506439

Zuordnung Steuergeräte und Steckdosen

Elektrosatz	Identifikationsnummer	Ersatz-Blinkgeber	Steckdose	
			7-polig	13-polig
Bestell-Nr.		Bestell-Nr.	Bestell-Nr.	Bestell-Nr.
306520300113	Steuergerät 12p ASTM 10	900001506542	-	900001506387
306527300113	Steuergerät ASTM pro V4	900001506499	-	900001506124
306530300107/113	Steuergerät 506270 A	900001506499	900001506424	900001506439
306531300107/113	Steuergerät 506270 A	900001506499	900001506424	900001506439
306531300107/113	Steuergerät 30p ASTM pro V4	900001506499	900001506424	900001506439
306540300113	Steuergerät 30p (ASTM pro C1 alt) ASTM V4	900001506499	-	900001506439
306550300107/113	Steuergerät 30p (ASTM pro C1 alt) ASTM V4	900001506499	900001506397	900001506386
306560300113	Steuergerät 30p (ASTM pro C1 alt) ASTM V4	900001506499	-	900001506386
306570300113	Steuergerät 506270 A	900001506499	-	900001506386
306580300113	Steuergerät 506270 A	900001506499	900001506424	900001506439
306590300107/113	Steuergerät Lancia	900001506691	900001506424	900001506439
306592300113	Steuergerät 7p 58 227 001	900001506540	-	900001506387
306605300107/113	Steuergerät ASTM pro V4	900001506499	900001506424	900001506439
306606300113	Steuergerät 506270 A	900001506499	-	900001506001
306640300107/113	Steuergerät ASTM pro V4	900001506499	900001506424	900001506439
307120300107/113	Steuergerät 12p ALM12/1/ASTM12/ASG2000-121	900001506005	900001506397	900001506386
307121300107/113	Steuergerät 12p ASTM 10	900001506542	900001506424	900001506439
307122300113	Steuergerät 14p 321059	900001506848	-	900001506439
307162300107/113	Blinkgeber 3p+2p C2 506811	900001506811	900001506424	900001506680
307194300107/113	Blinkgeber 3p+2p C2 506811	900001506811	900001506424	900001506680
307200300107/113	Steuergerät 12p ASTM 12	900001506005	900001506397	900001506386
307231300107/113	Steuergerät 12p ASTM 12	900001506005	900001506397	900001506386
307232300107/113	Steuergerät 12p ASTM 12	900001506005	900001506424	900001506438
307234300107/113	Steuergerät 10p/12p 5C006 / ASTM 12	900001506398	900001506397	900001506001
307234300107/113	Steuergerät 10p/12p 5C006 / ASTM 12	900001506005	900001506397	900001506001
307240300107/113	Steuergerät 12p ALM12/1/ASTM12/ASG2000-121	900001506005	900001506397	900001506386
307242300107/113	Steuergerät 12p ALM12/1/ASTM12/ASG2000-121	900001506005	900001506424	900001506439
307244300107/113	Steuergerät 12p ALM12/1/ASTM12/ASG2000-121	900001506005	900001506424	900001506439
307260300113	Steuergerät 12p ASTM 10	900001506542	-	900001506387
307260300107/113	Steuergerät 12p ALM12/1/ASTM12/ASG2000-121	900001506005	900001506424	900001506439
307264300107/113	Steuergerät 12p ALM12/1/ASTM12/ASG2000-121	900001506005	900001506397	900001506439
307280300107/113	Steuergerät 12p ALM12/1/ASTM12/ASG2000-121	900001506005	900001506397	900001506386
307290300107/113	Steuergerät 12p ALM12/1/ASTM12/ASG2000-121	900001506005	900001506397	900001506001
307360300107/113	Steuergerät 12p ALM 12/1 ASTM 10	900001506542	900001506397	900001506386

Zuordnung Steuergeräte und Steckdosen

Elektrosatz	Identifikationsnummer	Ersatz-Blinkgeber	Steckdose	
			7-polig	13-polig
Bestell-Nr.		Bestell-Nr.	Bestell-Nr.	Bestell-Nr.
307376300113	Flash Control - (2+1)* 21 W	900001506786	-	
307385300107/113	Steuergerät Ford UCC-4	900001506867	900001506424	900001506439
307386300107/113	Steuergerät Ford UCC-4	900001506867	900001506424	900001506439
307397300107/113	Steuergerät ASTM LC	900001506633	900001506397	900001506001
307400300107/113	Steuergerät Ford UCC-1	900001506627	900001506424	900001506439
307402300107/113	Steuergerät Ford UCC-2 506738	900001506738	900001506397	900001506001
307402300107/113	Steuergerät Ford UCC-2 506738	900001506738	900001506424	900001506439
307442300107/113	Steuergerät Ford UCC-2 506738	900001506738	900001506397	900001506001
307473300107/113	Steuergerät Ford UCC-2 506738	900001506738	900001506397	900001506001
307474300107/113	Steuergerät Ford UCC-2 506738	900001506738	900001506397	900001506001
307478300107/113	Steuergerät Ford UCC-5 506738	900001507062	900001506397	900001506001
307489300113	508157	900001508157	-	900001506493
307490300113	508157	900001508157	-	900001506680
307495300113	Steuergerät	900001507163	-	-
307499300107/113	Steuergerät Ford UCC-5 506738	900001507062	900001506397	900001506001
307500300107/113	Steuergerät Ford UCC-2 506738	900001506738	900001506424	900001506439
307522300113	Steuergerät 5C040	900001507042	-	900001506439
307556300113	Steuergerät Ford UCC-5 506738	900001507062	-	900001506439
307573300113	Steuergerät	900001507042	-	900001506439
307575300113	Steuergerät Ford UCC-5	900001507062	-	900001506439
307576300107/113	UCC2.0 HS Ford Ka+	900001508155	900001506424	900001506680
307624300113	UCC2.0 HS Ford 02 (301176)	900001508157		900001506439
313004300107	Kontrolleinheit 58 211 001	900001507401	900001506424	-
313053300107/113	Steuergerät 13p 5DK 004 087-02	900001507900	900001506424	900001506680
313061300107/113	Steuergerät 7p 58 227 001	900001506540	900001506424	900001506680
313067600107/113	Steuergerät 7p 58 227 001	900001506540	900001506424	900001506680
313072300107	Steuergerät 12p ALM12/1/ASTM12/ASG2000-121	900001506005	900001506424	-
313082300107/113	Steuergerät ASTM pro V4 (alt: ASTM 30)	900001506499	900001506424	900001506680
313084300107/113	Steuergerät 14p+22p ASG 2000-361	900001506447	900001506424	900001506439
313084300107/113	Steuergerät 14p+22p 321132 PA66GS30	900001506472	900001506424	900001506439
313101300107/113	Steuergerät 7p 58 227 01	900001506540	900001506424	900001506680
313103300107/113	Steuergerät 12p ALM12/1/ASTM12/ASG2000-121	900001506005	900001506424	900001506439
313105300107/113	Steuergerät 5DS 008 769-10	900001506172	900001506424	900001506439
313107300113	Steuergeraet AAG A906 900 99 01	900001507050	-	auf Anfrage

Zuordnung Steuergeräte und Steckdosen

Elektrosatz	Identifikationsnummer	Ersatz-Blinkgeber	Steckdose	
			7-polig	13-polig
Bestell-Nr.		Bestell-Nr.	Bestell-Nr.	Bestell-Nr.
313108300113	Steuergerät AAG A9069009901	900001507050	-	900001506439
313116300107/113	kein Steuergerät erforderlich, im Bordnetz integriert	-	900001506054	900001506387
313117300107/113	nicht lieferbar	-	900001506397	900001506386
313120300107/113	Steuergerät 10p ALM 10/1 (alt: 58207002)	900001506274	900001506424	900001506680
313120300107/113	Steuergerät 12p ALM12/1/ASTM12/ASG2000-121	900001506005	900001506424	900001506439
313121300107/113	Steuergerät 30p (ASTM pro C1 alt) ASTM V4	900001506499	900001506397	900001506386
313122300107/113	Steuergerät 5DS 008 769-10	900001506172	900001506424	900001506439
313134300113	nicht erforderlich	-	-	900001506386
313135300113	nicht erforderlich	-	-	900001506439
313138300113	nicht erforderlich	-	-	900001506438
313167300107/113	Steuergerät 5DS 008 102-107	900001506171	900001506424	900001506439
313168300107/113	Steuergerät 5DS 008 769-10	900001506172	900001506692	900001506439
313174300107/113	Steuergerät 12p ALM12/1/ASTM12/ASG2000-121	900001506005	900001506397	900001506001
313176300107/113	Steuergerät 30p 506 270	900001506499	900001506424	900001506439
313195300107/113	-	-	900001506397	900001506001
313196300107/113	Steuergerät 5DS 008 493-107	900001506173	900001506397	900001506386
313208300107/113	Steuergerät 506 156	900001506156	900001506397	900001506439
313210300107/113	Steuergerät 506 156	900001506156	900001506397	900001506124
313211300107/113	Steuergerät 300001506573	900001506573	900001506397	900001506124
313212300107/113	Steuergerät 300001506573	900001506573	900001506397	900001506124
313215300113	UCC2.0 HS Mercedes	900001508160	-	900001506680
313217300113	UCC2.0 HS Mercedes	900001508160	-	900001507180
313231300107/113	Steuergerät Daimler UCC-2 506822	900001506822	900001506424	900001506123
313234300107/113	Steuergerät 12p ALM12/1/ASTM12/ASG2000-121	900001506005	-	900001506438
313361300107/113	Steuergerät Daimler UCC-1	900001506629	900001506397	900001506124
313386300143	Steuergerät Daimler UCC-1	900001506629	-	900001506124
313398300107/113	Steuergerät Daimler UCC-1	900001506629	900001506424	900001506124
313406300113	Steuergerät Daimler UCC-1	900001506629	-	900001506124
313430300113	Steuergerät Daimler UCC-1	900001506629	-	900001506124
313432300107/113	Steuergerät Daimler UCC-4	900001507040	900001506397	900001506124
313436300107/113	Steuergerät Daimler UCC-3	900001507043	900001506397	900001506001
313445300113	UCC2.0 HS Mercedes	900001508160	-	900001507180
313446300113	UCC2.0 HS Mercedes	900001508160	-	900001507180
314237300107/113	Steuergerät 12p ALM12/1/ASTM12/ASG2000-121	900001506005	900001506424	900001506439

Zuordnung Steuergeräte und Steckdosen

Elektrosatz	Identifikationsnummer	Ersatz-Blinkgeber	Steckdose	
			7-polig	13-polig
Bestell-Nr.		Bestell-Nr.	Bestell-Nr.	Bestell-Nr.
314244300107/113	Steuergerät 12p ALM12/1/ASTM12/ASG2000-121	900001506005	900001506424	900001506439
314245300107/113	Steuergerät 14p/12p 321095	900001506399	900001506054	900001506387
314245300107/113	Steuergerät 14p/12p ASTM 12	900001506005	900001506054	900001506387
314250300107/113	Blinkgeber 3p+2p C2 506811	900001506811	900001506424	900001506680
314251300107/113	Blinkgeber 3p+2p C2 509811	900001506811	900001506424	900001506680
314253300107/113	Blinkgeber 3p+2p C2 509811	900001506811	900001506424	900001506680
314254300107/113	Blinkgeber 3p+2p C2 509811	900001506811	900001506424	900001506680
314256300107/113	Blinkgeber 3p+2p C2 509811	900001506811	900001506424	900001506680
314257300107/113	Blinkgeber 3p+2p C2 509811	900001506811	900001506424	900001506680
314257300107/113	Steuergerät 12p ALM12/1/ASTM12/ASG2000-121	900001506005	900001506424	900001506439
314263300107/113	Steuergerät 12p ALM12/1/ASTM12/ASG2000-121	900001506005	900001506424	900001506439
314263300107/113	Steuergerät 12p ASTM R	900001506623	900001506424	900001506439
314264300107/113	Steuergerät 12p ALM12/1/ASTM12/ASG2000-121	900001506005	900001506424	900001506439
314265300107/113	Steuergerät 12p ALM12/1/ASTM12/ASG2000-121	900001506005	900001506424	900001506439
314267300113	Steuergerät ASTM R	900001506623	-	900001506439
314274300113	Steuergerät 321054 / 321130	900001506862	-	900001506439
314275300107/113	Steuergerät 321054 / 321130	900001506862	-	900001506439
314283300107/113	Steuergerät 30p ASTM pro A1/C1/V4	900001506499	900001506424	900001506439
314289300107/113	Steuergerät 12p ALM12/1/ASTM12/ASG2000-121	900001506005	900001506424	900001506439
314295300113	Steuergerät 16p nur beim Opel-Händler erhältlich	-	-	900001506439
314300300107/113	Steuergerät 244 538 50	900001506907	900001506424	900001506438
314307300107/113	Steuergerät ASTM LC	900001506633	900001506424	900001506439
314335300113	Steuergerät ASTM R	900001506623	-	900001506439
314342300107/113	WA Opel UCC-1	900001506631	900001506424	900001506439
314364300113	nicht erforderlich		-	
314373300113	Steuergerät ASTM 10	900001503907	-	900001506439
314386300107/113	WA_Opel_UCC-1	900001506631	900001506424	900001506439
314390300113	nur beim Opel-Händler erhältlich	-	-	900001506387
314400300107/113	Steuergerät 30p ASTM pro A1/C1/V4	90001506499	900001506424	900001506439
314402300113	nur beim Opel-Händler erhältlich	-	-	900001506387
314422300113	Steuergerät ASTM LC	900001506633	-	900001506439
314436300107/113	WA_Opel_UCC-1	900001506631	900001506424	900001506439
314451300107/113	Steuergerät ASTM LC	900001506633	900001506424	900001506439
314513300107/113	WA_Opel_UCC-1	900001506631	900001506397	900001506001

Zuordnung Steuergeräte und Steckdosen

Elektrosatz	Identifikationsnummer	Ersatz-Blinkgeber	Steckdose	
			7-polig	13-polig
Bestell-Nr.		Bestell-Nr.	Bestell-Nr.	Bestell-Nr.
314513300107/113	WA_Opel_UCC-1	900001506631	900001506424	900001506680
314514300107/113	WA Opel UCC-1	900001506631	900001506424	900001506680
314580300113	Steuergerät UCC2.0 Opel PSA	900001508153	900001506424	900001506680
314585300113	508153	900001508153	-	900001506439
314594300107/113	UCC2.0 LS OPEL PSA (300757)	900001508153	900001506054	900001506680
314595300113	508153	900001508153	-	900001506439
314596300113	508153	900001508153	-	900001506680
314860300107/113	Steuergerät ASTM R	900001506623	900001506054	900001506387
314870300107/113	Steuergerät ASTM R	900001506623	900001506424	900001506439
315072300107/113	Blinkgeber 3p+2p C2 506811	900001506811	900001506424	900001506680
315073300107/113	Blinkgeber 3p+2p C2 506811	900001506811	900001506424	900001506680
315097300107/113	Blinkgeber 3p+2p C2 506811	900001506811	900001506424	900001506680
315109300107/113	Steuergerät PSA UCC-1 506626	900001506626	900001506424	900001506439
315110300107/113	Steuergerät PSA UCC-1 506626	900001506626	900001506397	900001506001
315157300113	Steuergerät PSA UCC-3	900001506964	-	900001506439
315182300113	Steuergerät PSA UCC-3	900001506964	-	900001506001
315185300113	Steuergerät PSA UCC-3	900001506964	-	900001506001
315196300113	Steuergerät PSA UCC-3	900001506964	-	900001506001
316113300107/113	Steuergerät 12p ALM12/1/ASTM12/ASG2000-121	900001506005	900001506397	900001506001
316114300113	Steuergerät 10p ALM 10/1 (alt: 58207002)	900001506274	-	900001506001
316114300113	Steuergerät 12p ALM12/1/ASTM12/ASG2000-121	900001506005	-	900001506001
316117300113	Steuergerät 10p ALM 10/1 (alt: 58207002)	900001506274	-	900001506680
316117300113	Steuergerät 12p ALM12/1/ASTM12/ASG2000-121	900001506005	-	900001506439
316118300107/113	Steuergerät 12p ALM12/1/ASTM12/ASG2000-121	900001506005	900001506424	900001506439
316120300107/113	Blinkgeber 4p+2p C2 70 BGi000	900001506147	900001506424	900001506439
316123300107/113	Steuergerät 12p ALM12/1/ASTM12/ASG2000-121	900001506005	900001506424	900001506439
316124300107/113	Blinkgeber 5p 54 201 126	900001507731	900001506424	900001506680
316126300107/113	Blinkgeber 5p 54 201 126	900001507731	900001506424	900001506680
316128300107/113	ALM12/1/ASTM12/ASG2000-121	900001506005	900001506424	900001506680
316130300107/113	Steuergerät ASTM 10	900001506542	900001506424	900001506439
316135300113	kein Steuergerät	-	-	900001506387
316140300107/113	Steuergerät 12p ALM12/1/ASTM12/ASG2000-121	900001506005	900001506397	900001506001
316142300107/113	Steuergerät 12p ALM12/1/ASTM12/ASG2000-121	900001506005	900001506397	900001506001
316143300107/113	Steuergerät 12p ALM12/1/ASTM12/ASG2000-121	900001506005	900001506397	900001506001

Zuordnung Steuergeräte und Steckdosen

Elektrosatz	Identifikationsnummer	Ersatz-Blinkgeber	Steckdose	
			7-polig	13-polig
Bestell-Nr.		Bestell-Nr.	Bestell-Nr.	Bestell-Nr.
316152300113	Steuergerät 12p ALM12/1/ASTM12/ASG2000-121	900001506005	900001506397	900001506001
316156300107/113	Steuergerät 12p ASTM 10	900001506542	900001506424	900001506439
316170300107/113	Steuergerät 12p ALM12/1/ASTM12/ASG2000-121	900001506005	900001506397	900001506001
316174300107/113	Steuergerät 12p ALM12/1/ASTM12/ASG2000-121	900001506005	900001506397	900001506001
316174300107/113	Steuergerät 12p ASTM R	900001506623	900001506397	900001506001
316176300113	Steuergerät 10p TLM C2+54	900001506730	-	900001506680
316187300107/113	Steuergerät 12p ALM12/1/ASTM12/ASG2000-121	900001506005	900001506397	900001506001
316190300107/113	Steuergerät ASTM R	900001506623	900001506424	900001506439
316192300107/113	Steuergerät 12p ALM12/1/ASTM12/ASG2000-121	900001506005	900001506424	900001506439
316205300107/113	kein Steuergerät	-	-	900001506680
316207300113	Steuergerät 321054 / 321130	900001506862	-	900001506001
316214300107/113	Steuergerät ASTM R	900001506623	900001506424	900001506439
316252300113	Steuergerät ASTM R	900001506623	-	900001506001
316259300113	Steuergerät 10p TLM C2+54	900001506730		
316273300107/113	Steuergerät ASTM LC	900001506633	900001506424	900001506439
316290300107/113	Steuergerät ASTM LC	900001506633	900001506054	900001506387
316294300107/113	Steuergerät ASTM LC	900001506633	900001506424	900001506439
316297300107/113	Steuergerät 22p LC	900001506633	900001506424	900001506439
316300300107/113	kein Steuergerät	-	900001506054	900001506387
316312300107/113	Steuergerät 30p ASTM V4 TD	900001507044	900001506424	900001506439
316315300107/113	Steuergerät 10p 506623	900001506623	900001506424	900001506439
316318300113	kein Steuergerät	-	-	900001506721
316319300113	kein Steuergerät	-	-	900001506123
316321300113	Steuergerät ASTM LC	900001506633	-	900001506439
316333300107/113	Steuergerät ASTM LC	900001506633	900001506424	900001506439
316334300107/113	Steuergerät ASTM LC	900001506633	900001506424	900001506439
316337300107/113	Steuergerät Renault UCC V1	900001507005	900001506424	900001506439
316338300107/113	Steuergerät ASTM LC	900001506633	900001506424	900001506439
316340300107/113	Steuergerät ASTM LC	900001506633	900001506424	900001506439
316353300107/113	kein Steuergerät	-	900001506054	900001506387
316359300107/113	Steuergerät ASTM PRO V4_TD	900001507044	900001506548	900001506439
316366300113	Steuergerät ASTM 12	900001506005	-	auf Anfrage
316368300107/113	Steuergerät ASTM PRO V4_TD	900001507044	900001506548	900001506439
316403300113	Steuergerät 785087		-	900001506439

Zuordnung Steuergeräte und Steckdosen

Elektrosatz	Identifikationsnummer	Ersatz-Blinkgeber	Steckdose	
			7-polig	13-polig
Bestell-Nr.		Bestell-Nr.	Bestell-Nr.	Bestell-Nr.
316404300113	Steuergerät 30p ASTM V4 TD	900001507044	-	900001506439
316407300113	Steuergerät	900001507174	-	900001506439
316410300113	Steuergerät 10p 506623	900001506623	-	900001506001
316430300107/113	Steuergerät ASTM LC	900001506633	900001506397	900001506001
316434300107/113	Steuergerät ASTM LC	900001506633	900001506548	900001506439
316437300113	Steuergerät ASTM PRO V4_ TD	900001507044	-	900001506680
316440300107/113	kein Steuergerät	-	900001506054	900001506387
316442300107/113	Steuergerät 10p 900001506623	900001506623	900001506424	900001506439
316469300113	UCC2.0 HS Dacia Duster II	900001508154	900001506424	900001506680
316482300113	UCC2.0 HS RENAULT 2 (301474)	900001508165		900001506680
317007300107/113	Blinkgeber 4p Westfalia	900001507786	900001506424	900001506680
317013300107/113	Blinkgeber 4p Westfalia	900001507786	900001506424	900001506680
317015300107/113	Steuergerät 10p ALM 10/1 (alt: 58207002)	900001506274	900001506397	900001506001
317015300107/113	Steuergerät 12p ALM12/1/ASTM12/ASG2000-121	900001506005	900001506397	900001506001
317043300107/113	Steuergerät 12p ALM12/1/ASTM12/ASG2000-121	900001506005	900001506397	900001506001
317050300107/113	Steuergerät 12p ALM12/1/ASTM12/ASG2000-121	900001506005	900001506397	900001506001
317056300107/113	Steuergerät AAG (506328 alt) 506758	900001506758	900001506397	900001506617
317064300107/113	Steuergerät nicht erforderlich	-	900001506054	900001506617
317079300107/113	Steuergerät 506153	900001506153	900001506397	900001506617
317114300107/113	Steuergerät AAG2 300001507014	900001507014	900001506397	900001506607
317400300107/113	Steuergerät nicht erforderlich	-	900001506054	900001506617
317420300107/113	Steuergerät AAG 300001506758	900001506758	900001506397	900001506617
320039300107/113	Steuergerät nicht erforderlich	-	900001506424	900001506680
320044300107/113	Blinkgeber 3p+2p C2 506811	900001506811	900001506424	900001506680
320049300113	ohne Steuergerät/Lastrelais 506464	900001506464	-	900001506439
320051300113	Steuergerät 30p ASTM pro C1/V4	900001506499	-	900001506439
320058300113	Steuergerät 30p ASTM pro C1/V4	900001506499	-	900001506439
320076300107/113	Steuergerät Volvo UCC 3 506668	900001506668		900001506439
320102300107/113	Steuergerät 22p ASTM LC	900001506633	900001506424	900001506439
320108300107/113	Steuergerät ASTM LC	900001506633	900001506397	900001506001
320117300113	Steuergerät ASTM LC	900001506633	-	900001506439
320165300107/113	Steuergerät ASTM LC	900001506633	900001506548	900001506439
320173300107/113	UCC2.0 HS Volvo	900001508159	900001506424	900001506680
320187300113	Steuergerät EJH 321383	900001507356	-	auf Anfrage

Zuordnung Steuergeräte und Steckdosen

Elektrosatz	Identifikationsnummer	Ersatz-Blinkgeber	Steckdose	
			7-polig	13-polig
Bestell-Nr.		Bestell-Nr.	Bestell-Nr.	Bestell-Nr.
320240300107/113	Steuergerät 16p UCC 1 oder 3	900001506668	900001506424	900001506439
320320300113	Steuergerät 30p ASTM pro C1/V4	900001506499	-	900001506439
320400300113	Steuergerät 30p ASTM pro C1/V4	900001506499	-	900001506386
320540300113	Steuergerät 12p ALM12/1/ASTM12/ASG2000-121	900001506005	-	900001506001
320542300107/113	WA_Volvo_UCC-3	900001506668	900001506548	900001506438
320543300107/113	WA_Volvo_UCC-3	900001506668	900001506424	900001506680
320780300113	Steuergerät 12p ALM12/1/ASTM12/ASG2000-121	900001506005	-	900001506439
321044300113	Steuergerät VW UCC1 506630	900001506630	-	900001506124
321106300113	Steuergerät 5DS 008 769 - 107	900001506172	-	900001506439
321112300107/113	-	-	900001506424	900001506438
321113300107/113	Steuergerät AAG2 300001507012	900001507012	900001506424	900001506438
321315300107/113	Blinkgeber 3p+2p C2 506811	900001506811	900001506424	900001506680
321316300107/113	WBS 6NO 953 253 C	900001506287	900001506424	900001506680
321317300107/113	WBS 6NO 953 253 C	900001506287	900001506424	900001506680
321318300113	WBS 6NO 953 253 C	900001506287	900001506424	900001506680
321327300107/113	Blinkgeber 3p+2p C2 506811	900001506811	900001506424	900001506680
321331300107/113	Blinkgeber 3p+2p C2 506811	900001506811	900001506424	900001506680
321360300107/113	Blinkgeber 3p+2p C2 506811	900001506811	900001506424	900001506680
321361300107/113	Blinkgeber 3p+2p C2 506811	900001506811	900001506424	900001506680
321403300107/113	Blinkgeber 3p+2p C2 506811	900001506811	900001506424	900001506680
321451300107/113	ohne	-	900001506054	900001506387
321452300107/113	ohne	-	900001506054	900001506387
321454300107/113	Steuergerät 506758	900001506758	900001506054	900001506387
321455300107/113	Steuergerät 506558, 506658, 506758	900001506758	900001506054	900001506387
321456300107/113	Steuergerät 506558, 506658, 506758	900001506758	900001506054	900001506387
321457300107/113	Steuergerät 8p 321099/105/106	900001506252	900001506397	900001506001
321457300107/113	Steuergerät 12p 321099/105/106	900001506005	900001506397	900001506001
321458300107/113	Steuergerät 12p ALM12/1/ASTM12/ASG2000-121	900001506005	900001506397	900001506001
321465300107/113	Steuergerät 12p ALM12/1/ASTM12/ASG2000-121	900001506005	900001506397	900001506001
321468300107/113	WBS-Blinkgeber 1C0 953235 A	900001506022	-	900001506617
321500300113	Steuergerät AAG 506 107	900001506667	-	900001506439
321505300107/113	Steuergerät 12p ALM12/1/ASTM12/ASG2000-121	900001506005	900001506397	900001506001
321512300107/113	Steuergerät 12p ALM12/1/ASTM12/ASG2000-121	900001506005	900001506397	900001506001
321520300107/113	Steuergerät 12p ALM12/1/ASTM12/ASG2000-121	900001506005	900001506397	900001506001

Zuordnung Steuergeräte und Steckdosen

Elektrosatz	Identifikationsnummer	Ersatz-Blinkgeber	Steckdose	
			7-polig	13-polig
Bestell-Nr.		Bestell-Nr.	Bestell-Nr.	Bestell-Nr.
321523300113	ohne Steuergerät	-	-	900001506617
321524300107/113	ohne Steuergerät	-	900001506054	900001506617
321525300107/113	Steuergerät 506658, 506758	900001506758	900001506054	900001506387
321526300107/113	Steuergerät 12p ASTM 10	900001506542	900001506424	900001506439
321527300107/113	Steuergerät AAG 506658, 506758	900001506758	900001506397	900001506617
321529300107/113	Steuergerät AAG2 300001507012	900001507012	900001506397	900001506607
321534300107/113	Steuergerät AAG 506658, 506758	900001506758	900001506397	900001506617
321535300107/113	Steuergerät AAG 506658, 506758	900001506758	900001506397	900001506617
321537300107/113	Steuergerät AAG 506658, 506758	900001506758	900001506397	900001506617
321538300107/113	Steuergerät AAG 506658, 506758	900001506758	900001506397	900001506617
321539300107/113	Steuergerät 30p. ASTM PRO C1 / V4	900001506499	900001506397	900001506617
321540300107/113	Steuergerät AAG 506658, 506758	900001506758	900001506397	900001506617
321543300107/113	Steuergerät AAG 506658	506758, 900001506758	900001506397	900001506617
321545300107/113	Steuergerät AAG 506658, 506758	900001506758	900001506397	900001506617
321546300107/113	Steuergerät AAG 506658, 506758	900001506758	900001506397	900001506617
321554300107/113	Steuergerät AAG 506658, 506758	900001506758	900001506348	900001506438
321556300107/113	Steuergerät AAG 506658, 506758	900001506758	900001506054	900001506387
321557300107/113	Steuergerät 506658, 506758	900001506758	900001506054	900001506387
321600300107/113	Steuergerät 506658, 506758	900001506758	900001506397	900001506617
321650300113	Steuergerät 506758, 506758	900001506758	-	900001506387
321651300113	Steuergerät 506758	900001506758	-	900001506387
321652300113	-	-	-	900001506387
321653300113	-	-	-	900001506387
321661300113	-	-	-	900001506438
321681300113	Steuergerät UCC 2.0 LS VW-AG2	900001508179	-	auf Anfrage
321701300107/113	Steuergerät AAG 506658, 506758	900001506758		
321702300107/113	Steuergerät AAG 506658, 506758	900001506758	900001506054	900001506387
321704300107/113	Steuergerät 506758, 506758	900001506758	900001506054	900001506387
321705300113	Steuergerät AAG 300001506758	900001506758	-	900001506387
321765300113	Steuergerät AAG 7P0.907.383.B NAR	900001506660	900001506342	900001506438
321766300113	Steuergerät AAG2 300001507016	900001507016	-	900001506438
321780300107/113	Steuergerät VW UCC1 506630	900001506630	900001506397	900001506124
321863300107/113	Steuergerät VW UCC3 507098	900001507098	-	900001506617
321863300107/113	507098	900001507098	900001503424	900001506617

Zuordnung Steuergeräte und Steckdosen

Elektrosatz	Identifikationsnummer	Ersatz-Blinkgeber	Steckdose	
			7-polig	13-polig
Bestell-Nr.		Bestell-Nr.	Bestell-Nr.	Bestell-Nr.
322080300113			-	900001506607
322081300113			-	900001506607
323040300107/113	nicht erforderlich	-	900001506424	900001506680
323045300113	Steuergerät 15p 8 369 018/908 767	900001506563	-	900001506439
323048300107/113	ohne Steuergerät	-	90001506424	900001506680
323064300113	Steuergerät 15p 6 908 767	900001506563	-	900001506439
323074300113	nicht erforderlich	-	-	900001506437
323080300113	Steuergerät 30p (ASTM pro C1 alt) ASTM V4	900001506499	-	900001506124
323084300113	Steuergerät 506558	900001506558	-	900001506001
323097300113	Steuergerät BMW UUC2 506737	900001506625	-	900001506001
323102300113	nicht erforderlich	-	-	900001506617
323107300113	nicht erforderlich	-	-	900001506437
323141300113	nicht erforderlich	-	-	900001506439
323146300113	Steuergerät UCC	900001507150	-	900001507018
323189300113	UCC2.0 HS JLR 1 (301626)	900001508170		900001506439
323410300113	Steuergerät 506270 A	900001506499	-	900001506439
323411300113	nicht erforderlich	-	-	900001506607
324014300107/113	Steuergerät 14p 321095	900001506399	900001506054	900001506387
327014300113	Steuergerät 506 107	900001506107	-	900001506439
327068300113	Steuergerät AAG2 300001507016	900001507016	-	900001506001
332108300107/113	Steuergerät p3+2p C2 506811	900001506811	900001506424	900001506680
332262300107/113	Steuergerät ASTM LC	900001506633	900001506548	900001506439
332265300107/113	Steuergerät 12p ALM12/1/ASTM12/ASG2000-121	900001506005	900001506548	900001506439
332303300113	Steuergerät 5C018	nur kpl. mit E-Satz	-	900001506001
332305300113	Steuergerät ASTM LC	900001506633	-	900001506001
332306300113	Steuergerät 10p ASTM R	900001503907	-	900001506439
332314300113	Steuergerät ASTM LC	900001506633	-	900001506001
332327300107/113	Steuergerät ASTM LC	900001506633	900001506397	900001506001
332354300113	ET-Steuergerät Ejh 321264	900001507131	-	auf Anfrage
332366300113	Steuergerät ASTM LC	900001506633	-	900001506439
332367300113			-	900001506680
332400300107/113	Steuergerät 30p (ASTM 30 alt) ASTM V4	900001506499	900001506424	900001506439
332680300113	Steuergerät 10p 506079	nur kpl. mit E-Satz	-	900001506387
335110300113		-	-	-

Zuordnung Steuergeräte und Steckdosen

Elektrosatz	Identifikationsnummer	Ersatz-Blinkgeber	Steckdose	
			7-polig	13-polig
Bestell-Nr.		Bestell-Nr.	Bestell-Nr.	Bestell-Nr.
335229300113	Steuergerät 10p ASTM 10	900001506542	-	900001506438
335250300113	Steuergerät 10p ASTM R	900001506623	-	900001506439
335251300107/113	Steuergerät 10p ASTM 10	900001506542	900001506424	900001506439
335289300113	Steuergerät p3+2p C2 506811	900001506811	-	900001506439
335289300113	Flash Control - (2+1)*21 W	900001507786	-	900001506680
335299300113	Flash Control - (2+1)*21 W	900001507786	-	900001506680
335302300113	Steuergerät 10p ASTM 10	900001506542	-	900001506617
335303300113	Steuergerät 10p ASTM 10	900001506542	-	900001506617
335304300113	Steuergerät 10p ASTM 10	900001506542	-	900001506617
335305300113	Steuergerät 30p 506270 A	900001506499	-	900001506617
335323300113	Steuergerät 10p ASTM 10	900001506542	-	900001506617
335328300107/113	Steuergerät 12p ALM12/1/ASTM12/ASG2000-121	900001506005		900001506438
335345300113	Steuergerät ASTM V4	900001506499	900001506397	900001506001
335346300113	Steuergerät 5C028	900001506578	-	900001506439
335357300107/113	Steuergerät ASTM V4	900001506499	-	900001506001
335360300113	Steuergerät 5C028	900001506578	-	
335364300107/113	Steuergerät 22p 506633	900001506633	900001506397	900001506001
335383300107/113	Steuergerät ASTM V4	900001506499	900001506424	900001506439
335393300113	Steuergerät 5C028	900001506578	-	900001506439
335394300113	Steuergerät ASTM V4	900001506499	-	900001506439
335397300113	Steuergerät 22p 506633	900001506633	-	900001506439
335398300113	Steuergerät 5C033	900001506578	-	900001506439
335411300107/113	Steuergerät ASTM V4	900001506499	900001506397	900001506001
335413300107/113	Steuergerät ASTM V4	900001506499	900001506424	900001506439
335419300107/113	Steuergerät ASTM V4	900001506499	900001506424	900001506439
335423300107/113	Steuergerät ASTM V4	900001506499	900001506397	900001506001
335455300113	Steuergerät ASTM V4	900001506499	900001506397	900001506439
335456300113	Steuergerät	900001507131	-	900001506439
335494300113	Steuergerät 14p 321059	900001506848	-	-
335494300113	Steuergerät Blinkerüberwachung	900001507075	-	-
335600300113	Steuergerät 12p ASTM 10	900001506542	-	900001506617
338110300107/113	Steuergerät ASTM LC	900001506633	-	900001506001
338145300107/113	Steuergerät ASTM LC	900001506633	900001506548	900001506439
338680300113	Steuergerät 12p ALM12/1/ASTM12/ASG2000-121	900001506005	-	900001506438

Zuordnung Steuergeräte und Steckdosen

Elektrosatz	Identifikationsnummer	Ersatz-Blinkgeber	Steckdose	
			7-polig	13-polig
Bestell-Nr.		Bestell-Nr.	Bestell-Nr.	Bestell-Nr.
340072300113	Steuergerät 10p TLM C2+54	900001506639	-	900001506680
340075300113	Steuergerät 10p CCM	900001506079	900001506054	900001506386
340093300113	Steuergerät ASTM LC	900001506633	-	900001506439
340099300113	Steuergerät ASTM LC	900001506633	-	900001506001
340136300113	Steuergerät 9509	900001507091	-	900001506680
340144300113	UCC2.0 HS MITSUBISHI 01 (301365)	900001508164		900001506680
341016300113	Steuergerät 5C022	nur kpl. mit E-Satz	-	900001506680
341024300107/113	Steuergerät 12p ASTM 10	900001506542	-	900001506439
341049300107/113	Steuergerät ASTM LC	900001506633	900001506548	900001506439
341052300113	Steuergerät ASTM pro V4	900001508153	-	900001506439
341055300107/113	Steuergerät ASTM LC	900001506633	900001506424	900001506439
341059300113	Steuergerät ASTM LC	900001506633	-	900001506439
342033300107/113	Steuergerät ASTM LC	900001506633	-	900001506439
342041300107/113	Blinkgeber 4p Westfalia	900001507786	900001506424	900001506680
342097300113	Steuergerät 5C033 (alt 5C028)	900001506578	-	900001506439
342099300107/113	Steuergerät 12p ASTM 10	900001506542	900001506054	900001506387
342103300113	Steuergerät 5C033 (alt 5C028)	900001506578	-	900001506387
342105300113	506633	900001506633	-	900001506439
342184300113	Steuergerät 5C033 (alt 5C028)	900001506578	-	900001506680
342190300113	Steuergerät ASTM LC	900001506633	-	900001506439
342197300113	Steuergerät ASTM V4	900001506499	900001506397	900001506001
342200300113	Steuergerät ASTM LC	900001506633	-	900001506001
342239300113	nicht erforderlich	-	-	900001506680
342265300113	UCC2.0 HS FCA	900001507189	-	900001506124
343037300113	Steuergerät 12p ASTM 10	900001506542	-	900001506439
343056300107/113	Steuergerät ASTM LC	900001506633	900001506424	900001506439
343060300113	Steuergerät 12p ASTM 10	900001506542	-	900001506439
343063300113	Steuergerät 5D033 (alt 5C028,5C033)	900001506578	-	900001506387
343066300113	Steuergerät ASTM LC	900001506633	-	900001506124
343067300113	Flash Control - (2+1)*21 W	900001506744	-	900001506387
343069300113	Steuergerät UCC-1 MA/FO	900001506670	-	900001506439
343071300107/113	Steuergerät 5D033 (alt 5C028,5C033)	900001506578	-	900001506001
343074300113	Steuergerät ASTM LC	900001506633	-	900001506439
343076300113	Steuergerät 14p 321059	900001506848	-	-

Zuordnung Steuergeräte und Steckdosen

Elektrosatz	Identifikationsnummer	Ersatz-Blinkgeber	Steckdose	
			7-polig	13-polig
Bestell-Nr.		Bestell-Nr.	Bestell-Nr.	Bestell-Nr.
343076300113	Steuergerät Blinkerüberwachung	900001507075	-	-
343099300107/113	UCC2.0 HS Mazda CX	900001508152	900001506424	900001506680
343105300113	Steuergerät Blinkerüberwachung	900001507075	-	900001506680
343117300113			-	900001506680
343400300107/113	Steuergerät ASTM LC	900001506633	900001506424	900001506439
343660300113	Steuergerät 12p ASTM 10	900001506542	-	900001506386
343199300113	MFX ECS5F008 SW0411	900001500411	-	auf Anfrage
344023300107/113	Steuergerät 12p ALM12/1/ASTM12/ASG2000-121	900001506005	900001506397	900001506001
344027300107/113	Steuergerät 12p ALM12/1/ASTM12/ASG2000-121	900001506005	900001506424	900001506680
344040300107/113	ohne Steuergerät	-	900001506424	900001506680
344041300107/113	ohne Steuergerät	-	900001506424	900001506680
344044300107/113	Steuergerät AAG 506328, 506758	900001506758	900001506424	900001506617
344095300113	-	-	-	900001506607
344110300113	Steuergerät AAG2 300001507012	900001507012	-	900001506607
344110300113	507012	900001507012	-	900001506607
344111300137/143	Steuergerät AAG 2. Gen. 6C0.907.383.F	-	900001506054	900001506607
344250300107/113	Steuergerät 506558, 506758	900001506758	900001506397	900001506617
344500300107/113	Steuergerät AAG 506328, 506758	900001506758	900001506424	900001506439
344503300107/113	Blinkgeber 3p+2p C2 506811	900001506811	900001506424	900001506680
344504300107/113	Blinkgeber 3p+2p C2 506811	900001506811	900001506424	900001506680
345028300113	Steuergerät ASTM LC	900001506633	-	900001506439
345059300107/113	Steuergerät ASTM LC	900001506633	900001506055	900001506387
345066300113	Steuergerät ASTM LC	900001506633	-	900001506439
345068300113	Steuergerät ASTM LC	900001506633	-	900001506439
345069300113	Steuergerät ASTM LC	900001506633	-	900001506001
345070300113	TLM C2-FOG-REV-PDC (+)	900001506723	-	900001506680
345079300113	Steuergerät ASTM LC	900001506633	-	900001506439
345080300113	Steuergerät ASTM LC	900001506633	-	900001506439
345082300113	Steuergerät ASTM LC	900001506633	-	900001506439
345084300107/113	Steuergerät ASTM LC	900001506633	900001506397	900001506001
345086300107/113	Steuergerät ASTM LC	900001506633	-	900001506001
345086300107/113	Steuergerät ASTM LC	900001506633	900001506424	900001506439
345096300107/113	Steuergerät ASTM LC	900001506633	-	900001506001
345134300107/113	UCC2.0 HS Kia	900001508156	900001506424	900001506439

Zuordnung Steuergeräte und Steckdosen

Elektrosatz	Identifikationsnummer	Ersatz-Blinkgeber	Steckdose	
			7-polig	13-polig
Bestell-Nr.		Bestell-Nr.	Bestell-Nr.	Bestell-Nr.
345143300107/113	Steuergerät ASTM LC	900001506633	-	900001506001
345155300113	Steuergerät 24p., 507130	900001507130	-	900001506439
345168300113	Steuergerät ASTM LC	900001506633	-	900001506439
345169300113	Steuergerät ASTM LC	900001506633	-	900001506439
345171300107/113	Steuergerät ASTM LC	900001506633	900001506424	900001506439
345172300107/113	Steuergerät ASTM LC	900001506633	900001506424	900001506439
345173300113	Steuergerät 22p ASTM LC	900001506633	-	900001506439
345174300113	UCC2.0 HS Kia 01	900001508162	900001506424	900001506680
345220300107	Steuergerät 12p 506005	900001506005	900001506054	
345480300113	Steuergerät 12p ASTM 10	900001506542	-	900001506438
345481300113	Steuergerät 14p., 321059	900001506848	-	900001506680
345760300113	Steuergerät 12p ALM12/1/ASTM12/ASG2000-121	900001506005	-	900001506387
345880300113	Steuergerät 12p ALM12/1/ASTM12/ASG2000-121	900001506005	-	900001506124
345881300113	Steuergerät 12p ALM12/1/ASTM12/ASG2000-121	900001506005	-	900001506124
346018300107/113	Steuergerät 12p ASTM 10	900001506542	900001506424	900001506439
346049300107/113	Steuergerät ASTM LC	900001506633	900001506548	900001506439
346057300113	Steuergerät 5C022	nur kpl. mit E-Satz	-	900001506680
346059300113	Blinkgeber 3p+2p C2 506811	900001506811	-	900001506439
346064300107/113	Steuergerät ASTM LC	900001506633	900001506424	900001506439
346066300113	Steuergerät 12p ASTM 10	900001506542	-	900001506439
346071300113	Steuergerät ASTM LC	900001506633	-	900001506439
346076300107/113	Steuergerät ASTM LC	900001506633	-	900001506439
346142300107/113	Steuergerät ASTM LC	900001506633	900001506548	900001506439
346143300107/113	Steuergerät ASTM LC	900001506633	900001506548	900001506439
346145300113	Steuergerät ASTM LC	900001506633	-	900001506439
346146300107/113	Steuergerät 22p ASTM LC	900001506633	900001506424	900001506439
346800300107/113	Steuergerät 12p ASTM 10	900001506542	900001506424	900001506439
346810300107/113	Steuergerät 12p ASTM 10	900001506542	900001506424	900001506439
348020300113	Flash Control - (2+1)*21 W	900001507786	-	
348023300113	Flash Control - (2+1)*21 W	900001507786	-	
348026300113	Flash Control - (2+1)*21 W	900001507786	-	
348037300113	Steuergerät ASTM LC	900001506633	-	900001506439
348054300113	Steuergerät 14p., 321059	900001506848	-	900001506439
348055300113	Steuergerät 14p., 321059	900001506848	-	900001506439

Zuordnung Steuergeräte und Steckdosen

Elektrosatz	Identifikationsnummer	Ersatz-Blinkgeber	Steckdose	
			7-polig	13-polig
Bestell-Nr.		Bestell-Nr.	Bestell-Nr.	Bestell-Nr.
348062300113	Steuergerät 14p 321059	900001506848	-	
348073300113	Steuergerät 22p ASTM LC	900001506633	-	900001507018
349025300113	Steuergerät	900001506691	-	900001506439
349039300107/113	Steuergerät ASTM LC	900001506633	900001506054	900001506386
349049300113	Steuergerät ASTM LC	900001506633	-	900001506439
349053300113	Steuergerät ASTM LC	900001506633	900001506424	900001506439
351008300113		auf Anfrage	-	auf Anfrage
351009300113	Steuergerät ASTM LC	900001506633	-	auf Anfrage

Adapter and plugs



Adapter, short 7/13

from car 7-pins to trailer 13-pins

order no.: 300 100 310 107



Adapter, short 13/7

from car 13-pins to trailer 7-pins

order no.: 300 100 320 113



Plug 13p

order no.: 900 001 506 533



Adapter 13p West

from car 13-pins (DIN/ISO 11446) to trailer 7-/13-pins West

order no.: 900 001 506 997

Sockets and seals



Socket 13-pins

Screw connection (option for cable outlet in the side w. seal 900 001 507 001)
cable outlet on side, with rear fog light disconnecting contact

order no.: 900 001 506 001



Socket 13-pins

Contact sockets with solder connections, double microswitch, axial cable outlet

order no.: 900 001 506 037



Socket 7-pins

Screw connection, microswitch changer, axial cable outlet (N-version DIN/ISO 1724)

order no.: 900 001 506 054



Socket 13-pins

Flat version 40 mm high, crimp contact, microswitch, cable outlet on right side

order no.: 900 001 506 124



Socket 13-pins

West plug system
Screw connection without rear fog light disconnecting contact, axial cable outlet
similar to (N-Version DIN/ISO 1724) + 6 contacts

order no.: 900 001 506 210



Socket 7-pins

Crimp connection, without rear fog light disconnecting contact, axial cable outlet (N-version DIN/ISO 1724)

order no.: 900 001 506 384



Socket 13-pins

Screw connection, microswitch
cable outlet on side

order no.: 900 001 506 386

Sockets and seals



Socket 13-pins

Screw connection, microswitch
axial cable outlet

order no.: 900 001 506 387



Socket 7-pins

Screw connection, rear fog light disconnecting contact,
cable outlet on right side
(N-version DIN/ISO 1724)

order no.: 900 001 506 397



Socket 7-pins

Screw connection, rear fog light disconnecting contact, axial
cable outlet
(N-version DIN/ISO 1724)

order no.: 900 001 506 424



Socket 13-pins

Screw connection (option for cable outlet in the side w. seal
900 001 507 001)
axial cable outlet, without rear fog light disconnecting
contact

order no.: 900 001 506 439



Socket 7-pins

7p. Extension socket for English vehicle market
(S-version DIN/ISO 3732)

order no.: 900 001 506 656



Socket 13-pins

Screw connection (option for cable outlet in the side w. seal
900 001 507 001)
axial cable outlet, with rear fog light disconnecting contact

order no.: 900 001 506 680

Accessories for sockets



Screw connection with bellows, cable outlet on right side

package 10 pieces: order no. 900 010 503 924

order no.: 900 001 503 924



Socket seal, 2 axial cable outlets

order no.: 900 001 506 010



Socket seal with bellows, axial cable outlet

package 10 pieces: order no. 900 010 506 024

order no.: 900 001 506 024



Substitute socket housing 52 mm high, axial cable outlet

order no.: 900 001 506 438



Seal for 900 001 506 439/680/001/, outlet on right side, 2 pieces

package 10 pieces: order no. 900 010 507 001

order no.: 900 001 507 001



Additional socket plate for 2nd socket

(GB market)

order no.: 900 001 535 208



Cable support sleeve angled, for 40 mm car body openings, cable diameter: 6 - 14 mm

(package 10 pieces)

order no.: 900 010 303 015

Accessories for sockets



Socket seal, axial cable outlet
(package 10 pieces)

order no.: 900 010 506 531



Socket base plate for slit holders
(package 10 pieces)

order no.: 900 010 506 616



Spare part kit folding plastic socket holder
with slot

order no.: 907 292 608 001



**Substitute socket holder with slash,
universal**
package 10 pieces: order no. 920 036 608 110

order no.: 920 036 608 001



Substitute socket holder, universal

order no.: 900 001 005 347



Spare part kit folding plastic socket holder
without slot

order no.: 921 504 608 001



Spare part kit folding plastic socket holder
without slot

order no.: =>P J=J A>D >>?

Accessories for wiring kits



Vehicle tester trailer simulation 12 V, for function control and fault simulation

order no.: 900 001 300 198



Signal generator

6 - 24 Volt

order no.: 900 001 300 200



C2 light compl. 12 V (short version)

long version: order no. 900 001 507 809

order no.: 900 001 506 547



Cable connector for cable diameter 0.35-0.75 m²

(package 4 pieces)

order no.: 900 001 506 102



Cable connector

for cable diameter 1.0-2.5 m²

order no.: 900 010 507 391



Relay adapter

(for adapting various different relay assignments)

order no.: 900 061 305 001



C2 cable bridge for older Vauxhall vehicles

order no.: 914 083 303 020

Cycle carrier
BC 60 / BC 70 /
bikelander

Accessories

Spare parts

Load Carrier System BC 60



Bicycle carrier bikelander

with hybride LED lights

- Measurements (W/H/D): 580x220x690 mm (hinged) / 686x1250x678 mm (expanded) -
- Weight: 17,5 kg
- Max. payload: 60,0 kg
- Wheelbase: up to 1300 mm
- Bicycle frame: up to 80 mm diameter
- Section width: up to 70 mm

order no.: 350 050 600 001



Bicycle carrier bikelander classic

with conventional lights

- Measurements (W/H/D): 580x220x690 mm (hinged) / 686x1265x678 mm (expanded) -
- Weight: 17,5 kg
- Max. payload: 60,0 kg
- Wheelbase: up to 1300 mm
- Bicycle frame: up to 80 mm diameter
- Section width: up to 70 mm

order no.: 350 053 600 001



Bicycle carrier bikelander 3 bikes

with hybride LED lights

- Measurements (W/H/D): 580x220x810 mm (hinged) / 686x1250x678 mm (expanded)
- Weight: 20,5 kg
- Max. payload: 60,0 kg
- Wheelbase: up to 1300 mm
- Bicycle frame: up to 80 mm diameter
- Section width: up to 70 mm

order no. 350 050 600 001



Box (for BC 60, BC 70 & bikelander/classic)

Measurements (W/H/D): 1170 x 600 x 425 mm

Weight: 15,0 kg

Max. payload: 45,0 kg

Capacity: 200 l

Colour: anthracite

order no.: 350 002 600 001



Platform (for BC 60, BC 70 & bikelander/classic)

Measurements (W/H/D): 1290 x 230 x 413 mm

Weight: 6,0 kg

Max. payload: 54,0 kg

Colour: anthracite

order no.: 350 004 600 001



Expansion rail for the 3rd bicycle

Exc. bikelander 3 bikes

Max. payload: 20 kg

Weight 5,5 kg

Wheelbase: up to 1300 mm

order no.: 350 014 600 001

Load Carrier System BC 60



Bag

For clean storage of the cycle carrier

bag for 2 bike racks

order no.: 350 013 600 001

bag for 2 bike racks

order no.: 350 017 600 001



Drive up ramp (for easy loading of heavy cycles) (for BC 60, BC 70 & bikelander/classic)

for models Portilo (year of construction: -12/11: order no. 350 009 600 001

order no.: 350 020 600 001



Wall mounting bracket (for BC 60, BC 70 & bikelander/classic)

Steel construction for easy storage of the BC 60 cycles carrier to any wall

order no.: 350 006 600 001



Additional brake light (for BC 60, BC 70 & bikelander/classic)

Legal requirement if the bikes obscure the 3rd brake light of the vehicle

order no.: 350 000 305 173



Gear belt extension (for BC 60, BC 70 & bikelander/classic)

order no.: 950 000 622 00 (2 pcs.)



Heat protection

order no.: 350 005 600 001



Presentation rack cycle carrier (for BC 60, BC 70 & bikelander/classic)

(cycle carrier is not included)

order no.: 950 003 631 001

Load Carrier Spare Parts



Lamp (for BC 60, BC 70 & bikelander classic)
left (without wire)

order no.: 950 000 302 003



Lamp (for BC 60, BC 70 & bikelander classic)
right (without cable)

order no.: 950 000 302 004



Lamp (for bikelander)
left (without wire)

order no.: 950 050 306 001



Lamp (for bikelander)
right (without cable)

order no.: 950 050 306 002



Lamp left + right (for bikelander)
inc. wire

order no.: 950 050 302 001



cover for lamp left (for bikelander)

order no.: 950 050 302 003



cover for lamp right (for bikelander)

order no.: 950 050 302 004

Load Carrier Spare Parts



Light cluster arm left (for BC 60, BC 70 & bikelander classic)

order no.: 950 000 631 001



Light cluster arm right (for BC 60, BC 70 & bikelander classic)

order no.: 950 000 631 002



Light cluster arm left (for bikelander)

order no.: 950 050 631 001



Light cluster arm right (for bikelander)

order no.: 950 050 631 002



holder for licence plate (for bikelander/classic)

order no.: 950 050 631 003



clamp for licence plate (for bikelander/classic)
2 pieces

order no.: 950 050 631 004



clamp for wire (for bikelander/classic)
6 pieces

order no.: 950 050 642 001

Load Carrier Spare Parts



Bracket / bow (for bikelander/classic)

order no.: 950 050 613 001



Receiver for bracket (for BC 60, BC 70 & bikelander/classic)

inc. 2 x cog wheel
(discontinued model)

order no.: 950 000 621 001



Star grip incl. round head screw (for BC 60, BC 70 & bikelander/classic)

order no.: 950 000 637 001



Claw short incl. key / lock (for BC 60 & BC 70)

inc. keys

order no.: 950 000 633 001



Claw long incl. key / lock (for BC 60 & BC 70)

inc. keys

order no.: 950 035 633 002



Claw short incl. key / lock (for bikelander/classic)

order no.: 950 050 633 006



Claw long incl. key / lock (for bikelander/classic)

order no.: 950 050 633 007

Load Carrier Spare Parts



Claw for 3rd bicycle incl. key / lock

order no.: 950 001 633 004



knob for claw (2 pieces) (2 stk) (for BC 70 & bikelander/classic)

incl. 3 keys
(for version BC 60: part.-no. 950 000 633 003)

order no.: 950 035 633 003



Wing left (for BC70 & bikelander/classic)

(for models Portilo (year of construction: -12/11: order no. 950 000 619 001))

order no.: 950 050 619 002



Wing right (for BC 70 & bikelander/classic)

(for models Portilo (year of construction: -12/11: order no. 950 000 619 001))

order no.: 950 050 619 003



Spring set for wheel support

4 pieces

order no.: 950 050 626 001



Locking mechanism for wings (for BC 60, BC 70 & bikelander/classic)

4 pieces

order no.: 950 010 627 001



Gear belt incl. Clothing (ratchet belt) (for BC 70 & bikelander/classic)

(for models Portilo (year of construction: -12/11: order no. 950 000 622 001))

(for models BC 60: order no. 950 010 622 001)

order no.: 950 035 622 001

Load Carrier Spare Parts



**rim protector (for BC 60, BC 70 & bikelander/
classic)**
4 pieces

order no.: 950 030 622 001



Key (for BC 60, BC 70 & bikelander/classic)
2 pieces
(xx = key number)

order no.: 950 000 513 3xx



Key (for box & platform)
2 pieces
(xx = key number)

order no.: 950 000 513 1xx



Replacement locks for transport box
(package 2 pieces)

order no.: 950 002 513 300



Replacement lock for transport platform

order no.: 950 004 513 300

Autocode

Autocode



Autocode

Coding tool
- for coding the vehicle for trailer use
- inc. unlimited number of releases in the first year of the subscription

order no.: 900 001 400 199



Autocode-Mini

Coding tool
- for coding the vehicle for trailer use
- no subscription necessary: You can buy only one code or if you want 5 or 10 codes for a preferential price

order no.: 900 001 400 202

Voucher Code Autocode-Mini for 1 Coding

order no.: 900 001 400 203

Voucher Code Autocode-Mini for 5 Codings

order no.: 900 001 400 204

Voucher Code Autocode-Mini for 10 Codings

order no.: 900 001 400 205

Annual subscription

order no.: 900 001 400 208



Autocode-Remote

Coding tool
- for coding the vehicle for trailer use
- no subscription necessary

order no.: 900 001 400 209

Power Springs

Program overview power spings

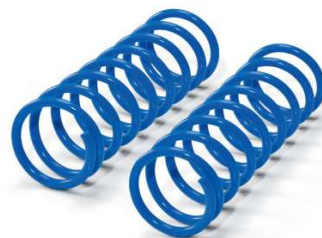

Edition: 11/2023

Brand	Model	Year of construction	Item no.	Weight (kg)	Installation time (min)	Description	R = Additional- R = Replacement-Spring	Heav Duty for permanent loaded vehicles
Audi	A3 Convertible (8V7,8VE)	10/2013-10/2020	405403500001	1,5	45	inc. 4WD and e-tron exc. vehicles with level control exc. S-Line landing gear and S3	A	
Audi	A3 Convertible (8V7, 8VE)	10/2013-10/2020	421676500001	2	45	inc. 4WD and e-tron exc. vehicles with level control exc. S-Line landing gear and S3	A	HD
Audi	A3 Hatchback (8P1)	05/2003-08/2012	421600500001	1,3	30	inc. 4 WD exc. vehicles with level control	A	
Audi	A3 Saloon (8VS, 8VM)	05/2013-10/2020	405403500001	1,5	45	exc. S-Line landing gear, S3 and RS3 inc. 4WD and e-tron exc. vehicles with level control	A	
Audi	A3 Saloon (8VS, 8VM)	05/2013-10/2020	421676500001	2	45	inc. 4WD and e-tron exc. vehicles with level control exc. S-Line landing gear, S3 and RS3	A	HD
Audi	A3 Saloon (8YS)	04/2020-	405403500001	1,5	45	inc. 4WD and e-tron exc. vehicles with level control exc. S-Line landing gear, S3 and RS3	A	
Audi	A3 Saloon (8YS)	04/2020-	421676500001	2	45	inc. 4WD and e-tron exc. vehicles with level control exc. S-Line landing gear, S3 and RS3	A	HD
Audi	A3 Sportback (8PA)	05/2003-03/2013	421600500001	1,3	30	inc. 4 WD exc. vehicles with level control	A	
Audi	A3 Sportback (8VA, 8VF)	09/2012-10/2020	405403500001	1,5	45	inc. 4WD and e-tron exc. vehicles with level control exc. S-Line landing gear, S3 and RS3	A	

Brand	Model	Year of construction	Item no.	Weight (kg)	Installation time (min)	Description	R = Additional- R = Replacement-Spring	Heav Duty for permanent loaded vehicles
Audi	A3 Sportback (8VA, 8VF)	09/2012-10/2020	421676500001	2	45	inc. 4WD and e-tron exc. vehicles with level control exc. S-Line landing gear, S3 and RS3	A	HD
Audi	A3 Sportback (8YA)	11/2019-	405403500001	1,5	45	inc. 4WD and e-tron exc. vehicles with level control exc. S-Line landing gear, S3 and RS3	A	
Audi	A3 Sportback (8YA)	11/2019-	421676500001	2	45	inc. 4WD and e-tron exc. vehicles with level control exc. S-Line landing gear, S3 and RS3	A	HD
Audi	A3 (8V1, 8VK)	04/2012-10/2020	405403500001	1,5	45	inc. 4WD and e-tron exc. vehicles with level control exc. S-Line landing gear, S3 and RS3	A	
Audi	A3 (8V1, 8VK)	04/2012-10/2020	421676500001	2	45	inc. 4WD and e-tron exc. vehicles with level control exc. S-Line landing gear, S3 and RS3	A	HD
Audi	A4 B8 Avant (8K5)	11/2007-12/2015	405425500001	1,5	30	exc. vehicles with level control inc. 4 WD exc. S-Line landing gear, S4 and RS4	A	
Audi	A4 B8 Saloon (8K2)	11/2007-12/2015	405425500001	1,5	30	exc. vehicles with level control inc. 4 WD exc. S-Line landing gear, S4 and RS4	A	
Audi	A5 B8 (8T3)	06/2007-01/2017	405425500001	1,5	30	exc. vehicles with level control inc. 4 WD exc. S-Line landing gear, S5 and RS5	A	
Audi	A6 C7 Avant (4G5, 4GD)	05/2011-09/2018	405425500001	1,5	30	exc. vehicles with level control inc. 4 WD exc. S-Line landing gear, S6 and RS6	A	
Audi	A6 C7 Saloon (4G2, 4GC)	11/2010-09/2018	405425500001	1,5	30	exc. vehicles with level control inc. 4 WD exc. S-Line landing gear, S6 and RS6	A	
Audi	Q2 (GAB, GAG)	06/2016-	421676500001	2	45	inc. 4 WD exc. vehicles with level control exc. S-Line landing gear and SQ2	A	HD

Brand	Model	Year of construction	Item no.	Weight (kg)	Installation time (min)	Description	R = Additional- R = Replacement-Spring	Heav Duty for permanent loaded vehicles
Audi	Q2 (GAB,GAG)	06/2016-	405403500001	1,5	45	inc. 4 WD exc. vehicles with level control exc. S-Line landing gear and SQ2	A	
Audi	Q3 Sportback (F3N)	09/2019-	405403500001	1,5	45	inc. 4 WD exc. vehicles with level control exc. S-Line landing gear, SQ3 and RSQ3	A	
Audi	Q3 Sportback (F3N)	09/2019-	421676500001	2	45	inc. 4 WD exc. vehicles with level control exc. S-Line landing gear, SQ3 and RSQ3	A	HD
Audi	Q3 (8UB, 8UG)	06/2011-10/2018	421600500001	1,3	45	inc. 4 WD exc. vehicles with level control exc. S-Line landing gear and RSQ3	A	
Audi	Q3 (F3B)	08/2018-	405403500001	1,5	45	inc. 4 WD exc. vehicles with level control exc. S-Line landing gear, SQ3 and RSQ3	A	
Audi	Q3 (F3B)	08/2018-	421676500001	2	45	inc. 4 WD exc. vehicles with level control exc. S-Line landing gear, SQ3 and RSQ3	A	HD
Audi	Q5 (8RB)	11/2008-05/2017	405425500001	1,5	30	inc. 4 WD und Hybrid exc. vehicles with level control exc. S-Line landing gear and SQ5	A	
Citroën	Berlingo L1 (B9)	04/2008-08/2018	404092500001	6,7	30	for vehicles with SWB (short wheelbase) exc. Multipass	R	
Citroën	Berlingo L2 (B9)	04/2008-08/2018	404131500001	7,1	30	inc. facelift from year of construction 08/2016- for vehicles with LWB (long wheelbase)	R	

Brand	Model	Year of construction	Item no.	Weight (kg)	Installation time (min)	Description	R = Additional- R = Replacement-Spring	Heav Duty for permanent loaded vehicles
Citroën	Berlingo M & XL (K9)	03/2018-	404131500001	7,1	30	for vehicles with white PUR end stops only for front-wheel drive vehicles not for vehicles with standard lift kit, air suspension, load-dependent brake pressure regulator on axle 2 and level control	R	HD
Citroën	Berlingo M (K9)	06/2018-	404092500001	6,7	30	for vehicles with white PUR end stops only for front-wheel drive vehicles not for vehicles with standard lift kit, air suspension, load-dependent brake pressure regulator on axle 2 and level control	R	
Citroën	Berlingo Multispace (B9)	04/2008-08/2018	404335500001	7	30	exc. vehicles with 4 WD and XTR	A	
Citroën	C4 Grand Picasso II (DA, DE)	09/2013-03/2018	404151500001	1,9	45	exc. hybrid and vehicles with level control	A	
Citroën	C4 Grand SpaceTourer (3A, 3E)	04/2018-	404151500001	1,9	45	not for vehicles with air suspension, load-dependent brake pressure regulator on axis 2 and level control	A	
Citroën	C4 Picasso II	02/2013-03/2018	404151500001	1,9	45	exc. hybrid and vehicles with level control	A	
Citroën	C4 Picasso (UD)	10/2006-08/2013	404092500001	6,7	30	not for vehicles with air suspension	R	
Citroën	C4 SpaceTourer (3D)	04/2018-	404151500001	1,9	45	not for vehicles with air suspension, load-dependent brake pressure regulator on axis 2 and level control	A	

Brand	Model	Year of construction	Item no.	Weight (kg)	Installation time (min)	Description	R = Additional- R = Replacement-Spring	Heav Duty for permanent loaded vehicles
Citroën	Jumper II (250)	04/2006-	406374500001	8,4	45	inc. e-Jumper (electric and hybrid) only for vehicles with unladen axle loads of 1,100 kg or more the minimum load is 350 kg, not for AL-KO rear axle, vehicles with level control, standard air suspension and load-dependent brake pressure regulator on axis 2	A	HD
Citroën	Jumper II (250)	04/2006-	404271500001	3,8	45	inc. e-Jumper (electric and hybrid) only for vehicles with single leaf springs not for vehicles with load-dependent brake pressure regulators	A	
Citroën	Jumpy II Bus/Van (VF7)	01/2007-03/2016	404333500001	2,5	45	exc. vehicles with level control	A	
Cupra	Formentor (KM7)	07/2020-	405403500001	1,5	45	inc. 4 WD exc. vehicles with level control	A	
Cupra	Formentor (KM7)	07/2020-	421676500001	2	45	inc. 4 WD exc. vehicles with level control	A	HD
Fiat	Doblo II Cargo (263)	02/2010-06/2022	406368500001	2,3	45	exc. Estate	A	
Fiat	Doblo II Estate (263)	11/2009-06/2022	406369500001	1,6	45	exc. Van and Platform	A	
Fiat	Doblo II Platform (263)	02/2010-	406368500001	2,3	45		A	
Fiat	Ducato (250)	07/2006-	404271500001	3,8	45	inc. E-Ducato (electric and hybrid) only for vehicles with single leaf springs not for vehicles with load-dependent brake pressure regulators	A	

Brand	Model	Year of construction	Item no.	Weight (kg)	Installation time (min)	Description	R = Additional- R = Replacement-Spring	Heav Duty for permanent loaded vehicles
Fiat	Ducato (250)	07/2006-	406374500001	8,4	45	only for vehicles with ABS and curb weight axle loads from 1,100 kg inc. E-Ducato (electric and hybrid) the minimum load is 350 kg not for AL-KO rear axle, vehicles with level control, standard air suspension and load-dependent brake pressure regulator on axle 2	A	HD
Fiat	Scudo (270, 272)	01/2007-03/2016	404333500001	2,5	45	exc. vehicles with level control	A	
Fiat	Talento (296)	06/2016-	414364500001	2,3	45		A	
Fiat	Talento (296)	06/2016-	414870500001	10,2	30		R	HD
Ford	Mondeo V Hatchback (CE)	02/2015-	407527500001	1,2	30	inc. hybrid	A	
Ford	Mondeo V Hatchback (CD)	02/2015-	407527500001	1,2	30	inc. hybrid	A	
Ford	Mondeo V Turnier (CF)	02/2015-	407527500001	1,2	30	inc. hybrid	A	
Ford	Transit Connect II (V408)	02/2013-09/2018	407526500001	11,1	30	for L1 & L2 Heavy Duty kit for L1	R	HD
Ford	Tourneo Connect III	02/2022-	421678500001	7	30	exc. vehicles with lowered suspension, air suspension, load-dependent brake pressure regulator on axle 2 and level control	R	
Ford	Transit Connect III	05/2022-	421678500001	7	30	exc. vehicles with lowered suspension, air suspension, load-dependent brake pressure regulator on axle 2 and level control	R	

Brand	Model	Year of construction	Item no.	Weight (kg)	Installation time (min)	Description	R = Additional- R = Replacement-Spring	Heav Duty for permanent loaded vehicles
Ford	Transit VII V363 Bus/Van (FAD, FBD, FCD, FDD)	08/2013-	407530500001	9	30	only for vehicles with front wheel drive	A	
Ford	Transit VII V363 Platform (FED, FFD)	08/2013-	407530500001	9	30	only for vehicles with front wheel drive	A	
Hyundai	I30 CW (FD)	10/2007-06/2012	446075500001	5,3	60	exc. vehicles with level control	R	
Hyundai	I30 CW (GD)	06/2012-06/2017	446075500001	5,3	60	exc. vehicles with level control	R	
Hyundai	iX35 (LM, EL, ELH)	08/2009-09/2015	446075500001	5,3	60	only for vehicles with front wheel drive exc. vehicles with level control	R	
Hyundai	Tucson (TL, TLE)	06/2015-09/2020	446073500001	4,6	45	inc. 4 WD exc. vehicles with level control	A	
Kia	Cee'd SW (ED)	07/2007-12/2012	446075500001	5,3	60	exc. vehicles with load-dependent brake pressure regulators and level control	R	
Kia	Cee'd SW (JD)	09/2012-07/2018	446075500001	5,3	60	exc. vehicles with load-dependent brake pressure regulators and level control	R	
Kia	Sportage III (SL)	06/2010-02/2016	446075500001	5,3	60	exc. vehicles with load-dependent brake pressure regulators and level control	R	
Kia	Sportage IV (QL, QLE)	09/2015-09/2022	446073500001	4,6	45	inc. 4 WD exc. vehicles with level control	A	
Mercedes Benz	Citan Van (W415)	11/2012-08/2021	413432500001	1,6	45	exc. vehicles with level control	A	
Mercedes Benz	Citan Tourer (W415)	11/2012-08/2021	413432500001	1,6	45	exc. vehicles with level control	A	
Mercedes Benz	EQV (W447)	06/2020-	413435500001	11,2	30	exc. vehicles with level control and lift kit	R	
Mercedes Benz	EQV (W447)	06/2020-	413436500001	11,2	30	the minimum load must always be 150 kg exc. vehicles with level control and lift	R	HD

Brand	Model	Year of construction	Item no.	Weight (kg)	Installation time (min)	Description	R = Additional- R = Replacement-Spring	Heav Duty for permanent loaded vehicles
Mercedes Benz	Sprinter (906)	06/2006-01/2018	413376500001	10,9	60	only for vehicles with single tires inc. vehicles with original lowering exc. 4 WD	A	
Mercedes Benz	Sprinter (907)	02/2018-	413376500001	10,9	45	only for vehicles with rear-wheel drive and single tires exc. vehicles with standard air suspension, CE8 elevated vehicles, load-dependent brake pressure regulator and level control	A	
Mercedes Benz	Viano (W639)	09/2003-10/2014	413382500001	2,7	45	only for vehicles with ABS exc. vehicles with level control	A	
Mercedes Benz	Vito (W639)	09/2003-10/2014	413382500001	2,7	45	only for vehicles with ABS exc. vehicles with level control	A	
Mercedes Benz	Vito (W447)	03/2014-	413435500001	11,2	30	inc. 4Matic and eVito exc. vehicles with level control and lift kit	R	
Mercedes Benz	Vito Tourer (W447)	03/2014-	413435500001	11,2	30	inc. 4Matic and eVito exc. vehicles with level control and lift kit	R	
Mercedes Benz	Vito Tourer (W447)	03/2014-	413436500001	11,2	30	the minimum load must always be 150 kg inc. 4Matic and eVito exc. vehicles with level control and lift kit	R	HD
Mercedes Benz	Vito (W447)	03/2014-	413436500001	11,2	30	the minimum load must always be 150 kg inc. 4Matic and eVito exc. vehicles with level control and lift kit	R	HD
Mercedes Benz	V-class (W447)	03/2014-	413435500001	11,2	30	inc. 4Matic exc. vehicles with level control and lift kit	R	

Brand	Model	Year of construction	Item no.	Weight (kg)	Installation time (min)	Description	R = Additional- R = Replacement-Spring	Heav Duty for permanent loaded vehicles
Mercedes Benz	V-class (W447)	03/2014-	413436500001	11,2	30	the minimum load must always be 150 kg inc. 4Matic and eVito exc. vehicles with level control and lift kit	R	HD
Nissan	NV300 (X82)	09/2016-	414364500001	2,3	45		A	
Nissan	NV300 (X82)	09/2016-	414870500001	10,2	30		R	HD
Nissan	NV400 (X62, X62B)	11/2011-	416318500001	8,1	30	only for vehicles with front-wheel drive and single leaf springs	A	
Nissan	Primastar (X83)	03/2001-08/2016	414364500001	2,3	45	only for vehicles with 16" standard tires up to a maximum of 1,650 kg rear axle load on vehicles with ALB controller	A	
Nissan	Primastar (X83)	03/2001-08/2016	414870500001	10,2	30	only for vehicles with ABS	R	HD
Opel/ Vauxhall	Combo Cargo M (K9)	06/2018-	404092500001	6,7	30	exc. Tour / Life for vehicles with white PUR end stops only for vehicles with front wheel drive exc. vehicles with standard lift kit, air suspension, load-dependent brake pressure regulator on axle 2 and level control	R	
Opel/ Vauxhall	Combo Van (X12)	02/2012-08/2018	406368500001	2,3	45	exc. Tour	A	
Opel/ Vauxhall	Combo Tour / Life M & XL (K9)	06/2018-	404131500001	7,1	30	for vehicles with white PUR end stops only for vehicles with front wheel drive exc. vehicles with standard lift kit, air suspension, load-dependent brake pressure regulator on axle 2 and level control	R	HD

Brand	Model	Year of construction	Item no.	Weight (kg)	Installation time (min)	Description	R = Additional- R = Replacement-Spring	Heav Duty for permanent loaded vehicles
Opel/ Vauxhall	Combo Tour (X12)	02/2012-08/2018	406369500001	1,6	45	exc. Van and Estate	A	
Opel/ Vauxhall	Movano B (X62)	05/2010-10/2021	416318500001	8,1	30	only for vehicles with front-wheel drive and single leaf springs	A	
Opel/ Vauxhall	Movano C (U9)	12/2021-	404271500001	3,8	45	inc. Movano-e (electric and hybrid) only for vehicles with single leaf springs exc. vehicles with load-dependent brake pressure regulators	A	
Opel/ Vauxhall	Movano C (U9)	12/2021-	406374500001	8,4	45	only for vehicles with unladen axle loads of 1,100 kg or more inc. Movano-e (electric and hybrid) the minimum load is 350 kg exc. AL-KO rear axle, vehicles with level control, standard air suspension and load-dependent brake pressure regulator on axle 2	A	HD
Opel/ Vauxhall	Vivaro A (X83)	08/2001-07/2014	414364500001	2,3	45	up to a maximum of 1,650 kg rear axle load on vehicles with ALB controller	A	
Opel/ Vauxhall	Vivaro A (X83)	08/2001-07/2014	414870500001	10,2	30	only for vehicles with ABS	R	HD
Opel/ Vauxhall	Vivaro B (X82)	06/2014-12/2019	414364500001	2,3	45		A	
Opel/ Vauxhall	Vivaro B (X82)	06/2014-12/2019	414870500001	10,2	30		R	HD
Peugeot	3008 II (M_)	05/2016-	404151500001	1,9	45	exc. hybrids and vehicles with level control	A	
Peugeot	308 II SW (L_)	09/2013-06/2021	404151500001	1,9	45		A	
Peugeot	308 II (L_)	09/2013-06/2021	404151500001	1,9	45		A	
Peugeot	5008 II (M_)	06/2017-	404151500001	1,9	45	exc. vehicles with level control	A	

Brand	Model	Year of construction	Item no.	Weight (kg)	Installation time (min)	Description	R = Additional- R = Replacement-Spring	Heav Duty for permanent loaded vehicles
Peugeot	Boxer	09/2005-	406374500001	8,4	45	inc. E-Boxer (electric and hybrid) only for vehicles with unladen axle loads of 1,100 kg or more the minimum load is 350 kg exc. AL-KO rear axle, vehicles with level control, standard air suspension and load-dependent brake pressure regulator on axle 2	A	HD
Peugeot	Boxer	09/2005-	404271500001	3,8	45	inc. E-Boxer (electric and hybrid) only for vehicles with single leaf springs exc. vehicles with load-dependent brake pressure regulators	A	
Peugeot	Expert (VF3)	01/2007-03/2016	404333500001	2,5	45	exc. vehicles with level control	A	
Peugeot	Partner Van L1	04/2008-08/2018	404092500001	6,7	30	for vehicles with SWB (short wheelbase)	R	
Peugeot	Partner Van L1 (K9)	09/2018-	404092500001	6,7	30	for vehicles with SWB (short wheelbase) for vehicles with white PUR end stops only for front-wheel drive vehicles not for vehicles with standard lift kit, air suspension, load-dependent brake pressure regulator on axle 2 and level control	R	
Peugeot	Partner L2	04/2008-08/2018	404131500001	7,1	30	for vehicles with LWB (long wheelbase)	R	
Peugeot	Partner Tepee	06/2008-	404333500001	7	30	exc. Outdoor, XTR and vehicles with level control	A	
Peugeot	Rifter L1 & L2	09/2018-	404131500001	7,1	30	for vehicles with white PUR end stops exc. vehicles with standard lift kit, air suspension, load-dependent brake pressure regulator on axle 2 and level control	R	HD

Brand	Model	Year of construction	Item no.	Weight (kg)	Installation time (min)	Description	R = Additional- R = Replacement-Spring	Heav Duty for permanent loaded vehicles
Renault	Master III (JV, FV)	02/2010-	416318500001	8,1	30	inc. Z.E. only for vehicles with front-wheel drive and single leaf springs	A	
Renault	Trafic II (JL, FL)	03/2001-04/2014	414870500001	10,2	30		R	HD
Renault	Trafic II (JL, FL)	03/2001-07/2014	414364500001	2,3	45	up to a maximum of 1,650 kg rear axle load on vehicles with ALB controller	A	
Renault	Trafic III (FG, JG)	05/2014-	414364500001	2,3	45		A	
Renault	Trafic III (JG, FG)	05/2014-	414870500001	10,2	30		R	HD
Seat	Alhambra (7N, 710, 711)	06/2010-	421600500001	1,3	30	inc. Ecomotive exc. vehicles with level control	A	
Seat	Altea XL (5P5, 5P8)	03/2004-12/2015	421600500001	1,3	30	inc. Ecomotive exc. vehicles with level control	A	
Seat	Altea (5P1)	03/2004-12/2015	421600500001	1,3	30	inc. Ecomotive exc. vehicles with level control	A	
Seat	Ateca (KH7, KHP)	04/2016-	405403500001	1,5	45	inc. 4 WD for vehicles with multilink axles exc. vehicles with level control exc. Cupra Ateca	A	
Seat	Ateca (KH7, KHP)	04/2016-	421676500001	2	45	inc. 4 WD for vehicles with multilink axles exc. vehicles with level control exc. Cupra Ateca	A	HD
Seat	Leon II (1P1)	05/2005-12/2012	421600500001	1,3	30	inc. Ecomotive exc. vehicles with level control	A	
Seat	Leon III Hatchback (5F1)	09/2012-08/2020	421676500001	2	45	inc. 4 WD exc. vehicles with air suspension, load-dependent brake pressure regulator on axis 2 and level control exc. Cupra	A	HD

Brand	Model	Year of construction	Item no.	Weight (kg)	Installation time (min)	Description	R = Additional- R = Replacement-Spring	Heav Duty for permanent loaded vehicles
Seat	Leon III Hatchback (5F1)	09/2012-08/2020	405403500001	1,5	45	inc. 4 WD exc. vehicles with air suspension, load-dependent brake pressure regulator on axis 2 and level control exc. Cupra	A	
Seat	Leon III SC (5F5)	01/2013-08/2018	405403500001	1,5	45	inc. 4 WD exc. vehicles with air suspension, load-dependent brake pressure regulator on axis 2 and level control exc. Cupra	A	
Seat	Leon III SC (5F5)	01/2013-08/2018	421676500001	2	45	inc. 4 WD exc. vehicles with air suspension, load-dependent brake pressure regulator on axis 2 and level control exc. Cupra	A	HD
Seat	Leon III Sportstourer (5F8)	09/2012-08/2020	405403500001	1,5	45	inc. 4 WD exc. vehicles with air suspension, load-dependent brake pressure regulator on axis 2 and level control exc. Cupra	A	
Seat	Leon III Sportstourer (5F8)	09/2012-08/2020	421676500001	2	45	inc. 4 WD exc. vehicles with air suspension, load-dependent brake pressure regulator on axis 2 and level control exc. Cupra	A	HD
Seat	Leon III X-Perience (5F8)	09/2012-08/2020	405403500001	1,5	45	inc. 4 WD exc. vehicles with air suspension, load-dependent brake pressure regulator on axis 2 and level control	A	
Seat	Leon III X-Perience (5F8)	09/2012-08/2020	421676500001	2	45	inc. 4 WD exc. vehicles with air suspension, load-dependent brake pressure regulator on axis 2 and level control	A	HD

Brand	Model	Year of construction	Item no.	Weight (kg)	Installation time (min)	Description	R = Additional- R = Replacement-Spring	Heav Duty for permanent loaded vehicles
Seat	Leon IV Hatchback (KL1)	11/2019-	405403500001	1,5	45	inc. 4 WD exc. vehicles with air suspension, load-dependent brake pressure regulator on axis 2 and level control exc. Cupra	A	
Seat	Leon IV Hatchback (KL1)	11/2019-	421676500001	2	45	inc. 4 WD exc. vehicles with air suspension, load-dependent brake pressure regulator on axis 2 and level control exc. Cupra	A	HD
Seat	Leon IV Sportstourer (KL8)	03/2020-	405403500001	1,5	45	inc. 4 WD exc. vehicles with air suspension, load-dependent brake pressure regulator on axis 2 and level control exc. Cupra	A	
Seat	Leon IV Sportstourer (KL8)	03/2020-	421676500001	2	45	inc. 4 WD exc. vehicles with air suspension, load-dependent brake pressure regulator on axis 2 and level control exc. Cupra	A	HD
Seat	Tarraco (KN2)	09/2018-	405403500001	1,5	45	for vehicles with multilink axles inc. 4 WD exc. vehicles with level control	A	
Seat	Tarraco (KN2)	09/2018-	421676500001	2	45	for vehicles with multilink axles inc. 4 WD exc. vehicles with level control	A	HD
Seat	Toledo III (5P2)	04/2004-05/2009	421600500001	1,3	30	inc. Ecomotive exc. vehicles with level control	A	
Skoda	Karoq Scout (NU7, ND7)	07/2017-	405403500001	1,5	60	for vehicles with multilink axles inc. 4 WD exc. vehicles with level control	A	

Brand	Model	Year of construction	Item no.	Weight (kg)	Installation time (min)	Description	R = Additional- R = Replacement-Spring	Heav Duty for permanent loaded vehicles
Skoda	Karoq Scout (NU7, ND7)	07/2017-	421676500001	2	45	for vehicles with multilink axles inc. 4 WD exc. vehicles with level control	A	HD
Skoda	Karoq (NU7, ND7)	07/2017-	405403500001	1,5	60	inc. 4 WD for vehicles with multilink axles exc. vehicles with level control exc. Sportsline	A	
Skoda	Karoq (NU7, ND7)	07/2017-	421676500001	2	45	inc. 4 WD for vehicles with multilink axles exc. vehicles with level control exc. Sportsline	A	HD
Skoda	Kodiaq Scout (NS7, NV7, NS6)	10/2016-	405403500001	1,5	45	inc. 4 WD exc. vehicles with level control	A	
Skoda	Kodiaq Scout (NS7, NV7, NS6)	10/2016-	421676500001	2	45	inc. 4 WD exc. vehicles with level control	A	HD
Skoda	Kodiaq (NS7, NV7, NS6)	10/2016-	405403500001	1,5	45	inc. 4 WD exc. vehicles with level control exc. Sportsline and RS	A	
Skoda	Kodiaq (NS7, NV7, NS6)	10/2016-	421676500001	2	45	inc. 4 WD exc. vehicles with level control exc. Sportsline and RS	A	HD
Skoda	Octavia II Combi (1Z5)	02/2004-06/2013	421600500001	1,3	30	inc. 4 WD and Greenline exc. vehicles with level control	A	
Skoda	Octavia II Saloon (1Z3)	02/2004-06/2013	421600500001	1,3	30	inc. 4 WD and Greenline exc. vehicles with level control	A	
Skoda	Octavia II Scout (1Z5)	02/2004-06/2013	421600500001	1,3	30	inc. 4 WD and Greenline exc. vehicles with level control	A	
Skoda	Octavia III Combi (5E5, 5E6)	11/2012-10/2020	405403500001	1,5	45	inc. 4 WD exc. vehicles with air suspension, load-dependent brake pressure regulator on axis 2 and level control exc. RS and Sportsline	A	

Brand	Model	Year of construction	Item no.	Weight (kg)	Installation time (min)	Description	R = Additional- R = Replacement-Spring	Heav Duty for permanent loaded vehicles
Skoda	Octavia III Combi (5E5, 5E6)	11/2012-10/2020	421676500001	2	45	inc. 4 WD exc. vehicles with air suspension, load-dependent brake pressure regulator on axis 2 and level control exc. RS and Sportsline	A	HD
Skoda	Octavia III Saloon (5E3, NL3, NR3)	11/2012-10/2020	405403500001	1,5	45	inc. 4 WD exc. vehicles with air suspension, load-dependent brake pressure regulator on axis 2 and level control exc. RS and Sportsline	A	
Skoda	Octavia III Saloon (5E3, NL3, NR3)	11/2012-10/2020	421676500001	2	45	inc. 4 WD exc. vehicles with air suspension, load-dependent brake pressure regulator on axis 2 and level control exc. RS and Sportsline	A	HD
Skoda	Octavia III Scout (5E5, 5E6)	11/2012-10/2020	405403500001	1,5	45	inc. 4 WD exc. vehicles with air suspension, load-dependent brake pressure regulator on axis 2 and level control	A	
Skoda	Octavia III Scout (5E5, 5E6)	11/2012-10/2020	421676500001	2	45	inc. 4 WD exc. vehicles with air suspension, load-dependent brake pressure regulator on axis 2 and level control	A	HD
Skoda	Octavia IV Combi (NX5)	11/2019-	405403500001	1,5	45	inc. 4 WD exc. vehicles with air suspension, load-dependent brake pressure regulator on axis 2 and level control exc. RS and Sportsline	A	
Skoda	Octavia IV Combi (NX5)	11/2019-	421676500001	2	45	inc. 4 WD exc. vehicles with air suspension, load-dependent brake pressure regulator on axis 2 and level control exc. RS and Sportsline	A	HD

Brand	Model	Year of construction	Item no.	Weight (kg)	Installation time (min)	Description	R = Additional- R = Replacement-Spring	Heav Duty for permanent loaded vehicles
Skoda	Octavia IV Saloon (NX3, NN3)	01/2020-	405403500001	1,5	45	inc. 4 WD exc. vehicles with air suspension, load-dependent brake pressure regulator on axis 2 and level control exc. RS and Sportsline	A	
Skoda	Octavia IV Saloon (NX3, NN3)	01/2020-	421676500001	2	45	inc. 4 WD exc. vehicles with air suspension, load-dependent brake pressure regulator on axis 2 and level control exc. RS and Sportsline	A	HD
Skoda	Octavia IV Scout (NX5)	11/2019-	405403500001	1,5	45	inc. 4 WD exc. vehicles with air suspension, load-dependent brake pressure regulator on axis 2 and level control	A	
Skoda	Octavia IV Scout (NX5)	11/2019-	421676500001	2	45	inc. 4 WD exc. vehicles with air suspension, load-dependent brake pressure regulator on axis 2 and level control	A	HD
Skoda	Superb II Combi (3T5)	10/2009-05/2015	421600500001	1,3	30	inc. 4 WD and Greenline exc. vehicles with level control	A	
Skoda	Superb II Saloon (3T4)	03/2008-05/2015	421600500001	1,3	30	inc. 4 WD and Greenline exc. vehicles with level control	A	
Skoda	Superb III Combi (3V5)	03/2015-	421676500001	2	45	inc. 4 WD exc. vehicles with level control exc. Sportsline	A	HD
Skoda	Superb III Combi (3V5)	03/2015-	405403500001	1,5	45	inc. 4 WD exc. vehicles with level control exc. Sportsline	A	
Skoda	Superb III Saloon (3V3)	03/2015-	421676500001	2	45	inc. 4 WD exc. vehicles with level control exc. Sportsline	A	HD

Brand	Model	Year of construction	Item no.	Weight (kg)	Installation time (min)	Description	R = Additional- R = Replacement-Spring	Heav Duty for permanent loaded vehicles
Skoda	Superb III Saloon (3V3)	03/2015-	405403500001	1,5	45	inc. 4 WD exc. vehicles with level control exc. Sportsline	A	
Skoda	Superb III Scout (3V5)	03/2015-	405403500001	1,5	45	inc. 4 WD exc. vehicles with level control	A	
Skoda	Superb III Scout (3V5)	03/2015-	421676500001	2	45	inc. 4 WD exc. vehicles with level control	A	HD
Skoda	Yeti (5L)	05/2009-12/2017	421600500001	1,3	30	inc. 4x4 and Greenline exc. vehicles with level control	A	
Suzuki	SX4 S-Cross (JY)	08/2013-12/2021	441001500001	1,5	45	inc. 4 WD exc. vehicles with level control	A	
Suzuki	Vitara (LY)	03/2015-	441001500001	1,5	45	inc. 4 WD exc. vehicles with level control	A	
Toyota	Auris Touring Sports (E18)	10/2012-12/2018	435003500001	1,4	45	inc. hybrid exc. 1.3 petrol, 1.4 diesel and 1.6 diesel exc. vehicles with level control	A	
Toyota	Auris (E18)	10/2012-12/2018	435003500001	1,4	45	inc. hybrid exc. 1.3 petrol, 1.4 diesel and 1.6 diesel exc. vehicles with level control	A	
Toyota	Avensis Station Wagon (T27)	02/2009-10/2018	435003500001	1,4	45	exc. vehicles with level control	A	
Toyota	Avensis (T27)	02/2009-10/2018	435003500001	1,4	45	exc. vehicles with level control	A	
Toyota	Proace City L1	10/2019-	404092500001	6,7	30	for vehicles with white PUR end stops only for front-wheel drive vehicles exc. vehicles with standard lift kit, air suspension, load-dependent brake pressure regulator on axle 2 and level control	R	

Brand	Model	Year of construction	Item no.	Weight (kg)	Installation time (min)	Description	R = Additional- R = Replacement-Spring	Heav Duty for permanent loaded vehicles
Toyota	Proace City L1 & L2	10/2019-	404131500001	7,1	30	for vehicles with white PUR end stops only for front-wheel drive vehicles exc. vehicles with standard lift kit, air suspension, load-dependent brake pressure regulator on axle 2 and level control	R	HD
Toyota	Proace (MDX)	06/2013-03/2016	404333500001	2,5	45	exc. vehicles with level control	A	
VW	Arteon (3H7)	03/2017-	405403500001	1,5	60	inc. 4motion exc. vehicles with level control exc. Arteon R	A	
VW	Arteon (3H7, 3H8)	04/2017-	421676500001	2	45	exc. vehicles with level control exc. Arteon R	A	HD
VW	Beetle Convertible (5C7, 5C8)	04/2011-07/2019	421600500001	1,3	30	only for vehicles with multilink-axles exc. vehicles with level control	A	
VW	Beetle (5C1 5C2)	04/2011-07/2019	421600500001	1,3	30	only for vehicles with multilink-axles exc. vehicles with level control	A	
VW	Caddy III Van (2K_,2C_)	03/2004-05/2015	421673500001	3,6	30	inc. Maxi, double leaf springs, EcoFuel, 4motion exc. Life and vehicles with load-dependent brake pressure regulators on axle 2	A	
VW	Caddy IV Van (SA_)	06/2015-09/2020	421673500001	3,6	30	inc. Maxi, double leaf springs, EcoFuel, 4motion exc. Life and vehicles with load-dependent brake pressure regulators on axle 2	A	
VW	Caddy V SBB, SB7	09/2020-	42678500001	7	30	exc. vehicles with lowered suspension, air suspension, load-dependent brake pressure regulator on axle 2 and level control	R	
VW	Crafter (2E/2F)	04/2006-12/2016	413376500001	10,9	60	only for vehicles with single tires exc. 4motion	A	

Brand	Model	Year of construction	Item no.	Weight (kg)	Installation time (min)	Description	R = Additional- R = Replacement-Spring	Heav Duty for permanent loaded vehicles
VW	Eos (1F7, 1F8)	03/2006-08/2015	421600500001	1,3	30	inc. Bluemotion exc. vehicles with level control	A	
VW	Golf Plus (5M1, 521)	01/2005-12/2013	421600500001	1,3	30	inc. 4motion and Bluemotion exc. vehicles with level control	A	
VW	Golf Sportsvan VII (AM1, AN1)	02/2014-08/2020	405403500001	1,5	45	exc. vehicles with level control	A	
VW	Golf Sportsvan VII (AM1, AN1)	02/2014-08/2020	421676500001	2	45	exc. vehicles with level control	A	HD
VW	Golf V Hatchback (1K1)	10/2003-02/2009	421600500001	1,3	30	inc. 4motion and Bluemotion exc. vehicles with level control exc. GTI and Golf R32	A	
VW	Golf V Variant (1K5)	06/2007-07/2009	421600500001	1,3	30	inc. 4motion and Bluemotion exc. vehicles with level control	A	
VW	Golf VI Variant (AJ5)	07/2009-07/2013	421600500001	1,3	30	inc. 4motion and Bluemotion exc. vehicles with level control	A	
VW	Golf VI (5K1)	10/2008-11/2013	421600500001	1,3	30	inc. 4motion and Bluemotion exc. vehicles with level control exc. GTI and Golf R	A	
VW	Golf VII Alltrack (BA5, BV5)	04/2013-08/2020	405403500001	1,5	45	inc. 4motion exc. vehicles with level control	A	
VW	Golf VII Alltrack (BA5, BV5)	04/2013-08/2020	421676500001	2	45	inc. 4motion exc. vehicles with level control	A	HD
VW	Golf VII Hatchback (5G1, BQ1, BE1, BE2)	08/2012-08/2020	405403500001	1,5	45	inc. 4motion exc. GTI and Golf R exc. vehicles with level control	A	
VW	Golf VII Hatchback (5G1, BQ1, BE1, BE2)	08/2012-08/2020	421676500001	2	45	inc. 4motion exc. GTI and Golf R exc. vehicles with level control	A	HD
VW	Golf VII Variant (BA5, BV5)	04/2013-08/2020	405403500001	1,5	45	inc. 4motion exc. vehicles with level control exc. Golf R	A	

Brand	Model	Year of construction	Item no.	Weight (kg)	Installation time (min)	Description	R = Additional- R = Replacement-Spring	Heav Duty for permanent loaded vehicles
VW	Golf VII Variant (BA5, BV5)	04/2013-08/2020	421676500001	2	45	inc. 4motion exc. vehicles with level control exc. Golf R	A	HD
VW	Golf VIII Alltrack (CG5)	08/2020-	405403500001	1,5	45	inc. 4motion exc. vehicles with level control	A	
VW	Golf VIII Alltrack (CG5)	08/2020-	421676500001	2	45	inc. 4motion exc. vehicles with level control	A	HD
VW	Golf VIII Hatchback (CD1)	07/2019-	405403500001	1,5	45	inc. 4motion exc. vehicles with level control exc. GTI and Golf R	A	
VW	Golf VIII Hatchback (CD1)	07/2019-	421676500001	2	45	inc. 4motion exc. vehicles with level control exc. GTI and Golf R	A	HD
VW	Golf VIII Variant (CG5)	08/2020-	405403500001	1,5	45	inc. 4motion exc. vehicles with level control exc. Golf R	A	
VW	Golf VIII Variant (CG5)	08/2020-	421676500001	2	45	inc. 4motion exc. vehicles with level control exc. Golf R	A	HD
VW	Jetta III (1K2)	08/2005-10/2010	421600500001	1,3	30	inc. 4motion and Bluemotion exc. vehicles with level control	A	
VW	Jetta IV (162, 163, AV2, AV3)	04/2010-12/2017	421600500001	1,3	30	inc. 4motion, Bluemotion and hybrid exc. vehicles with level control	A	
VW	Passat B6 CC (357)	02/2008-01/2012	421600500001	1,3	30	inc. 4motion and Bluemotion exc. vehicles with level control	A	
VW	Passat B6 Saloon (3C2)	03/2005-11/2010	421600500001	1,3	30	inc. 4motion and Bluemotion exc. vehicles with level control	A	
VW	Passat B6 Variant (3C5)	08/2005-11/2010	421600500001	1,3	30	inc. 4motion and Bluemotion exc. vehicles with level control	A	
VW	Passat B7 Saloon (362)	08/2010-12/2014	421600500001	1,3	30	inc. 4motion and Bluemotion exc. vehicles with level control	A	

Brand	Model	Year of construction	Item no.	Weight (kg)	Installation time (min)	Description	R = Additional- R = Replacement-Spring	Heav Duty for permanent loaded vehicles
VW	Passat B7 Variant (365)	08/2010-12/2015	421600500001	1,3	30	inc. 4motion and Bluemotion exc. vehicles with level control	A	
VW	Passat SaloonB8 (3G2, CB2)	08/2014-	405403500001	1,5	45	inc. 4motion exc. vehicles with level control	A	
VW	Passat Variant Alltrack B8 (3G5, CB5)	05/2015-	405403500001	1,5	45	inc. 4motion exc. vehicles with level control	A	
VW	Passat Variant B8 (3G5, CB5)	08/2014-	405403500001	1,5	45	inc. 4motion exc. vehicles with level control	A	
VW	Sharan (7N1, 7N2)	05/2010-	421600500001	1,3	30	inc. Bluemotion exc. vehicles with level control	A	
VW	Tiguan I (5N_)	09/2007-07/2018	421600500001	1,3	30	inc. 4motion and Bluemotion exc. vehicles with level control	A	
VW	Tiguan II Allspace (BW2, BJ2)	03/2017-	405403500001	1,5	45	inc. 4motion exc. vehicles with level control	A	
VW	Tiguan II Allspace (BW2, BJ2)	03/2017-	421676500001	2	45	inc. 4motion exc. vehicles with level control	A	HD
VW	Tiguan II (AD1, AX1)	01/2016-	405403500001	1,5	45	exc. Tiguan R inc. 4motion exc. vehicles with level control	A	
VW	Tiguan II (AD1, AX1)	01/2016-	421676500001	2	45	exc. Tiguan R inc. 4motion exc. vehicles with level control	A	HD
VW	Touran I (1T1, 1T2)	02/2003-05/2015	421600500001	1,3	30	inc. Bluemotion exc. vehicles with level control	A	
VW	Touran II (5T1)	05/2015-	405403500001	1,5	45		A	
VW	Touran II (5T1)	05/2015-	421676500001	2	45		A	HD
VW	Transporter T3 Van/Bus (24_, 25_)	05/1979-07/1992	421391500001	1,6	30	exc. Syncro	A	

Brand	Model	Year of construction	Item no.	Weight (kg)	Installation time (min)	Description	R = Additional- R = Replacement-Spring	Heav Duty for permanent loaded vehicles
VW	Transporter T4 Van/Bus (70_, 7D_)	07/1990-04/2003	421391500001	1,6	30	inc. Syncro and Caravelle up to 1,490 kg rear axle load with ALB controller	A	
VW	Transporter T5 Van (7H_, 7E_)	04/2003-08/2015	421651500001	1,6	30	inc. 4motion exc. vehicles with level control	A	
VW	Transporter T5 Van (7H_, 7E_)	04/2003-08/2015	421675500001	10,2	30	inc. 4motion	R	
VW	Transporter T5 Multivan (7H_, 7E_)	04/2003-08/2015	421651500001	1,6	30	inc. 4motion exc. vehicles with level control	A	
VW	Transporter T5 Multivan (7H_, 7E_)	04/2003-08/2015	421675500001	10,2	30	inc. 4motion	R	
VW	Transporter T5 Platform (7J_)	04/2003-08/2015	421651500001	1,6	30	inc. 4motion exc. vehicles with level control	A	
VW	Transporter T5 Platform (7J_)	04/2003-08/2015	421675500001	10,2	30	inc. 4motion	R	
VW	Transporter T6 Van (SG_, SH_)	04/2015-	421651500001	1,6	30	inc. 4motion exc. vehicles with level control	A	
VW	Transporter T6 Van (SG_, SH_)	04/2015-	421675500001	10,2	30	inc. 4motion	R	
VW	Transporter T6 Multivan (SG_, SH_)	04/2015-	421651500001	1,6	30	inc. 4motion exc. vehicles with level control	A	
VW	Transporter T6 Multivan (SG_, SH_)	04/2015-	421675500001	10,2	30	inc. 4motion	R	
VW	Transporter T6 Platform (SF_, SJ_)	04/2015-	421651500001	1,6	30	inc. 4motion exc. vehicles with level control	A	

Brand	Model	Year of construction	Item no.	Weight (kg)	Installation time (min)	Description	R = Additional- R = Replacement-Spring	Heav Duty for permanent loaded vehicles
VW	Transporter T6 Platform (SF_, SJ_)	04/2015-	421675500001	10,2	30	inc. 4motion	R	
VW	T-Roc (A11, D11)	07/2017-	405403500001	1,5	60	exc. T-Roc R for vehicles with multilink axles inc. 4motion	A	
VW	T-Roc (A11, D11)	07/2017-	421676500001	2	45	for vehicles with multilink axles inc. 4motion exc. vehicles with level control exc. T-Roc R	A	HD