



westfalia
AUTOMOTIVE

*Alles beginnt mit
der Anhängerkupplung.*



KATALOG **2024**



WESTFALIA-AUTOMOTIVE -BEWEGT DAS LEBEN!



westfalia-automotive.com

Die Produkte von Westfalia-Automotive:

Anhängerkupplungen

- zuverlässig und passgenau
- millionenfach bewährt
- Erstausrüsterqualität



Elektrosätze

- montagefreundlich
- hohe Zuverlässigkeit
- volle Funktionalität durch Bordnetzanbindung



Fahrzeugkodierung – Autocode

- einfache Bedienung
- schnelle Freischaltung



Fahrradträger

- einfaches Handling
- hohe Zuladung
- zusammenfaltbar



Verstärkungsfedern

- verbessertes Fahrverhalten
- erhöhte Fahrsicherheit
- geringerer Verschleiß von Fahrwerksteilen

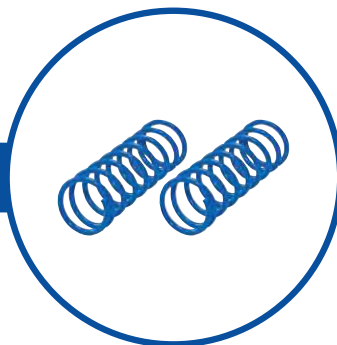



WESTFALIA-AUTOMOTIVE

Qualität Ihres Vertrauens

ALLES BEGINNT MIT DER ORIGINAL ANHÄNGEKUPPLUNG VON WESTFALIA-AUTOMOTIVE – FREIZEIT, SPORT, BERUF.

Sicherheit und Zuverlässigkeit. Seit über 85 Jahren bieten wir Ihnen mehr als 1.700 fahrzeugspezifische Anhängervorrichtungstypen höchster Präzision. Dazu erhalten Sie passende Elektrosätze und Codingtools. Abgerundet wird das Portfolio durch starke Trägersysteme für die Anhängerkupplung sowie durch Verstärkungsfedern und Zubehör.

Als Teil der First Brands Group agiert Westfalia-Automotive global. Sie profitieren dabei von einem weltweiten Netzwerk, umfassendem Know-how und neusten Technologien. Westfalia-Automotive macht Ihre Arbeit leichter und sicherer. Mit stetiger Innovation, höchster Qualität und wirtschaftlichen Lösungen.

ENTDECKEN SIE JETZT:

Anhängerkupplungen

Elektrosätze

Fahrradträger

Verstärkungsfedern

Autocode



westfalia-automotive.com



DIE FIRMENGESCHICHTE

Als Erfinder der Kugelkopf-Anhängerkupplung mit weltweiten Patenten vertritt Westfalia-Automotive seit 1932 einen natürlichen Führungsanspruch. Denn die Geburt dieser genialen Idee charakterisiert die Fundamente, auf denen der nunmehr über 85 Jahre währende Erfolg beruht: stetige Innovation /// höchste Qualität /// maximale Sicherheit /// konsequente Kundenorientierung. Ein zusätzlicher Erfolgsmotor ist der zielgerichtete Ausbau des Sortiments, mit dem kontinuierlich neue Märkte, Zielgruppen und Partner aus der Automobilindustrie gewonnen werden.

Johann Bernard Knöbel gründet eine Schmiede und legt damit den Grundstein für Westfalia in Rheda-Wiedenbrück

1844

Mit dem Mutternsystem bringt Westfalia als erster Hersteller eine abnehmbare Anhängerkupplung auf den Markt

1966

Gründung der Westfalia-Automotive GmbH (Aufteilung der Westfalia-Werke GmbH & Co. nach den Produktbereichen Anhängerkupplungen, Anhänger und Wohnmobile)

1999

Übernahme des französischen Kupplungsherstellers SIARR

2006

Westfalia-Automotive bringt unter dem Namen „Portilo“ den kompaktesten Fahrradträger auf den Markt

2008

Markteinführung der vierten Generation von Anhängerkupplungen, dem Trailer Towing Assistant, im Audi Q7

2015

Westfalia-Automotive wird Teil der First Brands Group

2023

1932

Westfalia erfindet die Anhängerkupplung mit Kugelkopf

1987

Westfalia führt als erster Hersteller die vollautomatisch abnehmbare Anhängerkupplung auf den Markt ein

2002

Westfalia-Automotive bringt als erster Hersteller die elektrisch schwenkbare Kupplung in Serie auf den Markt

2007

Übernahme des schwedischen Kupplungsherstellers MONOFLEX

2012

Westfalia-Automotive wird bereits zum siebten Mal in Folge zur „Best Brand“ der „auto, motor und sport“ im Bereich Anhängerkupplungen gekürt

2016

Westfalia-Automotive wird Teil der Horizon Global Corporation, einem der weltweit führenden Anbieter von Anhänger- und Transportsystemen





FAHRRADTRÄGER

Das Multitalent

Der Fahrradträger von Westfalia-Automotive präsentiert sich mit veränderter Hecktraverse in einem neuen und innovativen Design. Entdecken Sie Ihr multifunktionelles Transportsystem für Freizeit, Sport und Beruf. Einfach in der Montage, extrem kompakt und mit der Testsiegermentalität besonders sicher.

Zuladung bis 60kg

E-Bike fähig

Abschließbar



klein zusammenfaltbar



moderne LED-Leuchten
(nicht bikeland classic)



flexible, gummierte Halterungen

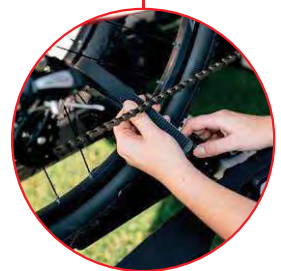

lange Spannriemen

IM TEST:



DAS GENIALE: Ganz leicht lässt sich der bikeland mit einer Box oder einer Plattform ergänzen. Mit der Box haben Sie schnell 220 Liter zusätzlichen Stauraum. Nasse, dreckige oder geruchsintensive Sachen lassen sich so bequem außerhalb des Fahrzeugs mitführen. Auf der praktischen Plattform verstauen Sie sicher sperrige Materialien und Sportgeräte. Weiteres praktisches Zubehör rundet das Programm ab.





KITS

Die perfekte Verbindung.

Anhängekupplungen und Elektrosätze von Westfalia-Automotive bilden die perfekte Partnerschaft. Passgenau aufgrund eigener Entwicklung und Fertigung bietet Ihnen das System die höchste Sicherheit. Die Einbindung ins Bordnetzsystem ist besonders einfach.

Ideale Verbindung

Passgenauer Einbau

Wirtschaftliche Montage

ANHÄNGEKUPPLUNG

- schwenkbare, abnehmbare oder starre Systeme
- zuverlässig
- Erstausrüsterqualität
- passgenau
- bedienerfreundlich
- millionenfach bewährt
- EG-genehmigt

FAHRZEUGSPEZIFISCHER ELEKTROSATZ

- Verwendung von Originalteilen
- montagefreundlich
- hohe Zuverlässigkeit
- vollständiges Produktprogramm
- volle Funktionalität durch Bordnetzanbindung

DAS GENIALE: Mit nur einer Artikel-Nummer und einem Bestellvorgang erhalten Sie mit unseren Kits einen echten Preisvorteil.



immer wieder ausgezeichnet

Westfalia-Automotive wurde 7x in Folge „Best Brand“! Bei der Wahl „Best Brand“ kürten die Leser der Zeitschrift „auto motor und sport“ Westfalia-Automotive zum Sieger in der Kategorie „Anhängekupplungen“.



SCHWENKBARE ANHÄNGEVORRICHTUNGEN

Immer einsatzbereit – DIE R10

Die schwenkbare Anhängerkupplung ist die Komfortausführung der Anhängervorrichtung. Nur ein Knopfdruck und sie steht zur Verfügung – egal, ob Sie eine Tour mit dem Fahrradträger unternehmen wollen oder einen Wohn- oder Allzweckanhänger ziehen möchten.

PRAKTISCH | SICHER | KOMFORTABEL



Komfortables Handling

Passgenau und montagefreundlich

Wartungsfrei

DIE ANHÄNGEVORRICHTUNG BIETET

- Sichere Verriegelung durch Optik- und Akustiksignal
- System arbeitet autark -> keine zusätzliche Programmierung des Schwenkmoduls notwendig
- Nahezu unsichtbar bei Nichtgebrauch
- 13-poliger, fahrzeugspezifischer Elektrosatz inklusive
- Steckdosenhalter auf der Kugelstange montiert
- Integrierte Öse für Sicherungsseil (ECE55R geprüft)
- EG-Genehmigung

DAS GENIALE: Die Kugelstange ist auch bei Nichtgebrauch immer dabei, ohne abgenommen und verstaut werden zu müssen.

FAHRZEUGCODIERUNG

AUTOCODE-REMOTE

Noch nie war Fahrzeugcodierung so unkompliziert.

Nach erfolgreicher Registrierung verbinden Sie Ihr Autocode-Remote mit dem OBD-Port des Fahrzeugs, öffnen auf einem Endgerät Ihrer Wahl unser Portal und wählen Ihre Codierung aus. Der Preis wird Ihnen direkt ohne zusätzliche Kosten angezeigt. Anschließend erfolgt die Codierung mittels Fernwartung durch ein Expertenteam, fast als wenn der Techniker neben Ihnen sitzen würde.

„Remote Diagnostics“ von Westfalia-Automotive für eine Vielzahl von Modellen und Anwendungen und eine reibungslose Fahrzeugcodierung.



Remote Diagnostics

Fernwartung durch erfahrene Experten

Einfache Handhabung

Fahrzeugcodierung quasi auf Knopfdruck

Eine Lösung für alles

von A wie Airbag bis Z wie Zündschlüssel

Volle Kostentransparenz und -kontrolle

keine versteckten Kosten





VERSTÄRKUNGSFEDERN

Endlich was gegen „weiche Knie“

Einfach und effektiv. Unter extremen Bedingungen, wie plötzlichen Ausweichmanövern, verhält sich ein schwerbeladenes Fahrzeug mit zusätzlichen Verstärkungsfedern deutlich besser. Für Caravan-Gespanne und gewerbliche Kleintransporter ein deutliches Plus an Sicherheit. Die Verstärkungsfedern sind die ideale Ergänzung zu einer Anhängerkupplung von Westfalia-Automotive, denn bei einem gemeinsamen Verbau in der Werkstatt entstehen Synergieeffekte.

Erhöhte Sicherheit

Bestes Fahrverhalten

TÜV-geprüft

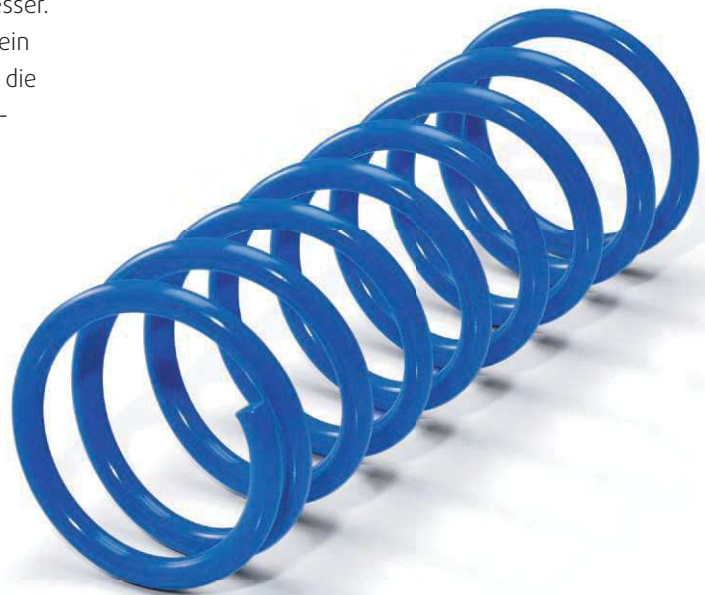

SLALOM- UND AUSWEICHTEST MIT 300 KG BELADUNG IM KOFFERRAUM.

OHNE VERSTÄRKUNGSFEDERN (Abb. links)

Schwere Ladung kann die serienmäßige Federung des Fahrzeugs überfordern – es geht hinten „in die Knie“. Die Folge: Längere Bremswege, Schleudergefahr und Pendeln in Kurven bei Seitenwind und bei Überholmanövern. Dazu kommt eine stärkere Übertragung von Bodenwellen, Unebenheiten und Schlaglöchern. Alles Gründe, um die Serienfederung Ihres Fahrzeugs bei Beladung zu verstärken.

MIT VERSTÄRKUNGSFEDERN (Abb. rechts)

Die Westfalia-Automotive-Verstärkungsfedern sind ebenso effektiv wie einfach konstruiert. Durch ihre zusätzliche Kraft verhindern sie, dass das Fahrzeug „in die Knie geht“. Sie halten es stabil auf der Straße und sorgen für einen besseren Grip der Vorderräder und für einen sicheren Bremsweg. Schwere Lasten können leichter befördert werden, und das Risiko von schlingernden Anhängern oder Caravans wird minimiert.

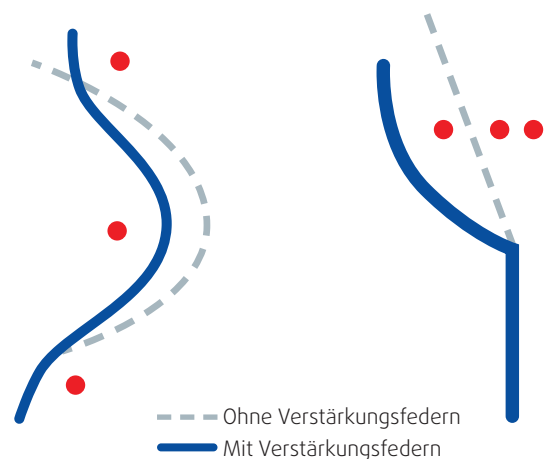



WAM-NET

Immer auf dem neuesten Stand

Wer informiert ist, hat immer einen großen Vorsprung. Im Westfalia-Internet finden Sie auf nahezu jede Frage die richtige Antwort. Probieren Sie es einfach mal aus.

Viele Einbautipps

Verkaufsförderung

Bestands-Check



JETZT EINFACH TESTEN UND BEGEISTERT SEIN.

Legen Sie sich kostenlos ein Kundenkonto an und profitieren Sie z.B. von:

Newsletter-Registrierung:

Monatliche Info über Produktneuheiten, -änderungen und News

Verfügbarkeitsabfrage von Produkten:

Immer wissen, was im Zentrallager vorrätig ist

Einbauanleitungen:

Downloadmöglichkeit der aktuellsten Versionen

Werkstatt-Unterstützung:

Tipps & Tricks, FAQs



Legende Anhängerkupplungen

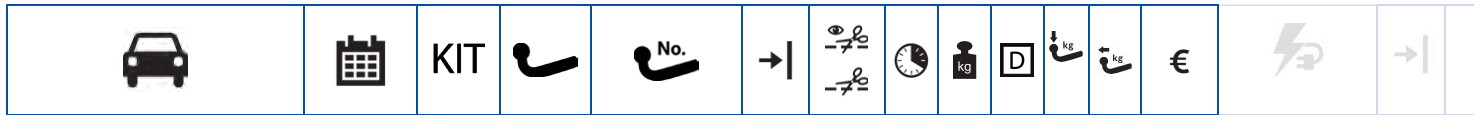

- Fahrzeug
- Baujahr
- KIT** Anhängerkupplung + fahrzeugspezifischer Elektrosatz
- Anhängerkupplung-System
- Art.-Nr. Anhängerkupplung
- Auslaufmodell
- sichtbarer Ausschnitt
- unsichtbarer Ausschnitt
- Einbauzeit
- Eigengewicht
- D-Wert kN
- Stützlast
- Anhängelast
- Listenpreis ohne MwSt.

<p>A40H abnehmbar Automatiksystem horizontal</p>	<p>A40V abnehmbar Automatiksystem vertikal</p>	<p>A50 abnehmbar kleine Automatik</p>	<p>A10H abnehmbar Automatiksystem vertikal</p>
<p>F20 starr geschraubte Ausführung</p>	<p>F10 starr geschweißte Ausführung</p>	<p>F40 Anhängebock für Kugelplatte (4 Schrauben)</p>	<p>F30 Anhängebock für Kugelplatte (2 Schrauben)</p>
<p>R10 schwenkbar elektrische Auslösung</p>	<p>RH Receiver Hitch</p>		

Legende Elektrosätze



- Auslaufmodell
- Zusatzinformationen E-Satz
- S** Elektro-Satz **fahrzeugspezifisch**
-- Elektro-Satz **universal**
Nr. ...1.7 = 7-polig
Nr. ...1.3 = 13-polig
- C2** Blinküberwachung **C2-Kontrollleuchte**
A Blinküberwachung **akustisch**
CAN Blinküberwachung **CAN**
FRE Blinküberwachung **Blinkfrequenz**
- C** Codierung/Freischaltung notwendig
C1 ohne Codierung möglich -> Blinküberwachung C2 über Buzzer
-- Codierung/Freischaltung **nicht** notwendig
- E** EPH-Abschaltung
E1 EPH-Abschaltung (Vorrüstung universell)
E2 EPH-Abschaltung (Taster im Armaturenfeld) falls vorhanden
-- keine EPH-Abschaltung
- D** Dauerplus enthalten
D1 Dauerplus optional (Ergänzungskit 300027300113)
-- kein Dauerplus
- L** Ladeleitung enthalten
L1 Ladeleitung optional (Ergänzungskit 300028300113)
-- keine Ladeleitung
- V** Anschluss vorn
H Anschluss hinten
- Einbauzeit

Sehr geehrter Kunde,

Ihnen liegt nun der neue Westfalia-Automotive-Katalog für Anhängerkupplungen, Elektrosätze und Transportsysteme für das Jahr 2024 vor. Wir haben uns auch dieses Mal bemüht, Ihre Vorschläge und Änderungswünsche einzuarbeiten, und sind sicher, Ihnen mit diesem wichtigen Werkzeug für das Tagesgeschäft die Voraussetzungen für erfolgreiche Geschäfte an die Hand geben zu können.

Bitte beachten Sie folgende Hinweise:

Legende

Die Legende zu den Spalten des Katalogs finden Sie auf den ersten Seiten dieses Katalog.

KIT = Anhängerkupplung + Elektrosatz 13-polig

Unser Kit-Programm ist auch dieses Mal um eine Vielzahl von Anhängerkupplungen erweitert worden. Sie finden jetzt zu fast jeder Kupplung mit fahrzeugspezifischem Elektrosatz ein Kit. Die Artikelnummern für die Kits erkennen Sie an der Endnummer ...900113.

Montagezeiten

Bei den Angaben der Montagezeiten handelt es sich um unverbindliche Richtwerte für unsere Produkte, die je nach Erhaltungszustand des Fahrzeuges oder den Fähigkeiten bzw. den Erfahrungswerten des Monteurs von dem tatsächlichen Aufwand abweichen können. Unter ungünstigen Umständen kann auch ein stark von der Grundausstattung abweichender Ausrüstungsgrad des Fahrzeuges die Montagezeiten negativ beeinflussen, wenn z.B. ein CD-Wechsler zur Montage der E-Anlage ausgebaut werden muss. Beschränken Sie bei Montage- oder Funktionsproblemen die Fehlersuche auf ca. 0,5 Stunden für mechanische bzw. 0,75 Stunden für elektrische Arbeiten. Kontaktieren Sie bei Montage- oder Funktionsproblemen den Westfalia Kundendienst.

Fahrzeuge mit Einparksensoren

Bei der Montage von starren Anhängervorrichtungen kann die Kugel im Erfassungsbereich der Sensoren liegen. Ob die gewünschte Funktion der Einparkhilfe in dieser Kombination gewährleistet ist, muss in jedem Einzelfall geprüft werden. Abhilfe bietet die abnehmbare Variante der Anhängerkupplung, sofern diese verfügbar ist und die Kugelstange bei Nichtbenutzung entsprechend demontiert wird.

Vor Montage einer Anhängerkupplung und eines Elektrosatzes gilt:



























Bitte beachten Sie in jedem Fall die Hinweise des Fahrzeugherstellers in der Betriebsanleitung des Fahrzeuges.

















Anhängerkupplungen und Anhängelast

Bitte prüfen Sie, ob in den Fahrzeugpapieren eine Anhängelast eingetragen ist. Falls nicht, ist der Anbau einer Anhängervorrichtung vom Fahrzeughersteller nicht freigegeben und somit nicht erlaubt. Bitte beachten Sie hierzu auch die Betriebserlaubnis des Fahrzeuges.

Einen aktuellen Produktfinder, weiterführende Informationen sowie Fragen und Antworten zu unseren Produkten finden Sie auf unserer Website westfalia-automotive.com















Alfa Romeo











Alfa 159 Limousine nicht für GTA - 250 PS	09/06-10/11			306 356 600 001		120	25.0	9.9	100	1800		306 220 300 113	→		S	FRE	--	E	D	L1	H	90	
		KIT		306 356 900 113	→		120	27.0	9.9	100	1800		im KIT enthalten 306 220 300 113	→		S	FRE	--	E	D	L1	H	90
Alfa 159 Sportwagon	03/06-10/11			306 356 600 001		120	25.0	9.9	100	1800		306 220 300 113	→		S	FRE	--	E	D	L1	H	90	
		KIT		306 356 900 113	→		120	27.0	9.9	100	1800		im KIT enthalten 306 220 300 113	→		S	FRE	--	E	D	L1	H	90
Alfa Giulia nicht für Quadrifoglio auch für Veloce	05/16-			306 387 600 001		90	23.0	9.2	100	1600		306 471 300 113			S	FRE	--	E	D	L1	H	90	
		KIT		306 387 900 113			90	24.1	9.2	100	1600		im KIT enthalten 306 471 300 113			S	FRE	--	E	D	L1	H	90
Alfa Giulietta	04/10-12/20			306 372 600 001		90	25.0	7.7	90	1500		306 371 300 113			S	FRE	--	E	D1	L1	V	105	
Alfa Mito	09/08-07/18			306 375 600 001		90	19.0	6.7	75	1100		300 078 300 113		09/08-07/18	--	FRE	--	--	D1	L1	V		
				306 374 600 001		90	19.0	6.7	75	1100		306 606 300 113	→		S	FRE	--	E	D1	L1	V	105	
Alfa Stelvio nicht für Quadrifoglio	12/16-			306 518 600 001		60	24.1	11.8	120	2400		306 451 300 113		12/16- auch für Facelift 21-	S	FRE	--	E	D	L1	H	120	
				306 519 600 001		60	25.4	11.8	120	2400													
		KIT		306 518 900 113			60	25.0	11.8	120	2400		im KIT enthalten 306 451 300 113		12/16- auch für Facelift 21-	S	FRE	--	E	D	L1	H	120
		KIT		306 519 900 113			60	28.0	11.8	120	2400		im KIT enthalten 306 451 300 113		12/16- auch für Facelift 21-	S	FRE	--	E	D	L1	H	120

Audi A1	08/10-10/18		317 113 600 001		40	14.5	7.2	86	1200	305 329 300 113	mit Vorrüstung	S	CAN	C	E	D	L1	H		
										305 330 300 001	Erweiterungssatz für Kfz. ohne schwarzen Sicherungshalter auf der Beifahrerseite	S				D1		V	60	
										305 330 300 113	ohne Vorrüstung	S	CAN	C	E	D1	L1	V		
Audi A1 Bitte Spoiler und Klappe für Stoßfängerausschnitt beim Audi-Händler bestellen.	08/10-10/18		317 114 600 001		40	15.0	7.2	86	1200	305 329 300 113	mit Vorrüstung	S	CAN	C	E	D	L1	H		
										305 330 300 001	Erweiterungssatz für Kfz. ohne schwarzen Sicherungshalter auf der Beifahrerseite	S				D1		V	60	
										305 330 300 113	ohne Vorrüstung	S	CAN	C	E	D1	L1	V		
Audi A1 Sportback	02/12-10/18		317 113 600 001		40	14.5	7.2	86	1200	305 329 300 113	mit Vorrüstung	S	CAN	C	E	D	L1	H		
										305 330 300 001	Erweiterungssatz für Kfz. ohne schwarzen Sicherungshalter auf der Beifahrerseite	S				D1		V	60	
										305 330 300 113	ohne Vorrüstung	S	CAN	C	E	D1	L1	V		
Audi A1 Sportback Bitte Spoiler und Klappe für Stoßfängerausschnitt beim Audi-Händler bestellen.	02/12-10/18		317 114 600 001		40	15.0	7.2	86	1200	305 329 300 113	mit Vorrüstung	S	CAN	C	E	D	L1	H		
										305 330 300 001	Erweiterungssatz für Kfz. ohne schwarzen Sicherungshalter auf der Beifahrerseite	S				D1		V	60	
										305 330 300 113	ohne Vorrüstung	S	CAN	C	E	D1	L1	V		
Audi A3 nicht für Quattro + S3 Bitte Dichtung für Rahmen mitbestellen, Art.-Nr. 900002504014	09/96-05/03		305 222 600 001		120	17.5	8.9	75	1650	305 223 300 113		S	FRE	--	E	D1	L1	V	60	
												305 223 600 001		120	16.8	8.9	75	1650		
		KIT		305 391 900 113		120	19.5	8.9	75	1650	im KIT enthalten 305 223 300 113		S	FRE	--	E	D1	L1	V	60
				305 392 900 113		120	18.8	8.9	75	1650	im KIT enthalten 305 223 300 113		S	FRE	--	E	D1	L1	V	60











Audi













Audi

Audi A3 Cabrio S3-Modelle 04/08-: Bitte prüfen, ob das Fzg. für den Anhängerbetrieb zugelassen ist.	04/08-03/14			321 865 600 001		60	17.0	9.4	100	1800		305 256 300 113			S	CAN	C	E	D1	--	V	120
		KIT		305 389 900 113		60	19.0	9.4	100	1800		im KIT enthalten 305 256 300 113			S	CAN	C	E	D1	--	V	120
Audi A3 Cabrio auch für S-Line S3-Modelle 04/08-: Bitte prüfen, ob das Fzg. für den Anhängerbetrieb zugelassen ist. Spoiler inkl. Klappe bitte beim Audi-Händler bestellen.	04/08-03/14			321 885 600 001		60	17.0	9.4	100	1800		305 256 300 113			S	CAN	C	E	D1	--	V	120
		KIT		305 390 900 113		60	19.0	9.4	100	1800		im KIT enthalten 305 256 300 113			S	CAN	C	E	D1	--	V	120
Audi A3 Cabrio für Fzg. ohne Vorrüstung nicht für Quattro Spoiler inkl. Abdeckklappe bitte beim Audi-Händler bestellen. Achtung: Je nach Motorvariante können Änderungen am Kühlsystem des Fahrzeugs notwendig sein.	03/14-06/14	KIT		317 132 900 113		60	21.0	10.3	85	2000		im KIT enthalten 305 406 300 113		-06/14 für Fzg. ohne Vorrüstung	S	CAN	C	E	D	L1	V	150
Audi A3 Cabrio für Fzg. ohne Vorrüstung nicht für Quattro Achtung: Je nach Motorvariante können Änderungen am Kühlsystem des Fahrzeugs notwendig sein.	03/14-06/14	KIT		317 131 900 113		60	21.0	10.3	85	2000		im KIT enthalten 305 406 300 113		-06/14 für Fzg. ohne Vorrüstung	S	CAN	C	E	D	L1	V	150
Audi A3 Cabrio nicht für Quattro Spoiler inkl. Abdeckklappe bitte beim Audi-Händler bestellen. Achtung: Je nach Motorvariante können Änderungen am Kühlsystem des Fahrzeugs notwendig sein.	03/14-05/16			317 132 600 001		60	19.0	10.3	85	2000		305 403 300 113		-06/14 für Fzg. mit Vorrüstung	S	CAN	C	E	D	L1	H	45
												305 406 300 113		-06/14 für Fzg. ohne Vorrüstung	S	CAN	C	E	D	L1	V	150
												305 407 300 113		06/14- für Fzg. mit Vorrüstung	S	CAN	C	E	D	L	H	30
												305 408 300 107	→	06/14- für Fzg. ohne Vorrüstung	S	CAN	C	E	--	--	V	60
												305 408 300 113		06/14- für Fzg. ohne Vorrüstung	S	CAN	C	E	D	L	V	60

















Audi A3 Cabrio nicht für Quattro Achtung: Je nach Motorvariante können Änderungen am Kühlsystem des Fahrzeugs notwendig sein.	03/14-05/16		317 131 600 001		60	19.0	10.3	85	2000	305 403 300 113	-06/14 für Fzg. mit Vorrüstung	S	CAN	C	E	D	L1	H	45	
										305 406 300 113	-06/14 für Fzg. ohne Vorrüstung	S	CAN	C	E	D	L1	V	150	
										305 407 300 113	06/14- für Fzg. mit Vorrüstung	S	CAN	C	E	D	L	H	30	
										305 408 300 107	→ 06/14- für Fzg. ohne Vorrüstung	S	CAN	C	E	--	--	V	60	
										305 408 300 113	06/14- für Fzg. ohne Vorrüstung	S	CAN	C	E	D	L	V	60	
Audi A3 Cabrio für Fzg. ohne Vorrüstung nicht für Quattro Achtung: Je nach Motorvariante können Änderungen am Kühlsystem des Fahrzeugs notwendig sein.	03/14-05/16	KIT		305 418 900 113		60	20.9	10.3	85	2000	im KIT enthalten 305 438 300 113	inkl. WLC 2.0 für Fzg. ohne Vorrüstung	S	CAN	C	E	D	L1	V	90
Audi A3 Cabrio für Fzg. ohne Vorrüstung nicht für Quattro Spoiler inkl. Abdeckklappe bitte beim Audi-Händler bestellen. Achtung: Je nach Motorvariante können Änderungen am Kühlsystem des Fahrzeugs notwendig sein.	03/14-05/16	KIT		305 419 900 113		60	20.9	10.3	85	2000	im KIT enthalten 305 438 300 113	inkl. WLC 2.0 für Fzg. ohne Vorrüstung	S	CAN	C	E	D	L1	V	90
Audi A3 Cabrio für Fzg. ohne Vorrüstung nicht für Quattro Spoiler inkl. Abdeckklappe bitte beim Audi-Händler bestellen. Achtung: Je nach Motorvariante können Änderungen am Kühlsystem des Fahrzeugs notwendig sein.	06/14-05/16	KIT		305 409 900 113		60	21.0	10.3	85	2000	im KIT enthalten 305 408 300 113	06/14- für Fzg. ohne Vorrüstung	S	CAN	C	E	D	L	V	60
Audi A3 Cabrio für Fzg. ohne Vorrüstung nicht für Quattro Achtung: Je nach Motorvariante können Änderungen am Kühlsystem des Fahrzeugs notwendig sein.	06/14-05/16	KIT		305 408 900 113		60	19.0	10.3	85	2000	im KIT enthalten 305 408 300 113	06/14- für Fzg. ohne Vorrüstung	S	CAN	C	E	D	L	V	60









Audi

Audi A3 Cabrio für Fzg. mit Vorrüstung nicht für Quattro Spoiler inkl. Abdeckklappe bitte beim Audi-Händler bestellen. Achtung: Je nach Motorvariante können Änderungen am Kühlsystem des Fahrzeugs notwendig sein.	06/14-05/16	KIT		317 155 900 113		60	20.5	10.3	85	2000		im KIT enthalten 305 407 300 113		06/14- für Fzg. mit Vorrüstung	S	CAN	C	E	D	L	H	30	
Audi A3 Cabrio für Fzg. mit Vorrüstung nicht für Quattro Achtung: Je nach Motorvariante können Änderungen am Kühlsystem des Fahrzeugs notwendig sein.	06/14-05/16	KIT		317 154 900 113		60	20.5	10.3	85	2000		im KIT enthalten 305 407 300 113		06/14- für Fzg. mit Vorrüstung	S	CAN	C	E	D	L	H	30	
Audi A3 Limousine für Fzg. ohne Vorrüstung Spoiler inkl. Abdeckklappe bitte beim Audi-Händler bestellen. Achtung: Je nach Motorvariante können Änderungen am Kühlsystem des Fahrzeugs notwendig sein.	09/13-06/14	KIT		317 132 900 113		60	21.0	10.3	85	2000		im KIT enthalten 305 406 300 113		-06/14 für Fzg. ohne Vorrüstung	S	CAN	C	E	D	L1	V	150	
Audi A3 Limousine für Fzg. ohne Vorrüstung Achtung: Je nach Motorvariante können Änderungen am Kühlsystem des Fahrzeugs notwendig sein.	09/13-06/14	KIT		317 131 900 113		60	21.0	10.3	85	2000		im KIT enthalten 305 406 300 113		-06/14 für Fzg. ohne Vorrüstung	S	CAN	C	E	D	L1	V	150	
Audi A3 Limousine Achtung: Je nach Motorvariante können Änderungen am Kühlsystem des Fahrzeugs notwendig sein.	09/13-05/16			317 131 600 001		60	19.0	10.3	85	2000		305 403 300 113		-06/14 für Fzg. mit Vorrüstung	S	CAN	C	E	D	L1	H	45	
												305 406 300 113		-06/14 für Fzg. ohne Vorrüstung	S	CAN	C	E	D	L1	V	150	
												305 407 300 113		06/14-11/19 für Fzg. mit Vorrüstung	S	CAN	C	E	D	L	H	30	
												305 408 300 107	→	06/14-11/19 für Fzg. ohne Vorrüstung	S	CAN	C	E	--	--	V	60	
												305 408 300 113		06/14-11/19 für Fzg. ohne Vorrüstung	S	CAN	C	E	D	L	V	60	















Audi A3 Limousine Spoiler inkl. Abdeckklappe bitte beim Audi-Händler bestellen. Achtung: Je nach Motorvariante können Änderungen am Kühlsystem des Fahrzeugs notwendig sein.	09/13-05/16		317 132 600 001		60	19.0	10.3	85	2000		305 403 300 113	-06/14 für Fzg. mit Vorrüstung	S	CAN	C	E	D	L1	H	45	
											305 406 300 113	-06/14 für Fzg. ohne Vorrüstung	S	CAN	C	E	D	L1	V	150	
											305 407 300 113	06/14-11/19 für Fzg. mit Vorrüstung	S	CAN	C	E	D	L	H	30	
											305 408 300 107	06/14-11/19 für Fzg. ohne Vorrüstung	S	CAN	C	E	--	--	V	60	
											305 408 300 113	06/14-11/19 für Fzg. ohne Vorrüstung	S	CAN	C	E	D	L	V	60	
Audi A3 Limousine für Fzg. ohne Vorrüstung Achtung: Je nach Motorvariante können Änderungen am Kühlsystem des Fahrzeugs notwendig sein.	09/13-05/16	KIT		305 418 900 113		60	20.9	10.3	85	2000		im KIT enthalten 305 438 300 113	inkl. WLC 2.0 für Fzg. ohne Vorrüstung	S	CAN	C	E	D	L1	V	90
Audi A3 Limousine für Fzg. ohne Vorrüstung Spoiler inkl. Abdeckklappe bitte beim Audi-Händler bestellen. Achtung: Je nach Motorvariante können Änderungen am Kühlsystem des Fahrzeugs notwendig sein.	09/13-05/16	KIT		305 419 900 113		60	20.9	10.3	85	2000		im KIT enthalten 305 438 300 113	inkl. WLC 2.0 für Fzg. ohne Vorrüstung	S	CAN	C	E	D	L1	V	90
Audi A3 Limousine für Fzg. ohne Vorrüstung Spoiler inkl. Abdeckklappe bitte beim Audi-Händler bestellen. Achtung: Je nach Motorvariante können Änderungen am Kühlsystem des Fahrzeugs notwendig sein.	06/14-05/16	KIT		305 409 900 113		60	21.0	10.3	85	2000		im KIT enthalten 305 408 300 113	06/14-11/19 für Fzg. ohne Vorrüstung	S	CAN	C	E	D	L	V	60
Audi A3 Limousine für Fzg. ohne Vorrüstung Achtung: Je nach Motorvariante können Änderungen am Kühlsystem des Fahrzeugs notwendig sein.	06/14-05/16	KIT		305 408 900 113		60	19.0	10.3	85	2000		im KIT enthalten 305 408 300 113	06/14-11/19 für Fzg. ohne Vorrüstung	S	CAN	C	E	D	L	V	60
Audi A3 Limousine für Fzg. mit Vorrüstung Spoiler inkl. Abdeckklappe bitte beim Audi-Händler bestellen. Achtung: Je nach Motorvariante können Änderungen am Kühlsystem des Fahrzeugs notwendig sein.	06/14-05/16	KIT		317 155 900 113		60	20.5	10.3	85	2000		im KIT enthalten 305 407 300 113	06/14-11/19 für Fzg. mit Vorrüstung	S	CAN	C	E	D	L	H	30

Audi

Audi A3 Limousine für Fzg. mit Vorrüstung Achtung: Je nach Motorvariante können Änderungen am Kühlsystem des Fahrzeugs notwendig sein.	06/14-05/16	KIT		317 154 900 113		60	20.5	10.3	85	2000		im KIT enthalten 305 407 300 113		06/14-11/19 für Fzg. mit Vorrüstung	S	CAN	C	E	D	L	H	30
Audi A3 Limousine (8Y) auch für S-Line auch für AdBlue auch für Hybrid	04/20-			322 094 600 001		60	17.7	12.3	150	2500		322 080 300 113		für Fzg. ohne Vorrüstung	S	CAN	C	E	D	L	V	120
Audi A3 Limousine (8Y) für Fzg. ohne Vorrüstung auch für S-Line auch für AdBlue auch für Hybrid	04/20-	KIT		322 094 900 113		60	19.6	12.3	150	2500		im KIT enthalten 322 080 300 113		für Fzg. ohne Vorrüstung	S	CAN	C	E	D	L	V	120
Audi A3 Sportback, 5-Türer auch für Quattro, V6 3,2 l (250 PS), Facelift 06/08-S3-Modelle 04/08-: Bitte prüfen, ob das Fzg. für den Anhängerbetrieb zugelassen ist.	09/04-01/13			305 299 600 001		120	16.5	9.7	100	1800		305 256 300 113			S	CAN	C	E	D1	--	V	120
Audi A3 Sportback, 5-Türer auch für Quattro, S-Line, V6 3,2 l (250 PS), Facelift 06/08-S3-Modelle 04/08-: Bitte prüfen, ob das Fzg. für den Anhängerbetrieb zugelassen ist. Bitte Spoiler (inkl. Klappe) beim Audi-Händler bestellen.	09/04-01/13			305 300 600 001		120	17.5	9.7	100	1800		305 256 300 113			S	CAN	C	E	D1	--	V	120
		KIT		305 300 900 113		120	18.5	9.7	100	1800		im KIT enthalten 305 256 300 113			S	CAN	C	E	D1	--	V	120
Audi A3 Sportback, 5-Türer für Fzg. ohne Vorrüstung Achtung: Je nach Motorvariante können Änderungen am Kühlsystem des Fahrzeugs notwendig sein.	02/13-06/14	KIT		317 131 900 113		60	21.0	10.3	85	2000		im KIT enthalten 305 406 300 113		-06/14 für Fzg. ohne Vorrüstung	S	CAN	C	E	D	L1	V	150
Audi A3 Sportback, 5-Türer für Fzg. ohne Vorrüstung Spoiler inkl. Abdeckklappe bitte beim Audi-Händler bestellen. Achtung: Je nach Motorvariante können Änderungen am Kühlsystem des Fahrzeugs notwendig sein.	02/13-06/14	KIT		317 132 900 113		60	21.0	10.3	85	2000		im KIT enthalten 305 406 300 113		-06/14 für Fzg. ohne Vorrüstung	S	CAN	C	E	D	L1	V	150









Audi A3 Sportback, 5-Türer Spoiler inkl. Abdeckklappe bitte beim Audi-Händler bestellen. Achtung: Je nach Motorvariante können Änderungen am Kühlsystem des Fahrzeugs notwendig sein.	02/13-06/16		317 132 600 001		60	19.0	10.3	85	2000	305 403 300 113	-06/14 für Fzg. mit Vorrüstung	S	CAN	C	E	D	L1	H	45	
										305 406 300 113	-06/14 für Fzg. ohne Vorrüstung	S	CAN	C	E	D	L1	V	150	
										305 407 300 113	06/14- für Fzg. mit Vorrüstung	S	CAN	C	E	D	L	H	30	
										305 408 300 107 →	06/14-11/19 für Fzg. ohne Vorrüstung	S	CAN	C	E	--	--	V	60	
										305 408 300 113	06/14-11/19 für Fzg. ohne Vorrüstung	S	CAN	C	E	D	L	V	60	
Audi A3 Sportback, 5-Türer für Fzg. ohne Vorrüstung Spoiler inkl. Abdeckklappe bitte beim Audi-Händler bestellen. Achtung: Je nach Motorvariante können Änderungen am Kühlsystem des Fahrzeugs notwendig sein.	02/13-06/16	KIT		305 419 900 113		60	20.9	10.3	85	2000	im KIT enthalten 305 438 300 113	inkl. WLC 2.0 für Fzg. ohne Vorrüstung	S	CAN	C	E	D	L1	V	90
Audi A3 Sportback, 5-Türer (8V) auch für Fzg. ab 07/16- Achtung: Je nach Motorvariante können Änderungen am Kühlsystem des Fahrzeugs notwendig sein.	02/13-11/19		317 131 600 001		60	19.0	10.3	85	2000	305 403 300 113	-06/14 für Fzg. mit Vorrüstung	S	CAN	C	E	D	L1	H	45	
										305 406 300 113	-06/14 für Fzg. ohne Vorrüstung	S	CAN	C	E	D	L1	V	150	
										305 407 300 113	06/14- für Fzg. mit Vorrüstung	S	CAN	C	E	D	L	H	30	
										305 408 300 107 →	06/14-11/19 für Fzg. ohne Vorrüstung	S	CAN	C	E	--	--	V	60	
										305 408 300 113	06/14-11/19 für Fzg. ohne Vorrüstung	S	CAN	C	E	D	L	V	60	
Audi A3 Sportback, 5-Türer (8V) für Fzg. ohne Vorrüstung auch für Fzg. ab 07/16- Achtung: Je nach Motorvariante können Änderungen am Kühlsystem des Fahrzeugs notwendig sein.	02/13-11/19	KIT		305 418 900 113		60	20.9	10.3	85	2000	im KIT enthalten 305 438 300 113	inkl. WLC 2.0 für Fzg. ohne Vorrüstung	S	CAN	C	E	D	L1	V	90













Audi

Audi A3 Sportback, 5-Türer für Fzg. ohne Vorrüstung Spoiler inkl. Abdeckklappe bitte beim Audi-Händler bestellen. Achtung: Je nach Motorvariante können Änderungen am Kühlsystem des Fahrzeugs notwendig sein.	06/14-06/16	KIT		305 409 900 113		60	21.0	10.3	85	2000		im KIT enthalten 305 408 300 113		06/14-11/19 für Fzg. ohne Vorrüstung	S	CAN	C	E	D	L	V	60	
Audi A3 Sportback, 5-Türer für Fzg. mit Vorrüstung Spoiler inkl. Abdeckklappe bitte beim Audi-Händler bestellen. Achtung: Je nach Motorvariante können Änderungen am Kühlsystem des Fahrzeugs notwendig sein.	06/14-06/16	KIT		317 155 900 113		60	20.5	10.3	85	2000		im KIT enthalten 305 407 300 113		06/14- für Fzg. mit Vorrüstung	S	CAN	C	E	D	L	H	30	
Audi A3 Sportback, 5-Türer (8V) für Fzg. ohne Vorrüstung auch für Fzg. ab 07/16- Achtung: Je nach Motorvariante können Änderungen am Kühlsystem des Fahrzeugs notwendig sein.	06/14-11/19	KIT		305 408 900 113		60	19.0	10.3	85	2000		im KIT enthalten 305 408 300 113		06/14-11/19 für Fzg. ohne Vorrüstung	S	CAN	C	E	D	L	V	60	
Audi A3 Sportback, 5-Türer (8V) für Fzg. mit Vorrüstung auch für Fzg. ab 07/16- Achtung: Je nach Motorvariante können Änderungen am Kühlsystem des Fahrzeugs notwendig sein.	06/14-11/19	KIT		317 154 900 113		60	20.5	10.3	85	2000		im KIT enthalten 305 407 300 113		06/14- für Fzg. mit Vorrüstung	S	CAN	C	E	D	L	H	30	
Audi A3 Sportback, 5-Türer (8V) Achtung: Je nach Motorvariante können Änderungen am Kühlsystem des Fahrzeugs notwendig sein.	07/16-11/19		 	305 605 600 001 305 606 600 001	 	60	19.4	9.0	109	2100		305 407 300 113 305 408 300 107 305 408 300 113	→	06/14- für Fzg. mit Vorrüstung 06/14-11/19 für Fzg. ohne Vorrüstung 06/14-11/19 für Fzg. ohne Vorrüstung	S	CAN	C	E	D	L	H	30	60
Audi A3 Sportback, 5-Türer (8V) für Fzg. ohne Vorrüstung Achtung: Je nach Motorvariante können Änderungen am Kühlsystem des Fahrzeugs notwendig sein.	07/16-11/19	KIT		305 555 900 113		60	19.4	9.0	109	2100		im KIT enthalten 305 408 300 113		06/14-11/19 für Fzg. ohne Vorrüstung	S	CAN	C	E	D	L	V	60	























Audi A3 Sportback, 5-Türer (8V) für Fzg. mit Vorrüstung Achtung: Je nach Motorvariante können Änderungen am Kühlsystem des Fahrzeugs notwendig sein.	07/16-11/19	KIT		305 556 900 113		60	19.4	9.0	109	2100		im KIT enthalten 305 407 300 113	06/14- für Fzg. mit Vorrüstung	S	CAN	C	E	D	L	H	30
Audi A3, 3-Türer Frontantrieb auch für Quattro, auch für S3 04/06-, auch für V6 3,2 l, 250 PS S3-Modelle 04/08-: Bitte prüfen, ob das Fzg. für den Anhängerbetrieb zugelassen ist.	05/03-04/12			321 865 600 001		60	17.0	9.4	100	1800		305 256 300 113		S	CAN	C	E	D1	--	V	120
		KIT		305 389 900 113		60	19.0	9.4	100	1800		im KIT enthalten 305 256 300 113		S	CAN	C	E	D1	--	V	120
Audi A3, 3-Türer Frontantrieb auch für Quattro, auch für S-Line und S3 04/06-, auch für V6 3,2 l, 250 PS S3-Modelle 04/08-: Bitte prüfen, ob das Fzg. für den Anhängerbetrieb zugelassen ist. Spoiler inkl. Klappe bitte beim Audi-Händler bestellen.	05/03-04/12			321 885 600 001		60	17.0	9.4	100	1800		305 256 300 113		S	CAN	C	E	D1	--	V	120
		KIT		305 390 900 113		60	19.0	9.4	100	1800		im KIT enthalten 305 256 300 113		S	CAN	C	E	D1	--	V	120
Audi A3, 3-Türer für Fzg. ohne Vorrüstung auch für S-Line, nicht für S3 Achtung: Je nach Motorvariante können Änderungen am Kühlsystem des Fahrzeugs notwendig sein.	05/12-06/14	KIT		317 131 900 113		60	21.0	10.3	85	2000		im KIT enthalten 305 406 300 113	-06/14 für Fzg. ohne Vorrüstung	S	CAN	C	E	D	L1	V	150
Audi A3, 3-Türer für Fzg. ohne Vorrüstung Spoiler inkl. Abdeckklappe bitte beim Audi-Händler bestellen. auch für S-Line, nicht für S3 Achtung: Je nach Motorvariante können Änderungen am Kühlsystem des Fahrzeugs notwendig sein.	05/12-06/14	KIT		317 132 900 113		60	21.0	10.3	85	2000		im KIT enthalten 305 406 300 113	-06/14 für Fzg. ohne Vorrüstung	S	CAN	C	E	D	L1	V	150





















Audi

Audi A3, 3-Türer auch für S-Line, nicht für S3 auch für Facelift 07/16- Achtung: Je nach Motorvariante können Änderungen am Kühlsystem des Fahrzeugs notwendig sein.	05/12-11/19		317 131 600 001		60	19.0	10.3	85	2000	305 403 300 113	-06/14 für Fzg. mit Vorrüstung	S	CAN	C	E	D	L1	H	45	
										305 406 300 113	-06/14 für Fzg. ohne Vorrüstung	S	CAN	C	E	D	L1	V	150	
										305 407 300 113	06/14-11/19 für Fzg. mit Vorrüstung	S	CAN	C	E	D	L	H	30	
										305 408 300 107	→ 06/14- für Fzg. ohne Vorrüstung	S	CAN	C	E	--	--	V	60	
										305 408 300 113	06/14- für Fzg. ohne Vorrüstung	S	CAN	C	E	D	L	V	60	
Audi A3, 3-Türer auch für S-Line, nicht für S3 auch für Facelift 07/16- Spoiler inkl. Abdeckklappe bitte beim Audi-Händler bestellen. Achtung: Je nach Motorvariante können Änderungen am Kühlsystem des Fahrzeugs notwendig sein.	05/12-11/19		317 132 600 001		60	19.0	10.3	85	2000	305 403 300 113	-06/14 für Fzg. mit Vorrüstung	S	CAN	C	E	D	L1	H	45	
										305 406 300 113	-06/14 für Fzg. ohne Vorrüstung	S	CAN	C	E	D	L1	V	150	
										305 407 300 113	06/14-11/19 für Fzg. mit Vorrüstung	S	CAN	C	E	D	L	H	30	
										305 408 300 107	→ 06/14- für Fzg. ohne Vorrüstung	S	CAN	C	E	--	--	V	60	
										305 408 300 113	06/14- für Fzg. ohne Vorrüstung	S	CAN	C	E	D	L	V	60	
Audi A3, 3-Türer für Fzg. ohne Vorrüstung auch für S-Line, nicht für S3 auch für Facelift 07/16- Achtung: Je nach Motorvariante können Änderungen am Kühlsystem des Fahrzeugs notwendig sein.	05/12-11/19	KIT		305 418 900 113		60	20.9	10.3	85	2000	im KIT enthalten 305 438 300 113	inkl. WLC 2.0 für Fzg. ohne Vorrüstung	S	CAN	C	E	D	L1	V	90
Audi A3, 3-Türer für Fzg. ohne Vorrüstung Spoiler inkl. Abdeckklappe bitte beim Audi-Händler bestellen. auch für S-Line, nicht für S3 Achtung: Je nach Motorvariante können Änderungen am Kühlsystem des Fahrzeugs notwendig sein.	05/12-11/19	KIT		305 419 900 113		60	20.9	10.3	85	2000	im KIT enthalten 305 438 300 113	inkl. WLC 2.0 für Fzg. ohne Vorrüstung	S	CAN	C	E	D	L1	V	90



















Audi A3, 3-Türer für Fzg. ohne Vorrüstung Spoiler inkl. Abdeckklappe bitte beim Audi-Händler bestellen. auch für S-Line, nicht für S3 Achtung: Je nach Motorvariante können Änderungen am Kühlsystem des Fahrzeugs notwendig sein.	06/14-05/16	KIT		305 409 900 113		60	21.0	10.3	85	2000		im KIT enthalten 305 408 300 113	06/14- für Fzg. ohne Vorrüstung	S	CAN	C	E	D	L	V	60
Audi A3, 3-Türer für Fzg. mit Vorrüstung Spoiler inkl. Abdeckklappe bitte beim Audi-Händler bestellen. auch für S-Line, nicht für S3 Achtung: Je nach Motorvariante können Änderungen am Kühlsystem des Fahrzeugs notwendig sein.	06/14-05/16	KIT		317 155 900 113		60	20.5	10.3	85	2000		im KIT enthalten 305 407 300 113	06/14-11/19 für Fzg. mit Vorrüstung	S	CAN	C	E	D	L	H	30
Audi A3, 3-Türer für Fzg. ohne Vorrüstung auch für S-Line, nicht für S3 auch für Facelift 07/16- Achtung: Je nach Motorvariante können Änderungen am Kühlsystem des Fahrzeugs notwendig sein.	06/14-11/19	KIT		305 408 900 113		60	19.0	10.3	85	2000		im KIT enthalten 305 408 300 113	06/14- für Fzg. ohne Vorrüstung	S	CAN	C	E	D	L	V	60
Audi A3, 3-Türer für Fzg. mit Vorrüstung auch für S-Line, nicht für S3 auch für Facelift 07/16- Achtung: Je nach Motorvariante können Änderungen am Kühlsystem des Fahrzeugs notwendig sein.	06/14-11/19	KIT		317 154 900 113		60	20.5	10.3	85	2000		im KIT enthalten 305 407 300 113	06/14-11/19 für Fzg. mit Vorrüstung	S	CAN	C	E	D	L	H	30
Audi A4 Allroad Quattro B8 Achtung: Je nach Motorvariante können Änderungen am Kühlsystem des Fahrzeugs notwendig sein. AUFNAHMEROHR FÜR KUGELSTANGE SICHTBAR	06/09-12/15			305 571 600 001		90	25.1	11.1	90	2100		305 214 300 113		S	CAN	C	E	D	L1	H	60
		KIT		305 571 900 113		90	26.8	11.1	90	2100		im KIT enthalten 305 214 300 113		S	CAN	C	E	D	L1	H	60



























Audi

Audi A4 Allroad Quattro B9	01/16-		305 450 600 001		90	24.0	11.2	85	2100		305 417 300 113 →		S	A	C1	E2	D	L1	H	60	
			305 447 600 001		90	25.5	11.2	85	2100		305 437 300 113		S	CAN	C	E	D	L	H	60	
											305 447 300 113		S	CAN	C	E	D	L1	H	60	
		KIT		305 450 900 113 →		90	28.0	11.2	85	2100		im KIT enthalten 305 417 300 113 →		S	A	C1	E2	D	L1	H	60
		KIT		305 531 900 113		90	25.1	11.2	85	2100		im KIT enthalten 305 437 300 113		S	CAN	C	E	D	L	H	60
		KIT		305 447 900 113 →		90	29.0	11.2	85	2100		im KIT enthalten 305 417 300 113 →		S	A	C1	E2	D	L1	H	60
		KIT		305 532 900 113		90	26.6	11.2	85	2100		im KIT enthalten 305 437 300 113		S	CAN	C	E	D	L	H	60
		Audi A4 Avant auch für Quattro + S4 nicht für RS4	01/96-11/01		305 179 600 001		150	18.0	10.1	75	1800										
Audi A4 Avant B6 Quattro und S-Line, nicht für S4	11/01-11/04		305 205 600 001		120	18.5	10.3	85	2000		305 215 300 113		S	CAN	C	E	D1	--	H	75	
			305 206 600 001		120	20.0	10.3	85	2000												
		KIT		305 205 900 113		120	20.5	10.3	85	2000		im KIT enthalten 305 215 300 113		S	CAN	C	E	D1	--	H	75
		KIT		305 206 900 113		120	22.0	10.3	85	2000		im KIT enthalten 305 215 300 113		S	CAN	C	E	D1	--	H	75























Audi A4 Avant B7 auch für Quattro, S-Line nicht für RS4/S4	11/04-05/08		305 301 600 001		120	20.0	10.4	100	2000	305 210 300 113	S	CAN	C	E	D1	L1	V	105	
			305 302 600 001		120	20.0	10.4	100	2000										
	KIT		305 301 900 113		120	22.0	10.4	100	2000	im KIT enthalten 305 210 300 113	S	CAN	C	E	D1	L1	V	105	
	KIT		305 302 900 113		120	22.0	10.4	100	2000	im KIT enthalten 305 210 300 113	S	CAN	C	E	D1	L1	V	105	
Audi A4 Avant B8 auch für S4, S-Line, Quattro nicht für RS Achtung: Je nach Motorvariante können Änderungen am Kühlsystem des Fahrzeugs notwendig sein.	04/08-11/15		305 443 600 001		90	19.0	11.1	90	2000	305 214 300 113	S	CAN	C	E	D	L1	H	60	
			305 571 300 113		90	19.0	11.1	90	2000	04/08-12/15 B8 nur für Fzg. ohne ACC inkl. WLC 2.0									S
		KIT		305 324 900 113		90	21.0	11.1	90	2000	im KIT enthalten 305 214 300 113	S	CAN	C	E	D	L1	H	60
Audi A4 Avant B8 auch für S4, S-Line, Quattro Sport nicht für RS Bei Montage an S4 bitte längeren Steckdosenhalter, Art.-Nr. 921740650001 bestellen. Achtung: Je nach Motorvariante können Änderungen am Kühlsystem des Fahrzeugs notwendig sein. AUFNAHMEROHR FÜR KUGELSTANGE SICHTBAR	04/08-11/15		305 571 600 001		90	25.1	11.1	90	2100	305 214 300 113	S	CAN	C	E	D	L1	H	60	
			305 571 300 113		90	25.1	11.1	90	2100	04/08-12/15 B8 nur für Fzg. ohne ACC inkl. WLC 2.0									S
		KIT		305 571 900 113		90	26.8	11.1	90	2100	im KIT enthalten 305 214 300 113	S	CAN	C	E	D	L1	H	60





















Audi

Audi A4 Avant B9 nicht für CNG nicht für RS4	05/15-			305 450 600 001		90	24.0	11.2	85	2100		305 417 300 113	→		S	A	C1	E2	D	L1	H	60			
				305 447 600 001		90	25.5	11.2	85	2100		305 437 300 113			S	CAN	C	E	D	L	H	60			
												305 447 300 113			S	CAN	C	E	D	L1	H	60			
		KIT		305 450 900 113	→		90	28.0	11.2	85	2100		im KIT enthalten 305 417 300 113	→		S	A	C1	E2	D	L1	H	60		
		KIT		305 531 900 113			90	25.1	11.2	85	2100		im KIT enthalten 305 437 300 113			S	CAN	C	E	D	L	H	60		
Audi A4 Avant B9 für Fahrzeuge ohne Vorrüstung nicht für S-Line 05/19- nicht für CNG auch für AdBlue	05/15-	KIT		305 627 900 113		90		10.7	90	2100		im KIT enthalten 300 001 300 153		nicht einzeln lieferbar	S	CAN	C	E	D	L1	H	60			
		Audi A4 Cabrio B6, nicht für S4	05/02-05			305 205 600 001		120	18.5	10.3	85	2000		305 215 300 113			S	CAN	C	E	D1	--	H	75	
				KIT		305 205 900 113			120	20.5	10.3	85	2000		im KIT enthalten 305 215 300 113			S	CAN	C	E	D1	--	H	75
				Audi A4 Cabrio B6 auch für S-Line, nicht für S4	05/02-05			305 206 600 001		120	20.0	10.3	85	2000		305 215 300 113			S	CAN	C	E	D1	--	H
KIT		305 206 900 113					120	22.0	10.3	85	2000		im KIT enthalten 305 215 300 113			S	CAN	C	E	D1	--	H	75		

























Audi A4 Cabrio B7 auch für S-Line nicht für RS4/S4	10/05-03/09			305 301 600 001		120	20.0	10.4	100	2000		305 210 300 113				S	CAN	C	E	D1	L1	V	105	
				305 302 600 001		120	20.0	10.4	100	2000														
		KIT		305 301 900 113		120	22.0	10.4	100	2000	im KIT enthalten 305 210 300 113						S	CAN	C	E	D1	L1	V	105
		KIT		305 302 900 113		120	22.0	10.4	100	2000	im KIT enthalten 305 210 300 113						S	CAN	C	E	D1	L1	V	105
Audi A4 Limousine B5 auch für Quattro + S4	11/94-11/00			305 179 600 001		150	18.0	10.1	75	1800		300 078 300 113	03/99-	--	FRE	--	--	D1	L1	V				
Audi A4 Limousine B6 Quattro und S-Line, nicht für S4	11/00-11/04			305 205 600 001		120	18.5	10.3	85	2000		305 215 300 113				S	CAN	C	E	D1	--	H	75	
				305 206 600 001		120	20.0	10.3	85	2000														
		KIT		305 205 900 113		120	20.5	10.3	85	2000	im KIT enthalten 305 215 300 113						S	CAN	C	E	D1	--	H	75
		KIT		305 206 900 113		120	22.0	10.3	85	2000	im KIT enthalten 305 215 300 113						S	CAN	C	E	D1	--	H	75
Audi A4 Limousine B7 auch für Quattro, S-Line nicht für RS4/S4	11/04-09/07			305 301 600 001		120	20.0	10.4	100	2000		305 210 300 113				S	CAN	C	E	D1	L1	V	105	
				305 302 600 001		120	20.0	10.4	100	2000														
		KIT		305 301 900 113		120	22.0	10.4	100	2000	im KIT enthalten 305 210 300 113						S	CAN	C	E	D1	L1	V	105
		KIT		305 302 900 113		120	22.0	10.4	100	2000	im KIT enthalten 305 210 300 113						S	CAN	C	E	D1	L1	V	105























Audi

Audi A4 Limousine B8 auch für S4, S-Line, Quattro nicht für RS Achtung: Je nach Motorvariante können Änderungen am Kühlsystem des Fahrzeugs notwendig sein.	09/07-11/15		305 443 600 001		90	19.0	11.1	90	2000		305 214 300 113		09/07-12/15 B8 nur für Fzg. ohne ACC inkl. WLC 2.0	S	CAN	C	E	D	L1	H	60		
		KIT		305 324 900 113		90	21.0	11.1	90	2000		im KIT enthalten 305 214 300 113			S	CAN	C	E	D	L1	H	60	
Audi A4 Limousine B8 auch für S4, S-Line, Quattro Sport nicht für RS Bei Montage an S4 bitte längeren Steckdosenhalter, Art.-Nr. 905323608001 bestellen. Achtung: Je nach Motorvariante können Änderungen am Kühlsystem des Fahrzeugs notwendig sein. AUFNAHMEROHR FÜR KUGELSTANGE SICHTBAR	09/07-11/15		305 571 600 001		90	25.1	11.1	90	2100		305 214 300 113		09/07-12/15 B8 nur für Fzg. ohne ACC inkl. WLC 2.0	S	CAN	C	E	D	L1	H	60		
		KIT		305 571 900 113		90	26.8	11.1	90	2100		im KIT enthalten 305 214 300 113			S	CAN	C	E	D	L1	H	60	
Audi A4 Limousine B9 nicht für CNG	05/15-		305 450 600 001		90	24.0	11.2	85	2100		305 417 300 113	→		S	A	C1	E2	D	L1	H	60		
			305 447 600 001		90	25.5	11.2	85	2100		305 437 300 113			S	CAN	C	E	D	L	H	60		
				305 447 300 113											S	CAN	C	E	D	L1	H	60	
		KIT		305 450 900 113	→		90	28.0	11.2	85	2100		im KIT enthalten 305 417 300 113	→		S	A	C1	E2	D	L1	H	60
		KIT		305 531 900 113			90	25.1	11.2	85	2100		im KIT enthalten 305 437 300 113			S	CAN	C	E	D	L	H	60
		KIT		305 447 900 113	→		90	29.0	11.2	85	2100		im KIT enthalten 305 417 300 113	→		S	A	C1	E2	D	L1	H	60
KIT		305 532 900 113			90	26.6	11.2	85	2100		im KIT enthalten 305 437 300 113			S	CAN	C	E	D	L	H	60		
Audi A4 Limousine B9 für Fahrzeuge ohne Vorrüstung nicht für S-Line 05/19- nicht für CNG auch für AdBlue	05/15-	KIT		305 627 900 113		90		10.7	90	2100		im KIT enthalten 300 001 300 153	nicht einzeln lieferbar	S	CAN	C	E	D	L1	H	60		





























Audi A5 Cabrio B8 auch für S5, S-Line, Quattro nicht für RS Achtung: Je nach Motorvariante können Änderungen am Kühlsystem des Fahrzeugs notwendig sein.	09-09/16		305 443 600 001		90	19.0	11.1	90	2000		305 214 300 113		03/09-03/17 B8 nur für Fzg. ohne ACC inkl. WLC 2.0	S	CAN	C	E	D	L1	H	60	
												305 571 300 113			S	CAN	C	E	D	L1	H	45
Audi A5 Cabrio B8 auch für S5, S-Line, Quattro nicht für RS Bei Montage an S5 bitte längeren Steckdosenhalter, Art.-Nr. 905323608001 bestellen. Achtung: Je nach Motorvariante können Änderungen am Kühlsystem des Fahrzeugs notwendig sein. AUFNAHMEROHR FÜR KUGELSTANGE SICHTBAR	09-09/16		305 571 600 001		90	25.1	11.1	90	2100		305 214 300 113		03/09-03/17 B8 nur für Fzg. ohne ACC inkl. WLC 2.0	S	CAN	C	E	D	L1	H	60	
		KIT		305 571 900 113		90	26.8	11.1	90	2100		im KIT enthalten 305 214 300 113			S	CAN	C	E	D	L1	H	60
Audi A5 Cabrio (F57) nicht für CNG	09/16-		305 450 600 001		90	24.0	11.2	85	2100		305 417 300 113	→		S	A	C1	E2	D	L1	H	60	
				305 447 600 001		90	25.5	11.2	85	2100		305 437 300 113			S	CAN	C	E	D	L	H	60
											305 447 300 113			S	CAN	C	E	D	L1	H	60	
		KIT		305 450 900 113	→ 	90	28.0	11.2	85	2100		im KIT enthalten 305 417 300 113	→		S	A	C1	E2	D	L1	H	60
		KIT		305 531 900 113		90	25.1	11.2	85	2100		im KIT enthalten 305 437 300 113			S	CAN	C	E	D	L	H	60
		KIT		305 447 900 113	→ 	90	29.0	11.2	85	2100		im KIT enthalten 305 417 300 113	→		S	A	C1	E2	D	L1	H	60
Audi A5 Coupé B8 auch für S5, S-Line, Quattro nicht für RS Achtung: Je nach Motorvariante können Änderungen am Kühlsystem des Fahrzeugs notwendig sein.	06/07-09/16		305 443 600 001		90	19.0	11.1	90	2000		305 214 300 113		06/07-10/16 B8 nur für Fzg. ohne ACC inkl. WLC 2.0	S	CAN	C	E	D	L1	H	60	
											305 571 300 113			S	CAN	C	E	D	L1	H	45	
		KIT		305 324 900 113		90	21.0	11.1	90	2000		im KIT enthalten 305 214 300 113			S	CAN	C	E	D	L1	H	60

























Audi

Audi A5 Coupé B8 auch für S5, S-Line, Quattro Sport nicht für RS Bei Montage an S5 bitte längeren Steckdosenhalter, Art.-Nr. 905323608001 bestellen. Achtung: Je nach Motorvariante können Änderungen am Kühlsystem des Fahrzeugs notwendig sein. AUFNAHMEROHR FÜR KUGELSTANGE SICHTBAR	06/07-09/16		305 571 600 001		90	25.1	11.1	90	2100	305 214 300 113	06/07-10/16 B8 nur für Fzg. ohne ACC inkl. WLC 2.0	S	CAN	C	E	D	L1	H	60	
		KIT		305 571 900 113		90	26.8	11.1	90	2100		im KIT enthalten 305 214 300 113	S	CAN	C	E	D	L1	H	60
Audi A5 Coupé B9 nicht für CNG nicht für RS5	09/16-		305 450 600 001		90	24.0	11.2	85	2100	305 417 300 113	→	S	A	C1	E2	D	L1	H	60	
			305 447 600 001		90	25.5	11.2	85	2100	305 437 300 113		S	CAN	C	E	D	L	H	60	
			305 447 300 113		90	25.5	11.2	85	2100	305 447 300 113		S	CAN	C	E	D	L1	H	60	
		KIT		305 450 900 113	→ 	90	28.0	11.2	85	2100	im KIT enthalten 305 417 300 113	→	S	A	C1	E2	D	L1	H	60
		KIT		305 531 900 113		90	25.1	11.2	85	2100	im KIT enthalten 305 437 300 113		S	CAN	C	E	D	L	H	60
		KIT		305 447 900 113	→ 	90	29.0	11.2	85	2100	im KIT enthalten 305 417 300 113	→	S	A	C1	E2	D	L1	H	60
KIT		305 532 900 113		90	26.6	11.2	85	2100	im KIT enthalten 305 437 300 113		S	CAN	C	E	D	L	H	60		
Audi A5 Sportback B8 auch für S5, S-Line, Quattro nicht für RS Achtung: Je nach Motorvariante können Änderungen am Kühlsystem des Fahrzeugs notwendig sein.	09/09-04/17		305 443 600 001		90	19.0	11.1	90	2000	305 214 300 113	09/09-01/17 B8 nur für Fzg. ohne ACC inkl. WLC 2.0	S	CAN	C	E	D	L1	H	60	
			305 571 300 113		90	19.0	11.1	90	2000	305 571 300 113		S	CAN	C	E	D	L1	H	45	
		KIT		305 324 900 113		90	21.0	11.1	90	2000	im KIT enthalten 305 214 300 113		S	CAN	C	E	D	L1	H	60

























Audi A5 Sportback B8 auch für S5, S-Line, Quattro Sport nicht für RS Bei Montage an S5 bitte längeren Steckdosenhalter, Art.-Nr. 905323608001 bestellen. Achtung: Je nach Motorvariante können Änderungen am Kühlsystem des Fahrzeugs notwendig sein. AUFNAHMEROHR FÜR KUGELSTANGE SICHTBAR	09/09-04/17			305 571 600 001		90	25.1	11.1	90	2100		305 214 300 113		09/09-01/17 B8 nur für Fzg. ohne ACC inkl. WLC 2.0	S	CAN	C	E	D	L1	H	60		
													305 571 300 113			S	CAN	C	E	D	L1	H	45	
		KIT		305 571 900 113		90	26.8	11.1	90	2100		im KIT enthalten 305 214 300 113			S	CAN	C	E	D	L1	H	60		
Audi A5 Sportback B9 nicht für CNG nicht für RS5	05/17-			305 450 600 001		90	24.0	11.2	85	2100		305 417 300 113	→		S	A	C1	E2	D	L1	H	60		
					305 447 600 001		90	25.5	11.2	85	2100		305 437 300 113			S	CAN	C	E	D	L	H	60	
						305 447 600 001		90	25.5	11.2	85	2100		305 447 300 113			S	CAN	C	E	D	L1	H	60
		KIT		305 450 900 113	→		90	28.0	11.2	85	2100		im KIT enthalten 305 417 300 113	→		S	A	C1	E2	D	L1	H	60	
		KIT		305 531 900 113			90	25.1	11.2	85	2100		im KIT enthalten 305 437 300 113			S	CAN	C	E	D	L	H	60	
		KIT		305 447 900 113	→		90	29.0	11.2	85	2100		im KIT enthalten 305 417 300 113	→		S	A	C1	E2	D	L1	H	60	
		KIT		305 532 900 113		90	26.6	11.2	85	2100		im KIT enthalten 305 437 300 113			S	CAN	C	E	D	L	H	60		
Audi A6 Allroad C7 Bitte Spoiler beim Audi-Händler bestellen.	06/12-10/14	KIT		305 407 900 113		90	22.0	12.6	100	2500		im KIT enthalten 305 385 300 113		-10/14	S	CAN	C	E	D	L1	H	45		
Audi A6 Allroad C7 Bitte Spoiler beim Audi-Händler bestellen.	06/12-09/18			305 407 600 001		90	20.0	12.6	100	2500		305 385 300 113		-10/14	S	CAN	C	E	D	L1	H	45		
				305 407 600 001		90	20.0	12.6	100	2500		305 387 300 113		10/14-	S	CAN	C	E	D	L	H	60		
Audi A6 Allroad (C8) auch für AdBlue	10/18-			305 601 600 001		90	26.1	12.6	150	2500		305 486 300 113			S	CAN	C	E	D	L	H	90		
													305 601 300 113			S	CAN	C	E	D	L1	H	45	
		KIT		305 601 900 113		90	27.9	12.6	150	2500		im KIT enthalten 305 486 300 113			S	CAN	C	E	D	L	H	90		





























Audi

Audi A6 Allroad C8 auch für AdBlue	10/18-	KIT		305 613 900 113		90	31.0	12.6	150	2500		im KIT enthalten 300 007 300 153	nicht einzeln lieferbar	S	CAN	--	E1	D	L1	H	60
Audi A6 Avant mit Stahlfederung auch für S6 und Quattro, nicht für RS6, nicht für S-Line	03/05-09/11			305 564 600 001		60	25.8	12.0	90	2200		305 268 300 113		S	CAN	C	E	D	L1	H	45
				305 565 600 001		60	25.8	12.0	90	2400											
		KIT		305 269 900 113		120	27.0	12.0	90	2200		im KIT enthalten 305 268 300 113		S	CAN	C	E	D	L1	H	45
		KIT		305 565 900 113		60	27.6	12.0	90	2400		im KIT enthalten 305 268 300 113		S	CAN	C	E	D	L1	H	45
Audi A6 Avant nicht für RS6 auch für Quattro, S-Line	09/11-10/14	KIT		305 428 900 113		90	22.0	12.6	100	2500		im KIT enthalten 305 385 300 113	-10/14	S	CAN	C	E	D	L1	H	45
Audi A6 Avant nicht für RS6 auch für Quattro, S-Line	09/11-10/14	KIT		305 429 900 113		90	23.0	12.6	100	2500		im KIT enthalten 305 385 300 113	-10/14	S	CAN	C	E	D	L1	H	45
Audi A6 Avant nicht für RS6 auch für Quattro, S-Line	09/11-08/18			305 428 600 001		90	20.0	12.6	100	2500		305 385 300 113	-10/14	S	CAN	C	E	D	L1	H	45
				305 429 600 001		90	21.0	12.6	100	2500		305 387 300 113	10/14-08/18	S	CAN	C	E	D	L	H	60
Audi A6 Avant nicht für RS6 auch für Quattro, S-Line	10/14-08/18	KIT		305 438 900 113		90	22.0	12.6	100	2500		im KIT enthalten 305 387 300 113	10/14-08/18	S	CAN	C	E	D	L	H	60
		KIT		305 439 900 113		90	23.0	12.6	100	2500		im KIT enthalten 305 387 300 113	10/14-08/18	S	CAN	C	E	D	L	H	60
Audi A6 Avant C8 auch für AdBlue nicht für RS6	05/18-	KIT		305 557 900 113		90	22.6	12.6	150	2500		im KIT enthalten 305 486 300 113	05/18-	S	CAN	C	E	D	L	H	90
		KIT		305 558 900 113		90	25.2	12.6	150	2500		im KIT enthalten 305 486 300 113	05/18-	S	CAN	C	E	D	L	H	90
Audi A6 Avant (C8) auch für AdBlue nicht für RS6	05/18-			305 602 600 001		90	23.6	12.6	150	2500		305 486 300 113	05/18-	S	CAN	C	E	D	L	H	90
												305 601 300 113		S	CAN	C	E	D	L1	H	45

Audi A6 Avant (C8) auch für AdBlue nicht für RS6	05/18-			305 603 600 001		90	26.3	12.6	150	2500		305 486 300 113	05/18-	S	CAN	C	E	D	L	H	90											
												305 601 300 113		S	CAN	C	E	D	L1	H	45											
Audi A6 Avant C8 auch für AdBlue nicht für RS	05/18-	KIT		305 613 900 113		90	31.0	12.6	150	2500		im KIT enthalten 300 007 300 153	nicht einzeln lieferbar	S	CAN	--	E1	D	L1	H	60											
Audi A6 Limousine mit Stahlfederung auch für S6 und Quattro, nicht für RS6, nicht für S-Line	04/04-03/11			305 565 600 001		60	25.8	12.0	90	2400		305 268 300 113		S	CAN	C	E	D	L1	H	45											
														KIT		305 269 900 113		120	27.0	12.0	90	2200		im KIT enthalten 305 268 300 113	S	CAN	C	E	D	L1	H	45
														KIT		305 565 900 113		60	27.6	12.0	90	2400		im KIT enthalten 305 268 300 113	S	CAN	C	E	D	L1	H	45
Audi A6 Limousine mit Stahlfederung auch für S6 und Quattro, nicht für RS6, nicht für S-Line	03/05-09/11			305 564 600 001		60	25.8	12.0	90	2200		305 268 300 113		S	CAN	C	E	D	L1	H	45											
Audi A6 Limousine	03/11-10/14	KIT		305 428 900 113		90	22.0	12.6	100	2500		im KIT enthalten 305 385 300 113	-10/14	S	CAN	C	E	D	L1	H	45											
													KIT		305 429 900 113		90	23.0	12.6	100	2500		im KIT enthalten 305 385 300 113	-10/14	S	CAN	C	E	D	L1	H	45
Audi A6 Limousine	03/11-02/18			305 428 600 001		90	20.0	12.6	100	2500		305 385 300 113	-10/14	S	CAN	C	E	D	L1	H	45											
														305 429 600 001		90	21.0	12.6	100	2500		305 387 300 113	10/14-02/18	S	CAN	C	E	D	L	H	60	
Audi A6 Limousine	10/14-02/18	KIT		305 438 900 113		90	22.0	12.6	100	2500		im KIT enthalten 305 387 300 113	10/14-02/18	S	CAN	C	E	D	L	H	60											
													KIT		305 439 900 113		90	23.0	12.6	100	2500		im KIT enthalten 305 387 300 113	10/14-02/18	S	CAN	C	E	D	L	H	60

























Audi

























Audi A6 Limousine C8 auch für AdBlue	02/18-	KIT		305 557 900 113		90	22.6	12.6	150	2500	im KIT enthalten 305 486 300 113	02/18-	S	CAN	C	E	D	L	H	90
		KIT		305 558 900 113		90	25.2	12.6	150	2500	im KIT enthalten 305 486 300 113	02/18-	S	CAN	C	E	D	L	H	90
		KIT		305 613 900 113		90	31.0	12.6	150	2500	im KIT enthalten 300 007 300 153	nicht einzeln lieferbar	S	CAN	--	E1	D	L1	H	60
Audi A6 Limousine (C8) auch für AdBlue	02/18-			305 602 600 001		90	23.6	12.6	150	2500	305 486 300 113	02/18-	S	CAN	C	E	D	L	H	90
				305 603 600 001		90	26.3	12.6	150	2500	305 601 300 113		S	CAN	C	E	D	L1	H	45
Audi A7 Sportback auch für S-Line + S7	10/10-10/14	KIT		305 428 900 113		90	22.0	12.6	100	2500	im KIT enthalten 305 385 300 113	-10/14	S	CAN	C	E	D	L1	H	45
		KIT		305 429 900 113		90	23.0	12.6	100	2500	im KIT enthalten 305 385 300 113	-10/14	S	CAN	C	E	D	L1	H	45
Audi A7 Sportback auch für S-Line + S7	10/10-01/18			305 428 600 001		90	20.0	12.6	100	2500	305 385 300 113	-10/14	S	CAN	C	E	D	L1	H	45
				305 429 600 001		90	21.0	12.6	100	2500	305 387 300 113	10/14-01/18	S	CAN	C	E	D	L	H	60
Audi A7 Sportback auch für S-Line + S7	10/14-01/18	KIT		305 438 900 113		90	22.0	12.6	100	2500	im KIT enthalten 305 387 300 113	10/14-01/18	S	CAN	C	E	D	L	H	60
		KIT		305 439 900 113		90	23.0	12.6	100	2500	im KIT enthalten 305 387 300 113	10/14-01/18	S	CAN	C	E	D	L	H	60
Audi A7 Sportback C8 auch für AdBlue auch für Hybrid nicht für RS6	04/18-			305 602 600 001		90	23.6	12.6	150	2500	305 486 300 113		S	CAN	C	E	D	L	H	90
											305 601 300 113		S	CAN	C	E	D	L1	H	45

Audi A7 Sportback C8 auch für AdBlue auch für Hybrid nicht für RS6	04/18-			305 603 600 001		90	26.3	12.6	150	2500		305 486 300 113			S	CAN	C	E	D	L	H	90	
												305 601 300 113			S	CAN	C	E	D	L1	H	45	
		KIT		305 557 900 113		90	22.6	12.6	150	2500		im KIT enthalten 305 486 300 113			S	CAN	C	E	D	L	H	90	
		KIT		305 558 900 113		90	25.2	12.6	150	2500		im KIT enthalten 305 486 300 113			S	CAN	C	E	D	L	H	90	
Audi A8	03/10-10/17			305 384 600 001		60	26.0	12.6	100	2200		305 384 300 113	-10/13		S	CAN	C	E	D	L1	H	60	
											305 391 300 113	11/13-		S	CAN	C	E	D	L	H			
Audi E-Tron GEN auch für Sportback	09/18-11/22			305 600 600 001		75	19.3	11.4	135	1800		305 437 300 113	09/18-11/22		S	CAN	C	E	D	L	H	60	
			KIT		305 600 900 113		75	20.4	11.4	135	1800		im KIT enthalten 305 437 300 113	09/18-11/22		S	CAN	C	E	D	L	H	60
Audi Q2	11/16-			317 131 600 001		60	19.0	10.3	85	2000		305 407 300 113	für Fzg. mit Vorrüstung		S	CAN	C	E	D	L	H	30	
					317 132 600 001		60	19.0	10.3	85	2000		305 408 300 107	→ für Fzg. ohne Vorrüstung		S	CAN	C	E	--	--	V	60
												305 408 300 113	für Fzg. ohne Vorrüstung		S	CAN	C	E	D	L	V	60	
Audi Q2 für Fzg. ohne Vorrüstung	11/16-	KIT		305 408 900 113		60	19.0	10.3	85	2000		im KIT enthalten 305 408 300 113	für Fzg. ohne Vorrüstung		S	CAN	C	E	D	L	V	60	
		KIT		305 418 900 113		60	20.9	10.3	85	2000		im KIT enthalten 305 438 300 113	inkl. WLC 2.0 für Fzg. ohne Vorrüstung		S	CAN	C	E	D	L1	V	90	
		KIT		305 409 900 113		60	21.0	10.3	85	2000		im KIT enthalten 305 408 300 113	für Fzg. ohne Vorrüstung		S	CAN	C	E	D	L	V	60	
		KIT		305 419 900 113		60	20.9	10.3	85	2000		im KIT enthalten 305 438 300 113	inkl. WLC 2.0 für Fzg. ohne Vorrüstung		S	CAN	C	E	D	L1	V	90	
Audi Q2 für Fzg. mit Vorrüstung	11/16-	KIT		317 154 900 113		60	20.5	10.3	85	2000		im KIT enthalten 305 407 300 113	für Fzg. mit Vorrüstung		S	CAN	C	E	D	L	H	30	
		KIT		317 155 900 113		60	20.5	10.3	85	2000		im KIT enthalten 305 407 300 113	für Fzg. mit Vorrüstung		S	CAN	C	E	D	L	H	30	























Audi









Audi

Audi Q3 auch für S-Line, auch für Quattro RS Fahrzeuge ab Baujahr 2015- benötigen eine neue Abdeckung inkl. Ausschnitt. Bitte beim Audi-Händler bestellen.	09/11-06/18			305 421 600 001		90	19.0	12.0	100	2500		305 410 300 113	→	-06/18	S	CAN	C	E	D	L1	V	120	
				305 423 600 001		90	21.0	12.0	140	2500													
		KIT		305 421 900 113		90	21.0	12.0	100	2500		im KIT enthalten 305 410 300 113	→	-06/18	S	CAN	C	E	D	L1	V	120	
		KIT		305 423 900 113		90	23.0	12.0	140	2500		im KIT enthalten 305 410 300 113	→	-06/18	S	CAN	C	E	D	L1	V	120	
Audi Q3 F3B auch S-Line	07/18-			344 121 600 001		60	14.0	12.3	150	2500		305 407 300 113		für Fzg. mit Vorrüstung	S	CAN	C	E	D	L	H	30	
				344 120 600 001		60	16.6	12.3	150	2500		305 408 300 107	→	für Fzg. ohne Vorrüstung	S	CAN	C	E	--	--	V	60	
												305 408 300 113		für Fzg. ohne Vorrüstung	S	CAN	C	E	D	L	V	60	
Audi Q3 F3B für Fzg. ohne Vorrüstung auch S-Line	07/18-	KIT		344 121 900 113		60	16.0	12.3	150	2500		im KIT enthalten 305 438 300 113		inkl. WLC 2.0 für Fzg. ohne Vorrüstung	S	CAN	C	E	D	L1	V	90	
		KIT		344 120 900 113		60	18.5	12.3	150	2500		im KIT enthalten 305 438 300 113		inkl. WLC 2.0 für Fzg. ohne Vorrüstung	S	CAN	C	E	D	L1	V	90	
Audi Q3 F3B für Fzg. mit Vorrüstung auch S-Line	07/18-	KIT		344 071 900 113		60	15.5	12.3	150	2500		im KIT enthalten 305 407 300 113		für Fzg. mit Vorrüstung	S	CAN	C	E	D	L	H	30	
		KIT		344 070 900 113		60	18.7	12.3	150	2500		im KIT enthalten 305 407 300 113		für Fzg. mit Vorrüstung	S	CAN	C	E	D	L	H	30	
Audi Q3 Sportback F3N auch S-Line	06/19-			344 121 600 001		60	14.0	12.3	150	2500		305 407 300 113		für Fzg. mit Vorrüstung	S	CAN	C	E	D	L	H	30	
												305 408 300 107	→		S	CAN	C	E	--	--	V	60	
													305 408 300 113		für Fzg. ohne Vorrüstung	S	CAN	C	E	D	L	V	60
Audi Q3 Sportback F3N für Fzg. ohne Vorrüstung auch S-Line	06/19-	KIT		344 121 900 113		60	16.0	12.3	150	2500		im KIT enthalten 305 438 300 113		inkl. WLC 2.0 für Fzg. ohne Vorrüstung	S	CAN	C	E	D	L1	V	90	











Audi Q3 Sportback F3N für Fzg. mit Vorrüstung auch S-Line	06/19-	KIT		344 071 900 113		60	15.5	12.3	150	2500		im KIT enthalten 305 407 300 113		für Fzg. mit Vorrüstung	S	CAN	C	E	D	L	H	30	
		KIT		344 070 900 113		60	18.7	12.3	150	2500		im KIT enthalten 305 407 300 113		für Fzg. mit Vorrüstung	S	CAN	C	E	D	L	H	30	
Audi Q3 Sportback F3N auch S-Line	06/19-			344 120 600 001		60	16.6	12.3	150	2500		305 407 300 113	→	für Fzg. mit Vorrüstung	S	CAN	C	E	D	L	H	30	
											305 408 300 107	S		CAN	C	E	--	--	V	60			
												305 408 300 113		S	CAN	C	E	D	L	V	60		
Audi Q3 Sportback F3N für Fzg. ohne Vorrüstung auch S-Line	06/19-	KIT		344 120 900 113		60	18.5	12.3	150	2500		im KIT enthalten 305 438 300 113		inkl. WLC 2.0 für Fzg. ohne Vorrüstung	S	CAN	C	E	D	L1	V	90	
Audi Q5 auch für S-Line, auch für SQ5 Achtung: Je nach Motorvariante können Änderungen am Kühlsystem des Fahrzeugs notwendig sein.	10/08-05/16			305 411 600 001		90	21.0	12.1	100	2400		305 216 300 113			S	CAN	C	E	D	L1	H	60	
				327 068 600 001		90	21.0	12.1	100	2400													
		KIT		305 351 900 113		90	23.0	12.1	100	2400		im KIT enthalten 305 216 300 113			S	CAN	C	E	D	L1	H	60	
		KIT		305 412 900 113		90	26.0	12.1	100	2400		im KIT enthalten 305 216 300 113			S	CAN	C	E	D	L1	H	60	
Audi Q5 (FYG,FYB) auch für SQ5 auch für Plugin Hybrid	06/16-			305 579 600 001		60	20.3	12.3	150	2400		305 437 300 113		auch für Hybrid	S	CAN	C	E	D	L	H	60	
				305 580 600 001		60	23.0	12.3	150	2400		305 447 300 113			S	CAN	C	E	D	L1	H	60	
		KIT		305 579 900 113		60	21.9	12.3	150	2400		im KIT enthalten 305 437 300 113		auch für Hybrid	S	CAN	C	E	D	L	H	60	
		KIT		305 580 900 113		60	24.6	12.3	150	2400		im KIT enthalten 305 437 300 113		auch für Hybrid	S	CAN	C	E	D	L	H	60	







Audi

Audi Q5 Sportback (FYT) auch für SQ5 auch für S-Line auch für Plugin Hybrid auch für AdBlue	10/20-			305 579 600 001		60	20.3	12.3	150	2400		305 437 300 113	10/20-	S	CAN	C	E	D	L	H	60		
				305 580 600 001		60	23.0	12.3	150	2400		305 447 300 113		S	CAN	C	E	D	L1	H	60		
		KIT		305 579 900 113		60	21.9	12.3	150	2400		im KIT enthalten 305 437 300 113		10/20-	S	CAN	C	E	D	L	H	60	
		KIT		305 580 900 113		60	24.6	12.3	150	2400		im KIT enthalten 305 437 300 113		10/20-	S	CAN	C	E	D	L	H	60	
Audi Q7 auch für S-Line Spoiler bitte beim Audi-Händler bestellen.	01/06-07/15			305 415 600 001		120	34.0	16.4	140	3500		305 500 300 001	→	Erweiterungssatz für Kfz. ohne elektrische Heckklappe									
												305 500 300 113		S	CAN	C	E	D	L1	H	60		
		KIT		305 314 900 113		120	36.0	16.4	140	3500		im KIT enthalten 305 500 300 113	für Fahrzeuge mit elektrischer Heckklappe	S	CAN	C	E	D	L1	H	60		
Audi Q7 4MB,4MG auch für Q7 3.0 TDI e-tron	07/15-			305 437 600 001		90	21.0	16.4	140	3500		305 417 300 113	→	Erweiterungssatz für Kfz. ohne elektrische Heckklappe									
												305 437 300 113		S	A	C1	E2	D	L1	H	60		
												305 447 300 113		S	CAN	C	E	D	L1	H	60		
KIT		305 544 900 113		90	22.1	16.4	140	3500		im KIT enthalten 305 437 300 113		S	CAN	C	E	D	L	H	60				
Audi Q7 auch für Q7 3.0 TDI e-tron	07/15-	KIT		305 437 900 113	→ 	90	23.7	16.4	140	3500		im KIT enthalten 305 417 300 113	→	S	A	C1	E2	D	L1	H	60		
Audi Q8 4MN nicht für Q8 e-tron	02/18-			322 064 600 001		60	27.0	15.7	191	3500		305 437 300 113		S	CAN	C	E	D	L	H	60		
												305 447 300 113		S	CAN	C	E	D	L1	H	60		
KIT		322 064 900 113		60	28.0	15.7	191	3500		im KIT enthalten 305 437 300 113		S	CAN	C	E	D	L	H	60				

























Audi Q8 E-tron GEG	11/22-			305 600 600 001		75	19.3	11.4	135	1800		305 437 300 113	11/22-	S	CAN	C	E	D	L	H	60		
												305 447 300 113	11/22- 2.0	inkl. WLC	S	CAN	C	E	D	L1	H	60	
		KIT		305 600 900 113		75	20.4	11.4	135	1800		im KIT enthalten 305 437 300 113	11/22-	S	CAN	C	E	D	L	H	60		
Audi Q8 E-tron Sportback GET	11/22-			305 600 600 001		75	19.3	11.4	135	1800		305 437 300 113	11/22-	S	CAN	C	E	D	L	H	60		
												305 447 300 113	11/22- 2.0	inkl. WLC	S	CAN	C	E	D	L1	H	60	
		KIT		305 600 900 113		75	20.4	11.4	135	1800		im KIT enthalten 305 437 300 113	11/22-	S	CAN	C	E	D	L	H	60		
Audi TT ist vom Hersteller nicht für den Anhängerbetrieb freigegeben.																							

















BMW



















BMW 1er Reihe Cabrio E88 135i nicht für den Anhängerbetrieb freigegeben.	01/08-01/14			303 323 600 001		60	20.0	8.0	90	1400		303 460 300 113			S	CAN	--	E2	D	L1	H	60
		KIT		303 323 900 113		60	22.0	8.0	90	1400		im KIT enthalten 303 460 300 113			S	CAN	--	E2	D	L1	H	60
BMW 1er Reihe Coupé E82 135i nicht für den Anhängerbetrieb freigegeben.	11/07-01/14			303 323 600 001		60	20.0	8.0	90	1400		303 460 300 113			S	CAN	--	E2	D	L1	H	60
		KIT		303 323 900 113		60	22.0	8.0	90	1400		im KIT enthalten 303 460 300 113			S	CAN	--	E2	D	L1	H	60
BMW 1er Reihe, 3-/5-Türer Steilheck F20/F21 auch für M-Sport-Paket Wärmeschutzblech für Steckdosenhalter bitte beim BMW-Händler beziehen, Nr. 7 277 733. 135i nicht für den Anhängerbetrieb freigegeben. Bei Fahrzeugen mit Benzin- Motoren bitte prüfen, ob ein Tausch des Nachschalldämpfers erforderlich ist.	09/11-03/14	KIT		303 317 900 113			22.0	8.8	75	1500		im KIT enthalten 303 460 300 113	-03/14		S	CAN	--	E2	D	L1	H	60
BMW 1er Reihe, 3-/5-Türer Steilheck F20/F21 nicht für M-Modelle, nicht für M- Sport-Paket 135i nicht für den Anhängerbetrieb freigegeben. Bei Fahrzeugen mit Benzin- Motoren bitte prüfen, ob ein Tausch des Nachschalldämpfers erforderlich ist.	09/11-03/14	KIT		303 320 900 113			19.5	8.8	75	1500		im KIT enthalten 303 460 300 113	-03/14		S	CAN	--	E2	D	L1	H	60
BMW 1er Reihe, 3-/5-Türer Steilheck F20/F21 nicht für M-Modelle, auch für M- Sport-Paket Wärmeschutzblech für Steckdosenhalter bitte beim BMW-Händler beziehen, Nr. 7 277 733. 135i nicht für den Anhängerbetrieb freigegeben. Bei Fahrzeugen mit Benzin- Motoren bitte prüfen, ob ein Tausch des Nachschalldämpfers erforderlich ist.	09/11-07/19			303 317 600 001		60	20.0	8.8	75	1500		303 460 300 113	-03/14		S	CAN	--	E2	D	L1	H	60
													303 481 300 113	03/14-07/19		S	CAN	--	E2	D	L1	H

BMW 1er Reihe, 3-/5-Türer Steilheck F20/F21 nicht für M-Modelle, nicht für M-Sport-Paket 135i nicht für den Anhängerbetrieb freigegeben. Bei Fahrzeugen mit Benzin-Motoren bitte prüfen, ob ein Tausch des Nachschalldämpfers erforderlich ist.	09/11-07/19			303 320 600 001			60	17.5	8.8	75	1500		303 460 300 113	-03/14	S	CAN	--	E2	D	L1	H	60
													303 481 300 113	03/14-07/19	S	CAN	--	E2	D	L1	H	90
BMW 1er Reihe, 3-/5-Türer Steilheck F20/F21 nicht für M-Modelle, auch für M-Sport-Paket Wärmeschutzblech für Steckdosenhalter bitte beim BMW-Händler beziehen, Nr. 7 277 733. 135i nicht für den Anhängerbetrieb freigegeben. Bei Fahrzeugen mit Benzin-Motoren bitte prüfen, ob ein Tausch des Nachschalldämpfers erforderlich ist.	03/14-07/19	KIT		303 001 900 113			60	20.5	8.8	75	1500		im KIT enthalten 303 481 300 113	03/14-07/19	S	CAN	--	E2	D	L1	H	90
BMW 1er Reihe, 3-/5-Türer Steilheck F20/F21 nicht für M-Modelle, nicht für M-Sport-Paket 135i nicht für den Anhängerbetrieb freigegeben. Bei Fahrzeugen mit Benzin-Motoren bitte prüfen, ob ein Tausch des Nachschalldämpfers erforderlich ist.	03/14-07/19	KIT		303 002 900 113			60	19.2	8.8	75	1500		im KIT enthalten 303 481 300 113	03/14-07/19	S	CAN	--	E2	D	L1	H	90
BMW 1er Reihe, 5-Türer Steilheck E87/E81 135i nicht für den Anhängerbetrieb freigegeben. Bei Fzg. Bauj. -07/05 müssen die Befestigungsbolzen am Fzg. von einer BMW-Fachwerkstatt gewechselt werden.	09/04-09/11			303 323 600 001			60	20.0	8.0	90	1400		303 460 300 113		S	CAN	--	E2	D	L1	H	60
		KIT		303 323 900 113			60	22.0	8.0	90	1400		im KIT enthalten 303 460 300 113		S	CAN	--	E2	D	L1	H	60















BMW



















BMW 1er Reihe, 5-Türer Steilheck F40 auch für Fahrzeuge mit M-Optik-Paket nicht für M135i xDrive Kühlsystem > 400 W muss ggf. nachgerüstet werden. nicht für Kfz. mit sensorgesteuerter Heckklappe (Fußsensor)	07/19-		303 497 600 001		60	20.0	8.6	100	1500		303 497 300 113	07/19-	S	CAN	--	E2	D	L1	V	90	
BMW 1er Reihe, 5-Türer Steilheck F40 auch für Fahrzeuge mit M-Optik-Paket nicht für M135i xDrive Kühlsystem > 400 W muss ggf. nachgerüstet werden. nicht für Kfz. mit sensorgesteuerter Heckklappe (Fußsensor)	07/19-		303 498 600 001		60	22.7	8.6	100	1500		303 497 300 113	07/19-	S	CAN	--	E2	D	L1	V	90	
		KIT		303 497 900 113		60	21.5	8.6	100	1500		im KIT enthalten 303 497 300 113	07/19-	S	CAN	--	E2	D	L1	V	90
		KIT		303 498 900 113		60	24.2	8.6	100	1500		im KIT enthalten 303 497 300 113	07/19-	S	CAN	--	E2	D	L1	V	90
BMW 2er Active Tourer F45 nicht für Hybrid	09/14-10/21		303 355 600 001		90	17.5	10.4	80	2000		303 372 300 113	→	S	CAN	--	E	D	L1	V	105	
			303 372 600 001		90	21.0	10.4	80	2000		303 480 300 113		09/14-	S	CAN	--	E	D	L1	V	105
		KIT		303 373 900 113		90	19.5	10.4	80	2000		im KIT enthalten 303 480 300 113	09/14-	S	CAN	--	E	D	L1	V	105
		KIT		303 374 900 113		90	21.0	10.4	80	2000		im KIT enthalten 303 480 300 113	09/14-	S	CAN	--	E	D	L1	V	105
BMW 2er Active Tourer U06	11/21-		303 516 600 001		75	18.0	8.3	75	1400		303 516 300 113	11/21-	S	CAN	--	E2	D	L1	V	90	
			303 517 600 001		75	20.0	8.3	75	1400												
		KIT		303 516 900 113		75	21.0	8.3	75	1400		im KIT enthalten 303 516 300 113	11/21-	S	CAN	--	E2	D	L1	V	90
		KIT		303 517 900 113		75	22.2	8.3	75	1400		im KIT enthalten 303 516 300 113	11/21-	S	CAN	--	E2	D	L1	V	90

BMW 2er Reihe Cabrio F23 nicht für M-Modelle	02/15-07/21			303 320 600 001			60	17.5	8.8	75	1500		303 481 300 113	02/15-21	S	CAN	--	E2	D	L1	H	90
				303 317 600 001			60	20.0	8.8	75	1500											
		KIT		303 002 900 113			60	19.2	8.8	75	1500		im KIT enthalten 303 481 300 113	02/15-21	S	CAN	--	E2	D	L1	H	90
		KIT		303 001 900 113			60	20.5	8.8	75	1500		im KIT enthalten 303 481 300 113	02/15-21	S	CAN	--	E2	D	L1	H	90
BMW 2er Reihe Coupé F22 nicht für M-Modelle	03/14-07/21			303 320 600 001			60	17.5	8.8	75	1500		303 481 300 113	03/14-21	S	CAN	--	E2	D	L1	H	90
				303 317 600 001			60	20.0	8.8	75	1500											
		KIT		303 002 900 113			60	19.2	8.8	75	1500		im KIT enthalten 303 481 300 113	03/14-21	S	CAN	--	E2	D	L1	H	90
		KIT		303 001 900 113			60	20.5	8.8	75	1500		im KIT enthalten 303 481 300 113	03/14-21	S	CAN	--	E2	D	L1	H	90
BMW 2er Reihe Gran Tourer F46	05/15-07/22			303 355 600 001		90	17.5	10.4	80	2000		303 372 300 113	→ -07/22	S	CAN	--	E	D	L1	V	105	
				303 372 600 001		90	21.0	10.4	80	2000												303 480 300 113
		KIT		303 373 900 113		90	19.5	10.4	80	2000		im KIT enthalten 303 480 300 113	05/15--07/22	S	CAN	--	E	D	L1	V	105	
		KIT		303 374 900 113		90	21.0	10.4	80	2000		im KIT enthalten 303 480 300 113	05/15--07/22	S	CAN	--	E	D	L1	V	105	
BMW 3er Reihe Cabrio E93 schräger Verlauf der Kugelstange, Aufnahmerohr ist nicht mittig auch für Modelle 335i und 335td bzw. Kfz. mit Abgasturbolader bitte Satz Halter für Schalldämpfer mitbestellen, Art.-Nr. 30326600015	03/06-02/14			303 266 600 001			27.0	10.0	75	1800		303 460 300 113		S	CAN	--	E2	D	L1	H	60	















BMW 3er Reihe Limousine F30 nicht für M3, auch für M-Sportpaket, nicht für 330e für Kfz. mit Benzinmotor bitte zusätzlich bestellen: Hitzeschutzblech erhältlich beim BMW-Händler Bügel für Hitzeschutzblech, Art.-Nr. 303352613001	02/12-03/14	KIT		303 352 900 113		60	23.5	10.0	75	1800		im KIT enthalten 303 460 300 113	-03/14	S	CAN	--	E2	D	L1	H	60	
BMW 3er Reihe Limousine F30 nicht für M3, auch für M-Sportpaket, nicht für 330e	02/12-11/18			303 351 600 001		60	21.0	10.0	75	1800		303 460 300 113 303 481 300 113	-03/14 03/14-11/18	S S	CAN CAN	-- --	E2 E2	D D	L1 L1	H H	60 90	
BMW 3er Reihe Limousine F30 nicht für M3, auch für M-Sportpaket, nicht für 330e für Kfz. mit Benzinmotor bitte zusätzlich bestellen: Hitzeschutzblech erhältlich beim BMW-Händler Bügel für Hitzeschutzblech, Art.-Nr. 303352613001	02/12-11/18			303 352 600 001		60	21.5	10.0	75	1800		303 460 300 113 303 481 300 113	-03/14 03/14-11/18	S S	CAN CAN	-- --	E2 E2	D D	L1 L1	H H	60 90	
BMW 3er Reihe Limousine F30 nicht für M3, auch für M-Sportpaket, nicht für 330e	03/14-11/18	KIT		303 004 900 113		60	20.7	10.0	75	1800		im KIT enthalten 303 481 300 113	03/14-11/18	S	CAN	--	E2	D	L1	H	90	
BMW 3er Reihe Limousine F30 nicht für M3, auch für M-Sportpaket, nicht für 330e für Kfz. mit Benzinmotor bitte zusätzlich bestellen: Hitzeschutzblech erhältlich beim BMW-Händler Bügel für Hitzeschutzblech, Art.-Nr. 303352613001	03/14-11/18	KIT		303 005 900 113		60	23.2	10.0	75	1800		im KIT enthalten 303 481 300 113	03/14-11/18	S	CAN	--	E2	D	L1	H	90	
BMW 3er Reihe Limousine G20 auch für M-Sport	11/18-			303 499 600 001		60	15.9	10.0	120	1800		303 504 300 113	11/18-	S	CAN	--	E2	D	L1	H	75	
			303 500 600 001		60	18.2	10.0	120	1800													
		KIT		303 499 900 113		60	17.6	10.0	120	1800		im KIT enthalten 303 504 300 113	11/18-	S	CAN	--	E2	D	L1	H	75	
		KIT		303 500 900 113		60	19.9	10.0	120	1800		im KIT enthalten 303 504 300 113	11/18-	S	CAN	--	E2	D	L1	H	75	























BMW

BMW 3er Reihe Touring E91 nicht für M3, auch für M Sport schräger Verlauf der Kugelstange; Aufnahmerohr ist nicht mittig Für Modelle 335i und 335d bzw. Kfz. mit 2 Abgasturboladern bitte Satz Halter für Schalldämpfer mitbestellen, Art.-Nr. 303240600015	09/05-08/12			303 330 600 001		75	26.5	10.0	75	1800		303 460 300 113	-03/14	S	CAN	--	E2	D	L1	H	60
		KIT		303 330 900 113		75	27.5	10.0	75	1800		im KIT enthalten 303 460 300 113	-03/14	S	CAN	--	E2	D	L1	H	60
BMW 3er Reihe Touring E91 nicht für M3 schräger Verlauf der Kugelstange nicht für 335i und 335d bzw. Kfz. mit 2 Abgasturboladern	09/05-08/12	KIT		303 331 900 113		75	21.0	9.2	75	1800		im KIT enthalten 303 460 300 113	-03/14	S	CAN	--	E2	D	L1	H	60
BMW 3er Reihe Touring E91 nicht für M3 schräger Verlauf der Kugelstange nicht für 335i und 335d bzw. Kfz. mit 2 Abgasturboladern	09/05-08/12			303 428 600 001		75	17.4	9.2	75	1800		303 460 300 113	-03/14	S	CAN	--	E2	D	L1	H	60
BMW 3er Reihe Touring F31 nicht für M3, auch für M- Sportpaket, nicht für 330e	09/12-03/14	KIT		303 351 900 113		60	23.0	10.0	75	1800		im KIT enthalten 303 460 300 113	-03/14	S	CAN	--	E2	D	L1	H	60
BMW 3er Reihe Touring F31 nicht für M3, auch für M- Sportpaket, nicht für 330e für Kfz. mit Benzinmotor bitte zusätzlich bestellen: Hitzeschutzblech erhältlich beim BMW-Händler Bügel für Hitzeschutzblech, Art.- Nr. 303352613001	09/12-03/14	KIT		303 352 900 113		60	23.5	10.0	75	1800		im KIT enthalten 303 460 300 113	-03/14	S	CAN	--	E2	D	L1	H	60
BMW 3er Reihe Touring F31 nicht für M3, auch für M- Sportpaket, nicht für 330e	09/12-06/19			303 351 600 001		60	21.0	10.0	75	1800		303 460 300 113	-03/14	S	CAN	--	E2	D	L1	H	60
												303 481 300 113	03/14-06/19	S	CAN	--	E2	D	L1	H	90
BMW 3er Reihe Touring F31 nicht für M3, auch für M- Sportpaket, nicht für 330e für Kfz. mit Benzinmotor bitte zusätzlich bestellen: Hitzeschutzblech erhältlich beim BMW-Händler Bügel für Hitzeschutzblech, Art.- Nr. 303352613001	09/12-06/19			303 352 600 001		60	21.5	10.0	75	1800		303 460 300 113	-03/14	S	CAN	--	E2	D	L1	H	60
												303 481 300 113	03/14-06/19	S	CAN	--	E2	D	L1	H	90



















BMW 3er Reihe Touring F31 nicht für M3, auch für M-Sportpaket, nicht für 330e	03/14-06/19	KIT		303 004 900 113		60	20.7	10.0	75	1800		im KIT enthalten 303 481 300 113	03/14-06/19	S	CAN	--	E2	D	L1	H	90
BMW 3er Reihe Touring F31 nicht für M3, auch für M-Sportpaket, nicht für 330e für Kfz. mit Benzinmotor bitte zusätzlich bestellen: Hitzeschutzblech erhältlich beim BMW-Händler Bügel für Heitzschutzblech, Art.-Nr. 303352613001	03/14-06/19	KIT		303 005 900 113		60	23.2	10.0	75	1800		im KIT enthalten 303 481 300 113	03/14-06/19	S	CAN	--	E2	D	L1	H	90
BMW 3er Reihe Touring G21 auch für M-Sport	07/19-			303 499 600 001		60	15.9	10.0	120	1800		303 504 300 113	07/19-	S	CAN	--	E2	D	L1	H	75
				303 500 600 001		60	18.2	10.0	120	1800											
		KIT		303 499 900 113		60	17.6	10.0	120	1800		im KIT enthalten 303 504 300 113	07/19-	S	CAN	--	E2	D	L1	H	75
		KIT		303 500 900 113		60	19.9	10.0	120	1800		im KIT enthalten 303 504 300 113	07/19-	S	CAN	--	E2	D	L1	H	75
BMW 4er Reihe Cabrio F33 nicht für M-Modelle auch für M-Sportpaket	03/14-11/20			303 351 600 001		60	21.0	10.0	75	1800		303 481 300 113	03/14-11/20	S	CAN	--	E2	D	L1	H	90
BMW 4er Reihe Cabrio F33 nicht für M-Modelle auch für M-Sportpaket für Kfz. mit Benzinmotor bitte zusätzlich bestellen: Hitzeschutzblech erhältlich beim BMW-Händler Bügel für Heitzschutzblech, Art.-Nr. 303352613001	03/14-11/20			303 352 600 001		60	21.5	10.0	75	1800		303 481 300 113	03/14-11/20	S	CAN	--	E2	D	L1	H	90
BMW 4er Reihe Cabrio F33 auch für M-Sportpaket	03/14-11/20	KIT		303 004 900 113		60	20.7	10.0	75	1800		im KIT enthalten 303 481 300 113	03/14-11/20	S	CAN	--	E2	D	L1	H	90





















BMW

BMW 4er Reihe Cabrio F33 auch für M-Sportpaket für Kfz. mit Benzinmotor bitte zusätzlich bestellen: Hitzeschutzblech erhältlich beim BMW-Händler Bügel für Hitzeschutzblech, Art.- Nr. 303352613001	03/14-11/20	KIT		303 005 900 113		60	23.2	10.0	75	1800		im KIT enthalten 303 481 300 113	03/14-11/20	S	CAN	--	E2	D	L1	H	90
BMW 4er Reihe Cabrio G23 nicht für M4	12/20-			303 499 600 001		60	15.9	10.0	120	1800		303 504 300 113	12/20-	S	CAN	--	E2	D	L1	H	75
BMW 4er Reihe Coupé F32 nicht für M-Modelle auch für M-Sportpaket	10/13-03/14	KIT		303 351 900 113		60	23.0	10.0	75	1800		im KIT enthalten 303 460 300 113	-03/14	S	CAN	--	E2	D	L1	H	60
BMW 4er Reihe Coupé F32 nicht für M-Modelle auch für M-Sportpaket für Kfz. mit Benzinmotor bitte zusätzlich bestellen: Hitzeschutzblech erhältlich beim BMW-Händler Bügel für Hitzeschutzblech, Art.- Nr. 303352613001	10/13-03/14	KIT		303 352 900 113		60	23.5	10.0	75	1800		im KIT enthalten 303 460 300 113	-03/14	S	CAN	--	E2	D	L1	H	60
BMW 4er Reihe Coupé F32 nicht für M-Modelle auch für M-Sportpaket	10/13-11/20			303 351 600 001		60	21.0	10.0	75	1800		303 460 300 113 303 481 300 113	-03/14 03/14-11/20	S S	CAN CAN	-- --	E2 E2	D D	L1 L1	H H	60 90
BMW 4er Reihe Coupé F32 nicht für M-Modelle auch für M-Sportpaket für Kfz. mit Benzinmotor bitte zusätzlich bestellen: Hitzeschutzblech erhältlich beim BMW-Händler Bügel für Hitzeschutzblech, Art.- Nr. 303352613001	10/13-11/20			303 352 600 001		60	21.5	10.0	75	1800		303 460 300 113 303 481 300 113	-03/14 03/14-11/20	S S	CAN CAN	-- --	E2 E2	D D	L1 L1	H H	60 90
BMW 4er Reihe Coupé F32 auch für M-Sportpaket	03/14-11/20	KIT		303 004 900 113		60	20.7	10.0	75	1800		im KIT enthalten 303 481 300 113	03/14-11/20	S	CAN	--	E2	D	L1	H	90













BMW 4er Reihe Coupé F32 auch für M-Sportpaket für Kfz. mit Benzinmotor bitte zusätzlich bestellen: Hitzeschutzblech erhältlich beim BMW-Händler Bügel für Hitzeschutzblech, Art.- Nr. 303352613001	03/14-11/20	KIT		303 005 900 113		60	23.2	10.0	75	1800		im KIT enthalten 303 481 300 113	03/14-11/20	S	CAN	--	E2	D	L1	H	90
BMW 4er Reihe Coupé G22 nicht für M4	12/20-			303 499 600 001		60	15.9	10.0	120	1800		303 504 300 113	11/20-	S	CAN	--	E2	D	L1	H	75
				303 500 600 001		60	18.2	10.0	120	1800											
		KIT		303 499 900 113		60	17.6	10.0	120	1800		im KIT enthalten 303 504 300 113	11/20-	S	CAN	--	E2	D	L1	H	75
		KIT		303 500 900 113		60	19.9	10.0	120	1800		im KIT enthalten 303 504 300 113	11/20-	S	CAN	--	E2	D	L1	H	75
BMW 4er Reihe Gran Coupé F36 auch für M-Sportpaket nicht für M-Modelle	06/14-06/21			303 351 600 001		60	21.0	10.0	75	1800		303 481 300 113	06/14-06/21	S	CAN	--	E2	D	L1	H	90
		KIT		303 004 900 113		60	20.7	10.0	75	1800		im KIT enthalten 303 481 300 113	06/14-06/21	S	CAN	--	E2	D	L1	H	90
BMW 4er Reihe Gran Coupé F36 auch für M-Sportpaket nicht für M-Modelle für Kfz. mit Benzinmotor bitte zusätzlich bestellen: Hitzeschutzblech erhältlich beim BMW-Händler Bügel für Hitzeschutzblech, Art.- Nr. 303352613001	06/14-06/21			303 352 600 001		60	21.5	10.0	75	1800		303 481 300 113	06/14-06/21	S	CAN	--	E2	D	L1	H	90
		KIT		303 005 900 113		60	23.2	10.0	75	1800		im KIT enthalten 303 481 300 113	06/14-06/21	S	CAN	--	E2	D	L1	H	90
BMW 4er Reihe Gran Coupé G26	07/21-			303 514 600 001		75	17.1	12.3	145	2250		303 504 300 113	07/21-	S	CAN	--	E2	D	L1	H	75
		KIT		303 514 900 113		75	18.8	12.3	145	2250		im KIT enthalten 303 504 300 113	07/21-	S	CAN	--	E2	D	L1	H	75





















BMW

BMW 5er Reihe Limousine E60 nicht für M5, nur für Kfz. mit Sportpaket. Ablage für Kugelstange 903186631101 (nicht für Fzg mit Notrad) Klappe für Stoßfängerausschnitt 5112 7120 005 bitte beim BMW-Händler beziehen.	07/03-02/10			303 235 600 001		150	20.0	11.4	90	2200		303 460 300 113	-07/13	S	CAN	--	E2	D	L1	H	60
		KIT		303 235 900 113		150	22.0	11.4	90	2200		im KIT enthalten 303 460 300 113	-07/13	S	CAN	--	E2	D	L1	H	60
BMW 5er Reihe Limousine E60 nicht für M5, nicht für Kfz. mit Sportpaket.	07/03-02/10			303 294 600 001		100	20.0	11.4	90	2200		303 460 300 113	-07/13	S	CAN	--	E2	D	L1	H	60
		KIT		303 294 900 113		100	22.0	11.4	90	2200		im KIT enthalten 303 460 300 113	-07/13	S	CAN	--	E2	D	L1	H	60
BMW 5er Reihe Limousine F10 nicht für M5 auch für M-Sport-Paket	03/10-07/13	KIT		303 337 900 113		45	25.0	11.8	100	2200		im KIT enthalten 303 460 300 113	-07/13	S	CAN	--	E2	D	L1	H	60
		KIT		303 338 900 113		45	30.0	11.8	100	2200		im KIT enthalten 303 460 300 113	-07/13	S	CAN	--	E2	D	L1	H	60
BMW 5er Reihe Limousine F10 nicht für M5 auch für M-Sport-Paket	03/10-01/17			303 397 600 001		45	23.0	11.8	100	2200		303 460 300 113	-07/13	S	CAN	--	E2	D	L1	H	60
				303 398 600 001		45	28.0	11.8	100	2200		303 481 300 113	07/13-01/17	S	CAN	--	E2	D	L1	H	90
BMW 5er Reihe Limousine F10 nicht für M5 auch für M-Sport-Paket	07/13-01/17	KIT		303 007 900 113		45	24.7	11.8	100	2200		im KIT enthalten 303 481 300 113	07/13-01/17	S	CAN	--	E2	D	L1	H	90
		KIT		303 008 900 113		45	20.2	11.8	100	2200		im KIT enthalten 303 481 300 113	07/13-01/17	S	CAN	--	E2	D	L1	H	90





























BMW 5er Reihe Limousine G30	02/17-10/23			303 413 600 001			60	20.5	11.9	90	2000		303 504 300 113	02/17-10/23	S	CAN	--	E2	D	L1	H	75
				303 412 600 001			60	21.9	11.9	90	2000											
		KIT		303 012 900 113			60	21.8	11.9	90	2000		im KIT enthalten 303 504 300 113	02/17-10/23	S	CAN	--	E2	D	L1	H	75
		KIT		303 013 900 113			60	24.1	11.9	90	2000		im KIT enthalten 303 504 300 113	02/17-10/23	S	CAN	--	E2	D	L1	H	75
BMW 5er Reihe Touring E61 nicht für M5, nur für Kfz. mit Sportpaket. Klappe für Stoßängerausschnitt 5112 7126 377 bitte beim BMW-Händler bestellen. Ablage für Kugelstange 903186631101 (nicht für Fzg mit Notrad)	07/04-09/10			303 235 600 001			150	20.0	11.4	90	2200		303 460 300 113	-07/13	S	CAN	--	E2	D	L1	H	60
		KIT		303 235 900 113			150	22.0	11.4	90	2200		im KIT enthalten 303 460 300 113	-07/13	S	CAN	--	E2	D	L1	H	60
BMW 5er Reihe Touring E61 nicht für M5, nicht für Kfz. mit Sportpaket.	07/04-09/10			303 294 600 001			100	20.0	11.4	90	2200		303 460 300 113	-07/13	S	CAN	--	E2	D	L1	H	60
		KIT		303 294 900 113			100	22.0	11.4	90	2200		im KIT enthalten 303 460 300 113	-07/13	S	CAN	--	E2	D	L1	H	60
BMW 5er Reihe Touring F11 auch für M-Sport-Paket	09/10-07/13	KIT		303 337 900 113			45	25.0	11.8	100	2200		im KIT enthalten 303 460 300 113	-07/13	S	CAN	--	E2	D	L1	H	60
		KIT		303 338 900 113			45	30.0	11.8	100	2200		im KIT enthalten 303 460 300 113	-07/13	S	CAN	--	E2	D	L1	H	60
BMW 5er Reihe Touring F11 auch für M-Sport-Paket	09/10-01/17			303 397 600 001			45	23.0	11.8	100	2200		303 460 300 113	-07/13	S	CAN	--	E2	D	L1	H	60
				303 398 600 001			45	28.0	11.8	100	2200		303 481 300 113	07/13-01/17	S	CAN	--	E2	D	L1	H	90
BMW 5er Reihe Touring F11 auch für M-Sport-Paket	07/13-01/17	KIT		303 008 900 113			45	20.2	11.8	100	2200		im KIT enthalten 303 481 300 113	07/13-01/17	S	CAN	--	E2	D	L1	H	90





















BMW

BMW 5er Reihe Touring G31	02/17-10/23			303 413 600 001			60	20.5	11.9	90	2000		303 504 300 113	02/17-10/23	S	CAN	--	E2	D	L1	H	75
				303 412 600 001			60	21.9	11.9	90	2000											
	KIT		303 012 900 113			60	21.8	11.9	90	2000		im KIT enthalten 303 504 300 113	02/17-10/23	S	CAN	--	E2	D	L1	H	75	
	KIT		303 013 900 113			60	24.1	11.9	90	2000		im KIT enthalten 303 504 300 113	02/17-10/23	S	CAN	--	E2	D	L1	H	75	
BMW 6er Reihe ist vom Hersteller nicht für den Anhängerbetrieb freigegeben.																						
BMW 6er Reihe Gran Turismo G32	06/17-10/23			303 413 600 001			60	20.5	11.9	90	2000		303 504 300 113	06/17-10/23	S	CAN	--	E2	D	L1	H	75
				303 412 600 001			60	21.9	11.9	90	2000											
	KIT		303 012 900 113			60	21.8	11.9	90	2000		im KIT enthalten 303 504 300 113	06/17-10/23	S	CAN	--	E2	D	L1	H	75	
	KIT		303 013 900 113			60	24.1	11.9	90	2000		im KIT enthalten 303 504 300 113	06/17-10/23	S	CAN	--	E2	D	L1	H	75	
BMW 7er Reihe Limousine G11/12 auch für Facelift 2019- nicht für M-Modelle, nicht für 745e	07/15-05/22			303 413 600 001			60	20.5	11.9	90	2000											
				303 412 600 001			60	21.9	11.9	90	2000											
BMW M5 Anhängerkupplung nur beim BMW-Händler erhältlich.																						
BMW X1 E84 Nicht für Fahrzeuge mit werksseitig montiertem Fahrradträger auch für M-Sport-Paket / X-drive	10/09-10/15	KIT		303 313 900 113			90	19.0	10.3	80	2000		im KIT enthalten 303 460 300 113		S	CAN	--	E2	D	L1	H	60
		KIT		303 314 900 113			90	20.0	10.3	80	2000		im KIT enthalten 303 460 300 113		S	CAN	--	E2	D	L1	H	60



















BMW X1 E84 Nicht für Fahrzeuge mit werksseitig montiertem Fahrradträger auch für M-Sport-Paket / X-drive	10/09-10/15		303 393 600 001			90	17.0	10.3	80	2000		303 460 300 113									S	CAN	--	E2	D	L1	H	60															
			303 394 600 001			90	18.0	10.3	80	2000																																	
BMW X1 F48 auch für M-Sport-Paket Bei Fzg. mit Heckklappensensor muss die Sensorleitung angepasst werden.	10/15-10/22		303 355 600 001			90	17.5	10.4	80	2000		303 372 300 113	→															S	CAN	--	E	D	L1	V	105								
			303 372 600 001			90	21.0	10.4	80	2000																				10/15-	S	CAN	--	E	D	L1	V	105					
		KIT		303 373 900 113			90	19.5	10.4	80	2000		im KIT enthalten 303 480 300 113		10/15-	S	CAN	--	E	D	L1	V	105																				
		KIT		303 374 900 113			90	21.0	10.4	80	2000		im KIT enthalten 303 480 300 113		10/15-	S	CAN	--	E	D	L1	V	105																				
BMW X2 F39 nicht für M35i nur für Fahrzeuge mit Einfachrohr rechts und links	11/17-		303 475 600 001			75	29.0	12.0	130	2500		303 372 300 113	→																	S	CAN	--	E	D	L1	V	105						
			303 476 600 001			75	29.0	12.0	130	2500																						11/17-	S	CAN	--	E	D	L1	V	105			
		KIT		303 480 900 113			75	31.0	12.0	130	2500		im KIT enthalten 303 480 300 113		11/17-	S	CAN	--	E	D	L1	V	105																				
BMW X3 je nach Ausstattung teilweise Ausschnitt + Klappe erforderlich. Bitte beim BMW-Händler bestellen.	01/04-11/10		303 304 600 001				21.0	12.6	100	2200		303 189 300 113																						S	FRE	--	E	D	L1	V	120		
			KIT				303 304 900 113																											23.0	12.6	100	2200		im KIT enthalten 303 189 300 113			S	FRE
BMW X3	01/04-11/10		303 327 600 001				16.0	10.9	85	2000		303 189 300 113																								S	FRE	--	E	D	L1	V	120
			KIT				303 327 900 113																													18.0	10.9	85	2000		im KIT enthalten 303 189 300 113		











BMW



















BMW X3 F25 auch für M-Sport	11/10-09/14	KIT		303 339 900 113		60	18.5	12.5	100	2400		im KIT enthalten 303 460 300 113	-09/14	S	CAN	--	E2	D	L1	H	60	
		KIT		303 340 900 113		60	19.5	12.5	100	2400		im KIT enthalten 303 460 300 113	-09/14	S	CAN	--	E2	D	L1	H	60	
BMW X3 F25 auch für M-Sport	11/10-06/17			303 339 600 001		60	16.0	12.0	100	2400		303 460 300 113	-09/14	S	CAN	--	E2	D	L1	H	60	
				303 404 600 001		60	16.8	12.6	100	2400		303 481 300 113	10/14 -06/17	S	CAN	--	E2	D	L1	H	90	
BMW X3 F25 auch für M-Sport	10/14-06/17	KIT		303 009 900 113		60	16.7	12.0	100	2400		im KIT enthalten 303 481 300 113	10/14 -06/17	S	CAN	--	E2	D	L1	H	90	
		KIT		303 010 900 113		60	17.5	12.6	100	2400		im KIT enthalten 303 481 300 113	10/14 -06/17	S	CAN	--	E2	D	L1	H	90	
BMW X3 G01 auch für M-Sport auch für Facelift nicht für iX3	07/17-			303 495 600 001		60	18.0	12.5	100	2400		303 504 300 113	07/17-	S	CAN	--	E2	D	L1	H	75	
				303 496 600 001		60	20.0	12.5	100	2400												
		KIT		303 014 900 113		60	20.2	12.5	100	2400		im KIT enthalten 303 504 300 113	07/17-	S	CAN	--	E2	D	L1	H	75	
		KIT		303 015 900 113		60	23.7	12.5	100	2400		im KIT enthalten 303 504 300 113	07/17-	S	CAN	--	E2	D	L1	H	75	
BMW X4 F26 auch für M-Sport	06/14-04/18			303 404 600 001		60	16.8	12.6	100	2400		303 481 300 113	06/14 -04/18	S	CAN	--	E2	D	L1	H	90	
		KIT		303 010 900 113		60	17.5	12.6	100	2400		im KIT enthalten 303 481 300 113	06/14 -04/18	S	CAN	--	E2	D	L1	H	90	
BMW X4 G02 auch für M-Sport auch für Facelift 21-	05/18-			303 483 600 001		75	19.0	12.5	100	2400		303 504 300 113	05/18-	S	CAN	--	E2	D	L1	H	75	
		KIT		303 016 900 113		75	21.8	12.5	100	2400		im KIT enthalten 303 504 300 113	05/18-	S	CAN	--	E2	D	L1	H	75	























BMW X5 E53 auch für M-Sport Fahrzeuge mit US-Standard bzw. Grau-Importe können nicht nachgerüstet werden.	06/00-12/06			303 207 600 001			34.0	15.5	150	3500		303 137 300 113		für Kfz. mit Vorrüstung	S	FRE	--	E	D	--	H	30
BMW X5 E53 für Fzg. mit Vorrüstung auch für M-Sport Fahrzeuge mit US-Standard bzw. Grau-Importe können nicht nachgerüstet werden.	06/00-12/06	KIT		303 207 900 113			36.0	15.5	150	3500		im KIT enthalten 303 137 300 113		für Kfz. mit Vorrüstung	S	FRE	--	E	D	--	H	30
BMW X5 E70 auch für X5 M-Sport-Paket	01/07-10/13			303 368 600 001		90	26.5	16.0	150	3500		303 368 300 113	→	11/13-07/18 nicht für X5M- Motorisierung	S	CAN	--	E2	D	L1	H	45
												303 451 300 113		-11/13 nicht für X5M-Motorisierung	S	CAN	--	E	D	L1	H	45
												303 481 300 113		11/13-07/18 nicht für X5M- Motorisierung	S	CAN	--	E2	D	L1	H	90
BMW X5 E70 auch für X5 M-Sport-Paket	01/07-11/13	KIT		303 273 900 113		60	31.0	15.5	150	3500		im KIT enthalten 303 451 300 113		-11/13 nicht für X5M-Motorisierung	S	CAN	--	E	D	L1	H	45
BMW X5 F15 auch für M-Sport	11/13-07/18	KIT		303 368 900 113	→ 	90	28.5	16.0	150	3500		im KIT enthalten 303 368 300 113	→	11/13-07/18 nicht für X5M- Motorisierung	S	CAN	--	E2	D	L1	H	45
		KIT		303 011 900 113		90	25.2	16.0	150	3500		im KIT enthalten 303 481 300 113		11/13-07/18 nicht für X5M- Motorisierung	S	CAN	--	E2	D	L1	H	90
BMW X5 F15 auch für M-Sport-Paket	11/13-07/18			303 368 600 001		90	26.5	16.0	150	3500		303 368 300 113	→	11/13-07/18 nicht für X5M- Motorisierung	S	CAN	--	E2	D	L1	H	45
BMW X5 G05 auch für M-Sport	08/18-			303 485 600 001		60	23.6	16.3	140	3500												
		KIT		303 485 900 113		60	25.4	16.3	140	3500		im KIT enthalten 303 504 300 113		08/18-	S	CAN	--	E2	D	L1	H	75
BMW X6 auch für X6M Hybridmodelle sind vom Fahrzeughersteller nicht für den Anhängerbetrieb freigegeben. Blende + Klappe für Stoßfängerausschnitt beim BMW- Händler erhältlich.	05/08-12/14			303 290 600 001			31.5	16.0	140	3500		303 451 300 113		nicht für X6M- Motorisierung	S	CAN	--	E	D	L1	H	45
		KIT		303 290 900 113			33.5	16.0	140	3500		im KIT enthalten 303 451 300 113		nicht für X6M- Motorisierung	S	CAN	--	E	D	L1	H	45

BMW

BMW X6 F16	12/14-19			303 368 600 001		90	26.5	16.0	150	3500		303 368 300 113	→	12/14-07/19 nicht für X6M- Motorisierung	S	CAN	--	E2	D	L1	H	45	
												303 481 300 113		12/14-19 nicht für X5M-Motorisierung	S	CAN	--	E2	D	L1	H	90	
		KIT		303 368 900 113	→		90	28.5	16.0	150	3500		im KIT enthalten 303 368 300 113	→	12/14-07/19 nicht für X6M- Motorisierung	S	CAN	--	E2	D	L1	H	45
		KIT		303 011 900 113			90	25.2	16.0	150	3500		im KIT enthalten 303 481 300 113		12/14-19 nicht für X5M-Motorisierung	S	CAN	--	E2	D	L1	H	90
BMW X6 G06 auch für M-Sport	08/19-			303 485 600 001		60	23.6	16.3	140	3500													
		KIT		303 485 900 113			60	25.4	16.3	140	3500		im KIT enthalten 303 504 300 113		08/19-	S	CAN	--	E2	D	L1	H	75
BMW i4 G26	11/21-			303 514 600 001		75	17.1	12.3	145	2250		303 504 300 113		11/21-	S	CAN	--	E2	D	L1	H	75	
		KIT		303 514 900 113			75	18.8	12.3	145	2250		im KIT enthalten 303 504 300 113		11/21-	S	CAN	--	E2	D	L1	H	75
BMW iX3 G08	09/20-			303 513 600 001		60	15.9	5.8	75	750		303 504 300 113		09/20-	S	CAN	--	E2	D	L1	H	75	
		KIT		303 513 900 113			60	17.6	5.8	75	750		im KIT enthalten 303 504 300 113		09/20-	S	CAN	--	E2	D	L1	H	75























Chevrolet Captiva (S3X)	06/06-09/18		342 217 600 001		90	21.5	12.3	150	2500	342 027 300 113	→	für Fzg. mit Vorrüstung	S	FRE	--	E1	D	L1	H	30	
Chevrolet Trax	03/13-06/19		314 511 600 001		60	21.5	8.6	75	1400	314 386 300 113			S	CAN	--	E	D	L1	V	90	
			314 510 600 001		60	21.0	8.6	75	1400					S	CAN	--	E	D	L1	V	90
		KIT		314 511 900 113		60	25.0	8.6	75	1400	im KIT enthalten 314 386 300 113			S	CAN	--	E	D	L1	V	90
		KIT		314 497 900 113		60	23.0	7.5	75	1200	im KIT enthalten 314 386 300 113			S	CAN	--	E	D	L1	V	90























Citroën Berlingo Kasten, Kombi Multispace	11/96-04/08			304 054 600 001		90	14.8	7.8	70	1350		304 054 300 113			S	FRE	--	E1	D1	--	V	75
		KIT		304 054 900 113		90	16.8	7.8	70	1350		im KIT enthalten 304 054 300 113			S	FRE	--	E1	D1	--	V	75
Citroën Berlingo First	04/08-12/11			304 054 600 001		90	14.8	7.8	70	1350		304 054 300 113			S	FRE	--	E1	D1	--	V	75
		KIT		304 054 900 113		90	16.8	7.8	70	1350		im KIT enthalten 304 054 300 113			S	FRE	--	E1	D1	--	V	75
Citroën Berlingo L1 kurzer Überhang, Fzg.-Länge = 4380 mm auch für Multispace, auch für Berlingo E-Car	04/08-11/11	KIT		304 091 900 113		90	17.0	8.7	64	1600		im KIT enthalten 304 400 300 113	-11/11 -> OPR12775	S	CAN	C1	E	D	L1	H	105	
		KIT		304 092 900 113		90	21.0	8.7	64	1600		im KIT enthalten 304 400 300 113	-11/11 -> OPR12775	S	CAN	C1	E	D	L1	H	105	
Citroën Berlingo L1 kurzer Überhang, Fzg.-Länge = 4380 mm auch für Multispace, auch für Berlingo E-Car	04/08-08/18			304 091 600 001		90	15.0	8.7	64	1600		304 400 300 113	-11/11 -> OPR12775	S	CAN	C1	E	D	L1	H	105	
				304 092 600 001		90	19.0	8.7	64	1600		304 402 300 107	11/11- OPR12776->	S	CAN	C1	E	--	--	V	105	
												304 402 300 113	11/11- OPR12776->	S	CAN	C1	E	D	L1	V	105	
Citroën Berlingo L1 auch für Berlingo Van inkl. Kugelplatte	09/18-			304 118 600 001		90	17.0	8.4	64	1600		314 594 300 113	inkl. WLC 2.0	S	A	C	E	D	L	V	90	
Citroën Berlingo L1 auch für Berlingo Van	09/18-			304 207 600 001		60	20.0	8.6	75	1500												
				304 209 600 001		60	20.5	8.6	75	1500		314 594 300 113	inkl. WLC 2.0	S	A	C	E	D	L	V	90	
		KIT		304 207 900 113		60	21.2	8.6	75	1500		im KIT enthalten 314 594 300 113	inkl. WLC 2.0	S	A	C	E	D	L	V	90	
		KIT		304 209 900 113		60	21.8	8.6	75	1500		im KIT enthalten 314 594 300 113	inkl. WLC 2.0	S	A	C	E	D	L	V	90	
Citroën Berlingo L2 langer Überhang, Fzg.-Länge = 4628 mm	04/08-11/11	KIT		304 129 900 113		90	18.3	8.7	64	1600		im KIT enthalten 304 400 300 113	-11/11 -> OPR12775	S	CAN	C1	E	D	L1	H	105	

Citroën C3 Aircross II 120HP Turbo S&S EAT6 (DV5RC / AT6) prüfen, ob Anhängelast eingetragen ist	06/17-	KIT		304 203 900 113		60	21.0	6.4	78	1000		im KIT enthalten 304 203 300 113	06/17- inkl. WLC 2.0	S	A	C	E2	D1	L1	V	60
		KIT		304 204 900 113		60	23.2	6.4	78	1000		im KIT enthalten 304 203 300 113	06/17- inkl. WLC 2.0	S	A	C	E2	D1	L1	V	60
Citroën C3 Picasso	03/09-07/17			304 127 600 001		60	15.2	7.3	61	1200		304 402 300 107 304 402 300 113		S	CAN	C1	E	--	--	V	105
		KIT		304 127 900 113		60	17.2	7.3	61	1200		im KIT enthalten 304 402 300 113		S	CAN	C1	E	D	L1	V	105
Citroën C4 Aircross	03/12-04/17			340 092 600 001		90	22.0	8.5	70	1400		340 093 300 113		S	A	--	--	D	L	H	60
				340 093 600 001		90	24.0	8.5	70	1400				S	A	--	--	D	L	H	60
		KIT		340 092 900 113		90	24.0	8.5	70	1400		im KIT enthalten 340 093 300 113		S	A	--	--	D	L	H	60
		KIT		340 093 900 113		90	26.0	8.5	70	1400		im KIT enthalten 340 093 300 113		S	A	--	--	D	L	H	60
Citroën C4 Cactus nicht für AdBlue	09/14-09/20			304 159 600 001			17.0	5.2	55	780		304 203 300 113 315 185 300 113	04/18-09/20 inkl. WLC 2.0 -03/18	S	A	C	E2	D1	L1	V	60
													S	CAN	C	E	D	L1	V	60	
Citroën C4 Grand Picasso	11/06-01/11	KIT		304 099 900 113		60	24.0	9.7	75	1700		im KIT enthalten 304 401 300 113	-01/11 ->OPR12531	S	CAN	C1	E	D	L1	V	105
		KIT		304 100 900 113		60	24.7	9.7	80	1700		im KIT enthalten 304 401 300 113	-01/11 ->OPR12531	S	CAN	C1	E	D	L1	V	105
Citroën C4 Grand Picasso	11/06-09/13			315 177 600 001		120	21.0	10.0	75	1550		304 401 300 113	-01/11 ->OPR12531	S	CAN	C1	E	D	L1	V	105
				315 178 600 001		90	22.5	9.7	80	1700		315 109 300 113	01/11- OPR12530->	S	CAN	C	E	D	L1	V	105





























Citroën













Citroën

Citroën C4 Grand Picasso / Grand Space Tourer auch für AdBlue	10/13-06/22			304 151 600 001		90	21.0	9.5	75	1750		315 196 300 113	-06/22	S	CAN	C	E2	D	L1	V	75
				304 152 600 001		90	24.0	9.5	75	1750											
	KIT		304 151 900 113		90	21.0	9.5	75	1750		im KIT enthalten 315 196 300 113	-06/22	S	CAN	C	E2	D	L1	V	75	
	KIT		304 152 900 113		90	24.0	9.5	75	1750		im KIT enthalten 315 196 300 113	-06/22	S	CAN	C	E2	D	L1	V	75	
Citroën C4 III nicht für ë-C4	10/20-			304 213 600 001		90	23.7	8.5	103	1400		304 203 300 113	10/20- nicht für ë- C4	S	A	C	E2	D1	L1	V	60
		KIT		304 202 900 113		90	25.4	8.5	103	1400		im KIT enthalten 304 203 300 113	10/20- nicht für ë- C4	S	A	C	E2	D1	L1	V	60
Citroën C4 Limousine	11/10-05/18			304 148 600 001		60	19.0	9.2	75	1550		304 144 300 113		S	CAN	C	E	D	L	V	90
		KIT		304 148 900 113		60	21.0	9.2	75	1550		im KIT enthalten 304 144 300 113		S	CAN	C	E	D	L	V	90
Citroën C4 Picasso	11/06-01/11	KIT		304 099 900 113		60	24.0	9.7	75	1700		im KIT enthalten 304 401 300 113	-01/11 ->OPR12531	S	CAN	C1	E	D	L1	V	105
		KIT		304 100 900 113		60	24.7	9.7	80	1700		im KIT enthalten 304 401 300 113	-01/11 ->OPR12531	S	CAN	C1	E	D	L1	V	105
Citroën C4 Picasso	11/06-05/13			315 177 600 001		120	21.0	10.0	75	1550		304 401 300 113	-01/11 ->OPR12531	S	CAN	C1	E	D	L1	V	105
				315 178 600 001		90	22.5	9.7	80	1700		315 109 300 113	01/11- OPR12530->	S	CAN	C	E	D	L1	V	105

Citroën C4 Picasso / Space Tourer auch für AdBlue	06/13-10/20			304 151 600 001		90	21.0	9.5	75	1750		315 196 300 113			S	CAN	C	E2	D	L1	V	75	
				304 152 600 001		90	24.0	9.5	75	1750													
	KIT			304 151 900 113		90	21.0	9.5	75	1750		im KIT enthalten 315 196 300 113			S	CAN	C	E2	D	L1	V	75	
	KIT			304 152 900 113		90	24.0	9.5	75	1750		im KIT enthalten 315 196 300 113			S	CAN	C	E2	D	L1	V	75	
Citroën C4 X Bitte prüfen, ob Anhängelast in den Fahrzeugpapieren eingetragen ist.	09/22-			304 216 600 001		90	25.0	7.1	61	1200		304 203 300 113	09/22-		S	A	C	E2	D1	L1	V	60	
Citroën C4 X Bitte prüfen, ob Anhängelast in den Fahrzeugpapieren eingetragen ist.	09/22-	KIT		304 216 900 113		90	26.6	7.1	61	1200		im KIT enthalten 304 203 300 113	09/22-		S	A	C	E2	D1	L1	V	60	
Citroën C5 Aircross nicht für Hybrid	11/18-			315 243 600 001		120	22.0	10.0	80	2000		304 204 300 113	11/18-		S	CAN	C	E	D1	L1	V	75	
				315 244 600 001		120	24.0	10.0	80	2000													
	KIT			304 213 900 113		120	23.5	10.0	80	2000		im KIT enthalten 304 204 300 113	11/18-		S	CAN	C	E	D1	L1	V	75	
	KIT			304 214 900 113		120	26.7	10.0	80	2000		im KIT enthalten 304 204 300 113	11/18-		S	CAN	C	E	D1	L1	V	75	
Citroën C5 Aircross Hybrid nur für Plugin-Hybrid	04/20-			314 599 600 001		90	26.7	8.1	95	1270													









Citroën















Citroën C5 Kombi	05/08-05/17		304 133 600 001		90	23.0	10.4	75	1900	304 400 300 113				S	CAN	C1	E	D	L1	H	105
			304 135 600 001		90	25.4	10.4	75	1900												
	KIT		304 146 900 113		120	29.0	10.4	80	1900	im KIT enthalten 304 400 300 113				S	CAN	C1	E	D	L1	H	105
	KIT		304 145 900 113		120	31.4	10.4	80	1900	im KIT enthalten 304 400 300 113											
Citroën C5 Limousine	05/08-05/17		304 133 600 001		90	23.0	10.4	75	1900	304 400 300 113				S	CAN	C1	E	D	L1	H	105
			304 135 600 001		90	25.4	10.4	75	1900												
	KIT		304 146 900 113		120	29.0	10.4	80	1900	im KIT enthalten 304 400 300 113				S	CAN	C1	E	D	L1	H	105
	KIT		304 145 900 113		120	31.4	10.4	80	1900	im KIT enthalten 304 400 300 113											
Citroën C5X ND_,NC_ auch für Plugin-Hybrid	09/21-		314 604 600 001		90	20.0	9.2	108	1650	314 602 300 113		09/21- auch für Plug-in Hybrid	S	CAN	C	E	D	L1	H	75	
			314 605 600 001		90	22.0	9.2	112	1650												
	KIT		314 604 900 113		90	22.0	9.2	108	1650	im KIT enthalten 314 602 300 113		09/21- auch für Plug-in Hybrid	S	CAN	C	E	D	L1	H	75	
	KIT		314 605 900 113		90	24.0	9.2	108	1650	im KIT enthalten 314 602 300 113											
Citroën DS4	04/11-10/15		304 148 600 001		60	19.0	9.2	75	1550	304 144 300 113				S	CAN	C	E	D	L	V	
		KIT		304 148 900 113		60	21.0	9.2	75	1550											im KIT enthalten 304 144 300 113



















Citroën DS5 nicht für Hybrid	02/12-07/15		304 149 600 001		120	29.0	8.5	75	1500	304 144 300 113		S	CAN	C	E	D	L	V	90	
Citroën Jumper Kasten/Kombi inkl. Kugelplatte	02/95-06/06		306 329 600 001		60	29.0	12.5	130	2000											
Citroën Jumper Kasten/Kombi Bei Kfz. mit langem Überhang L4/XL bitte einen Satz Distanzröhrchen zur Rahmenverstärkung mitbestellen, Art.-Nr. 906270650003. Bei Fahrzeugen 03/08- fehlen in der Karosserie werkseitig Bohrungen. Diese müssen nachträglich eingebracht werden. Die Montagezeit erhöht sich dadurch auf ca. 120 Min.	06/06-		306 491 600 001		120	32.0	16.9	150	3000	306 510 300 113	-02/11 bis Fg.-Nr. 1948840	S	FRE	--	E	D1	L1	V	105	
										306 553 300 113	02/11- ab Fg.- Nr. 1948841	S	FRE	--	E	D1	L1	V	105	
Citroën Jumper Kasten/Kombi inkl. Kugelplatte Bei Kfz. mit langem Überhang L4/XL bitte einen Satz Distanzröhrchen zur Rahmenverstärkung mitbestellen, Art.-Nr. 906270650003. Bei Fahrzeugen 03/08- fehlen in der Karosserie werkseitig Bohrungen. Diese müssen nachträglich eingebracht werden. Die Montagezeit erhöht sich dadurch auf ca. 120 Min.	06/06-		306 490 600 001		120	32.0	16.9	150	3000	306 510 300 113	-02/11 bis Fg.-Nr. 1948840	S	FRE	--	E	D1	L1	V	105	
										306 553 300 113	02/11- ab Fg.- Nr. 1948841	S	FRE	--	E	D1	L1	V	105	
Citroën Jumper Kasten/Kombi inkl. Kugelplatte Bei Fahrzeugen 03/08- fehlen in der Karosserie werkseitig Bohrungen. Diese müssen nachträglich eingebracht werden. Die Montagezeit erhöht sich dadurch auf ca. 120 Min.	06/06-		306 357 600 001	 	60	29.0	15.8	150	3000	306 510 300 113	-02/11 bis Fg.-Nr. 1948840	S	FRE	--	E	D1	L1	V	105	
										306 553 300 113	02/11- ab Fg.- Nr. 1948841	S	FRE	--	E	D1	L1	V	105	
Citroën Jumper Kasten/Kombi inkl. Kugelplatte für Fahrzeuge bis 6 m Länge 51 mm Vierkantaufnahme	06/06-		306 563 600 001		60	25.7	15.1	100	2500	306 510 300 113	-02/11 bis Fg.-Nr. 1948840	S	FRE	--	E	D1	L1	V	105	
										306 553 300 113	02/11- ab Fg.- Nr. 1948841	S	FRE	--	E	D1	L1	V	105	

Citroën











Citroën













<p>Citroën Jumper Kasten/Kombi Bei Kfz. mit langem Überhang L4/XL bitte einen Satz Distanzröhrchen zur Rahmenverstärkung mitbestellen, Art.-Nr. 906270650003. Bei Fahrzeugen 03/08- fehlen in der Karosserie werkseitig Bohrungen. Diese müssen nachträglich eingebracht werden. Die Montagezeit erhöht sich dadurch auf ca. 120 Min.</p>	06/06-02/11	KIT		306 271 900 113			120	34.0	16.9	150	3000		im KIT enthalten 306 510 300 113		-02/11 bis Fg.-Nr. 1948840	S	FRE	--	E	D1	L1	V	105
<p>Citroën Jumper Kasten/Kombi inkl. Kugelplatte Bei Kfz. mit langem Überhang L4/XL bitte einen Satz Distanzröhrchen zur Rahmenverstärkung mitbestellen, Art.-Nr. 906270650003. Bei Fahrzeugen 03/08- fehlen in der Karosserie werkseitig Bohrungen. Diese müssen nachträglich eingebracht werden. Die Montagezeit erhöht sich dadurch auf ca. 120 Min.</p>	06/06-02/11	KIT		306 330 900 113			120	34.0	16.9	150	3000		im KIT enthalten 306 510 300 113		-02/11 bis Fg.-Nr. 1948840	S	FRE	--	E	D1	L1	V	105
<p>Citroën Jumper Kasten/Kombi Bei Kfz. mit langem Überhang L4/XL bitte einen Satz Distanzröhrchen zur Rahmenverstärkung mitbestellen, Art.-Nr. 906270650003. Bei Fahrzeugen 03/08- fehlen in der Karosserie werkseitig Bohrungen. Diese müssen nachträglich eingebracht werden. Die Montagezeit erhöht sich dadurch auf ca. 120 Min.</p>	02/11-	KIT		306 491 900 113			120	32.8	16.9	150	3000		im KIT enthalten 306 553 300 113		02/11- ab Fg.- Nr. 1948841	S	FRE	--	E	D1	L1	V	105
<p>Citroën Jumper Kasten/Kombi inkl. Kugelplatte Bei Kfz. mit langem Überhang L4/XL bitte einen Satz Distanzröhrchen zur Rahmenverstärkung mitbestellen, Art.-Nr. 906270650003. Bei Fahrzeugen 03/08- fehlen in der Karosserie werkseitig Bohrungen. Diese müssen nachträglich eingebracht werden. Die Montagezeit erhöht sich dadurch auf ca. 120 Min.</p>	02/11-	KIT		306 490 900 113			120	32.2	16.9	150	3000		im KIT enthalten 306 553 300 113		02/11- ab Fg.- Nr. 1948841	S	FRE	--	E	D1	L1	V	105

Citroën Jumper Kasten/Kombi inkl. Kugelplatte Bei Fahrzeugen 03/08- fehlen in der Karosserie werkseitig Bohrungen. Diese müssen nachträglich eingebracht werden. Die Montagezeit erhöht sich dadurch auf ca. 120 Min.	02/11-	KIT		306 553 900 113	→ 	>150	31.0	15.8	150	3000		im KIT enthalten 306 553 300 113	02/11- ab Fg.- Nr. 1948841	S	FRE	--	E	D1	L1	V	105
Citroën Jumper Pritsche inkl. Kugelplatte	02/95-06/06			306 329 600 001	→	60	29.0	12.5	130	2000		300 052 300 113 300 060 300 113	03/02- -03/02	--	FRE	--	E1	D1	--	V	
Citroën Jumper Pritsche inkl. Kugelplatte Bei Kfz. mit langem Überhang L4/XL bitte einen Satz Distanzröhrchen zur Rahmenverstärkung mitbestellen, Art.-Nr. 906270650003.	06/06-			306 492 600 001		120	35.0	15.9	150	3000		306 531 300 113		S	FRE	--	E1	D	--	V	90
Citroën Jumper Pritsche inkl. Kugelplatte Bei Kfz. mit langem Überhang L4/XL bitte einen Satz Distanzröhrchen zur Rahmenverstärkung mitbestellen, Art.-Nr. 906270650003.	06/06-	KIT		306 318 900 113		120	37.0	15.9	150	3000		im KIT enthalten 306 531 300 113		S	FRE	--	E1	D	--	V	90
Citroën Jumper Pritsche inkl. Kugelplatte	06/06-			306 357 600 001	→ 	60	29.0	15.8	150	3000		306 531 300 113		S	FRE	--	E1	D	--	V	90
Citroën Jumper Wohnmobile keine Anhängerkupplung im Programm	06/06-											306 553 300 183		S	FRE	--	E1	D	L1	V	
Citroën Jumpy	01/07-06/16			306 331 600 001		75	22.5	12.2	122	2200		304 400 300 113	-06/16	S	CAN	C1	E	D	L1	H	105
				306 333 600 001		75	22.5	12.2	122	2200											
		KIT		306 331 900 113		75	22.5	12.2	122	2200		im KIT enthalten 304 400 300 113	-06/16	S	CAN	C1	E	D	L1	H	105
		KIT		306 333 900 113		75	24.5	12.2	122	2200		im KIT enthalten 304 400 300 113	-06/16	S	CAN	C1	E	D	L1	H	105





























Cupra Ateca KH7	09/18-			344 121 600 001		60	14.0	12.3	150	2500		305 407 300 113	für Fzg. mit Vorrüstung	S	CAN	C	E	D	L	H	30
				344 124 600 001		60	17.7	12.3	150	2500		305 408 300 107	→ für Fzg. ohne Vorrüstung	S	CAN	C	E	--	--	V	60
												305 408 300 113	für Fzg. ohne Vorrüstung	S	CAN	C	E	D	L	V	60
												305 438 300 113	inkl. WLC 2.0 für Fzg. ohne Vorrüstung	S	CAN	C	E	D	L1	V	90
												344 095 300 113	09/18- KH7 für Fzg. mit Vorrüstung und im Fahrzeug integriertem Anhänger-Steuergerät , für PR-Nr. 1M7	S	CAN	--	E	D	L	H	30
Cupra Ateca KH7 für Fzg. ohne Vorrüstung	09/18-	KIT		344 121 900 113		60	16.0	12.3	150	2500		im KIT enthalten 305 438 300 113	inkl. WLC 2.0 für Fzg. ohne Vorrüstung	S	CAN	C	E	D	L1	V	90
				344 124 900 113		60	19.6	12.3	150	2500		im KIT enthalten 305 438 300 113	inkl. WLC 2.0 für Fzg. ohne Vorrüstung	S	CAN	C	E	D	L1	V	90
Cupra Ateca KH7 für Fzg. mit Vorrüstung	09/18-	KIT		344 071 900 113		60	15.5	12.3	150	2500		im KIT enthalten 305 407 300 113	für Fzg. mit Vorrüstung	S	CAN	C	E	D	L	H	30
				344 072 900 113		60	19.2	12.3	150	2500		im KIT enthalten 305 407 300 113	für Fzg. mit Vorrüstung	S	CAN	C	E	D	L	H	30
Cupra Formentor KM7 nicht für VZ5	11/20-			344 121 600 001		60	14.0	12.3	150	2500		305 408 300 107	→ für Fzg. ohne Vorrüstung	S	CAN	C	E	--	--	V	60
				344 124 600 001		60	17.7	12.3	150	2500		305 408 300 113	für Fzg. ohne Vorrüstung	S	CAN	C	E	D	L	V	60
												344 095 300 113	11/20- KM7 für Fzg. mit Vorrüstung und im Fahrzeug integriertem Anhänger-Steuergerät , für PR-Nr. 1M7	S	CAN	--	E	D	L	H	30
Cupra Formentor KM7 für Fzg. ohne Vorrüstung nicht für VZ5	11/20-	KIT		344 121 900 113		60	16.0	12.3	150	2500		im KIT enthalten 305 438 300 113	inkl. WLC 2.0 für Fzg. ohne Vorrüstung	S	CAN	C	E	D	L1	V	90

Cupra

Cupra Formentor KM7 für Fzg. ohne Vorrüstung nicht für VZ5	11/20-	KIT		344 124 900 113		60	19.6	12.3	150	2500		im KIT enthalten 305 438 300 113	inkl. WLC 2.0 für Fzg. ohne Vorrüstung	S	CAN	C	E	D	L1	V	90
Cupra Leon IV KL1 auch für Hybrid Bitte prüfen, ob Anhängelast in den Fahrzeugpapieren eingetragen ist.	10/20-			305 605 600 001		60	19.4	9.0	109	2100		322 080 300 113	10/20- für Fzg. ohne Vorrüstung	S	CAN	C	E	D	L	V	120
												344 095 300 113	10/20- KL1 für Fzg. mit Vorrüstung und im Fahrzeug integriertem Anhängen- Steuergerät , für PR-Nr. 1M7	S	CAN	--	E	D	L	H	30
Cupra Leon IV KL1 auch für Hybrid Bitte prüfen, ob Anhängelast in den Fahrzeugpapieren eingetragen ist.	10/20-			305 606 600 001		60	21.4	9.0	109	2100		322 080 300 113	10/20- für Fzg. ohne Vorrüstung	S	CAN	C	E	D	L	V	120
												344 095 300 113	10/20- KL1 für Fzg. mit Vorrüstung und im Fahrzeug integriertem Anhängen- Steuergerät , für PR-Nr. 1M7	S	CAN	--	E	D	L	H	30
Cupra Leon IV Sportstouere KL8 auch für Hybrid	09/20-			305 605 600 001		60	19.4	9.0	109	2100		322 080 300 113	10/20- für Fzg. ohne Vorrüstung	S	CAN	C	E	D	L	V	120
												344 095 300 113	10/20- KL8 für Fzg. mit Vorrüstung und im Fahrzeug integriertem Anhängen- Steuergerät , für PR-Nr. 1M7	S	CAN	--	E	D	L	H	30
Cupra Leon IV Sportstouere KL8 auch für Hybrid AUFNAHMEROHR FÜR KUGELSTANGE SICHTBAR	09/20-			305 606 600 001		60	21.4	9.0	109	2100		322 080 300 113	10/20- für Fzg. ohne Vorrüstung	S	CAN	C	E	D	L	V	120
												344 095 300 113	10/20- KL8 für Fzg. mit Vorrüstung und im Fahrzeug integriertem Anhängen- Steuergerät , für PR-Nr. 1M7	S	CAN	--	E	D	L	H	30



DS 3 auch für Crossback Bitte prüfen, ob Anhängelast in den Fahrzeugpapieren eingetragen ist.	10/18-			304 216 600 001		90	25.0	7.1	61	1200		304 203 300 113	10/18-	S	A	C	E2	D1	L1	V	60
		KIT		304 216 900 113		90	26.6	7.1	61	1200		im KIT enthalten 304 203 300 113	10/18-	S	A	C	E2	D1	L1	V	60
DS 4	11/15-12/18			304 148 600 001		60	19.0	9.2	75	1550		304 144 300 113		S	CAN	C	E	D	L	V	90
		KIT		304 148 900 113		60	21.0	9.2	75	1550		im KIT enthalten 304 144 300 113		S	CAN	C	E	D	L	V	90
DS 4 Crossback				304 148 600 001		60	19.0	9.2	75	1550		304 144 300 113		S	CAN	C	E	D	L	V	90
		KIT		304 148 900 113		60	21.0	9.2	75	1550		im KIT enthalten 304 144 300 113		S	CAN	C	E	D	L	V	90
DS 5 nicht für Hybrid	08/15-05/19			304 149 600 001		120	29.0	8.5	75	1500		304 144 300 113		S	CAN	C	E	D	L	V	90

Dacia Jogger auch für Plug-in-Hybrid auch für LPG auch für Fzg. mit Reserverrad	03/22-		316 500 600 001		60	23.0	8.0	98	1400														
			316 501 600 001		60	24.0	8.0	98	1400														
Dacia Lodgy, J 92 5-/7-Sitzer auch für Stepway	06/12-02/22		316 324 600 001		45	19.5	8.1	75	1400			316 333 300 113		S	A	--	--	D1	L1	V	75		
			KIT		316 324 900 113		45	21.5	8.1	75	1400		im KIT enthalten 316 333 300 113		S	A	--	--	D1	L1	V	75	
Dacia Lodgy, J 92 5-/7-Sitzer nicht für Stepway	06/12-02/22		316 345 600 001		45	19.0	8.1	75	1400			316 333 300 113		S	A	--	--	D1	L1	V	75		
			KIT		316 345 900 113		45	21.0	8.1	75	1400		im KIT enthalten 316 333 300 113		S	A	--	--	D1	L1	V	75	
Dacia Logan Kombi / MCV I nicht für Kfz. mit Gasbetrieb nicht für Kfz. mit Einparkhilfe	01/07-06/13		316 259 600 001		60	22.6	7.7	75	1300		300 072 300 107	-12/07	--	FRE	--	--	--	--	V				
					300 072 300 113	-12/07	--	FRE	--	--	D1	L1	V										
					316 259 300 113	01/08-	S	C2	--	E1	D1	L1	V	45									
Dacia Logan Kombi / MCV I nicht für Kfz. mit Gasbetrieb nicht für Kfz. mit Einparkhilfe	01/08-06/13	KIT		316 259 900 113		60	24.6	7.7	75	1300		im KIT enthalten 316 259 300 113	01/08-	S	C2	--	E1	D1	L1	V	45		
Dacia Logan Kombi / MCV II auch für Stepway nicht für Fzg. mit nur 3 PDC Sensoren hinten	07/13-10/20		316 341 600 001		90	15.0	6.8	75	1150			316 338 300 113		S	A	--	--	D1	L1	H	60		
			KIT		316 341 900 113		90	16.0	6.8	75	1150		im KIT enthalten 316 338 300 113		S	A	--	--	D1	L1	H	60	
Dacia Logan Kombi / MCV II nicht für Stepway	07/13-10/20		316 342 600 001		90	18.0	6.8	75	1150			316 338 300 113		S	A	--	--	D1	L1	H	60		
			KIT		316 342 900 113		90	19.0	6.8	75	1150		im KIT enthalten 316 338 300 113		S	A	--	--	D1	L1	H	60	

Dacia Sandero II Stepway nicht für Kfz. mit GPL/Gasbetrieb	01/13-12/16	KIT		316 343 900 113		90	15.0	6.5	75	1100		im KIT enthalten 316 340 300 113	-12/16	S	A	--	--	D1	L1	H	60
		KIT		316 344 900 113		90	17.0	6.5	75	1100		im KIT enthalten 316 340 300 113	-12/16	S	A	--	--	D1	L1	H	60
Dacia Sandero II Stepway nicht für Kfz. mit GPL/Gasbetrieb	01/13-12/20			316 343 600 001		90	14.0	6.5	75	1100		316 340 300 113	-12/16	S	A	--	--	D1	L1	H	60
				316 344 600 001		90	16.0	6.5	75	1100		316 434 300 113	01/17-	S	A	--	E2	--	--	V	120
Dacia Sandero II Stepway nicht für Kfz. mit GPL/Gasbetrieb	01/17-12/20	KIT		316 434 900 113		90	17.5	6.5	75	1100		im KIT enthalten 316 434 300 113	01/17-	S	A	--	E2	D1	L1	V	120
		KIT		316 435 900 113		90	19.5	6.5	75	1100		im KIT enthalten 316 434 300 113	01/17-	S	A	--	E2	D1	L1	V	120
Dacia Sandero III nicht für LPG	01/21-			316 490 600 001		90	22.4	7.0	85	1100		316 482 300 113	01/21-	S	A	C1	E2	D	L1	V	60
				316 491 600 001		90	22.7	7.0	85	1100											
		KIT		316 490 900 113		90	22.3	7.0	85	1100		im KIT enthalten 316 482 300 113	01/21-	S	A	C1	E2	D	L1	V	60
		KIT		316 491 900 113		90	24.6	7.0	85	1100		im KIT enthalten 316 482 300 113	01/21-	S	A	C1	E2	D	L1	V	60
Dacia Sandero III Stepway nicht für LPG	01/21-			316 490 600 001		90	22.4	7.0	85	1100		316 482 300 113	01/21-	S	A	C1	E2	D	L1	V	60
				316 491 600 001		90	22.7	7.0	85	1100											
		KIT		316 490 900 113		90	22.3	7.0	85	1100		im KIT enthalten 316 482 300 113	01/21-	S	A	C1	E2	D	L1	V	60
		KIT		316 491 900 113		90	24.6	7.0	85	1100		im KIT enthalten 316 482 300 113	01/21-	S	A	C1	E2	D	L1	V	60

























Daihatsu











Daihatsu Charade	05/11-01/13			335 455 600 001		75	18.7	6.8	50	1150		335 383 300 113			S	FRE	--	--	D1	L1	V	120
		KIT		335 383 900 113		75	20.7	6.8	50	1150		im KIT enthalten 335 383 300 113			S	FRE	--	--	D1	L1	V	120

Dodge Journey, JC 49	01/08-12/20		342 199 600 001		90	15.8	9.6	80	1600	300 078 300 113				--	FRE	--	--	D1	L1	V		
Dodge Nitro auch für SXT mit 20" Reserverad, nicht für SRT	03/08-12/12		342 131 600 001		90	30.0	15.3	140	3500	300 210 300 113				--	A	--	E1	D1	L1	V	90	

Dodge













Fiat









Fiat 500 auch für Cabrio nicht für Abarth - 135 PS nicht für 500S nicht für ELECTRIC	07/07-			306 503 600 001		60	14.8	5.1	60	800		306 311 300 113	07/15-	S	FRE	--	E	D1	--	V	105
Fiat 500 auch für Cabrio nicht für Abarth - 135 PS nicht für ELECTRIC	07/07-			306 506 600 001		60	18.0	5.0	60	800		306 311 300 113	07/15-	S	FRE	--	E	D1	--	V	105
Fiat 500 auch für Cabrio nicht für Abarth - 135 PS nicht für 500S nicht für ELECTRIC	07/15-	KIT		306 503 900 113		60	15.9	5.1	60	800		im KIT enthalten 306 311 300 113	07/15-	S	FRE	--	E	D1	--	V	105
Fiat 500 auch für Cabrio nicht für Abarth - 135 PS nicht für ELECTRIC	07/15-	KIT		306 506 900 113		60	19.1	5.0	60	800		im KIT enthalten 306 311 300 113	07/15-	S	FRE	--	E	D1	--	V	105
Fiat 500 L auch für Trekking und Living nicht für Cross	10/12-06/17			306 401 600 001		60	18.0	7.5	90	1200		306 397 300 113		S	FRE	--	E	D1	L1	V	120
				306 400 600 001		60	21.0	7.5	90	1200											
		KIT		306 401 900 113		60	20.0	7.5	90	1200		im KIT enthalten 306 397 300 113		S	FRE	--	E	D1	L1	V	120
		KIT		306 400 900 113		60	23.0	7.5	90	1200		im KIT enthalten 306 397 300 113		S	FRE	--	E	D1	L1	V	120
Fiat 500 S auch für Cabrio nicht für Abarth - 135 PS	02/16-			306 505 600 001		60	15.0	5.0	60	800		306 311 300 113		S	FRE	--	E	D1	--	V	105
				306 506 600 001		60	18.0	5.0	60	800											
		KIT		306 505 900 113		60	16.0	5.0	60	800		im KIT enthalten 306 311 300 113		S	FRE	--	E	D1	--	V	105
		KIT		306 506 900 113		60	19.1	5.0	60	800		im KIT enthalten 306 311 300 113		S	FRE	--	E	D1	--	V	105

Fiat 500 X auch für Cross auch für AdBlue auch für Yacht Club nicht für Sport	09/14-			342 301 600 001		60	23.3	10.2	95	1900		306 527 300 113				S	FRE	--	E	D1	L1	V	120		
				342 302 600 001		60	26.3	10.2	95	1900															
		KIT		306 196 900 113		60	24.5	10.2	95	1900		im KIT enthalten 306 527 300 113						S	FRE	--	E	D1	L1	V	120
		KIT		306 197 900 113		60	28.3	10.2	95	1900		im KIT enthalten 306 527 300 113						S	FRE	--	E	D1	L1	V	120
Fiat Doblo Cargo WorkUp Pritschenwagen nicht für AdBlue	08/11-			306 393 600 001		90	28.0	9.3	100	1500		306 392 300 113				S	FRE	--	E1	D1	--	V	90		
Fiat Doblò II + Doblò II Cargo nicht für Kfz. mit Gasbetrieb (CNG) nicht für Kfz. mit Einparkhilfe	02/10-06/22			306 368 600 001		60	23.0	9.2	100	1500		306 605 300 113				S	FRE	--	E	D1	L1	V	90		
		KIT		306 368 900 113		45	25.0	9.2	100	1500		im KIT enthalten 306 605 300 113					S	FRE	--	E	D1	L1	V	90	
Fiat Doblò II + Doblò II Cargo nicht für Kfz. mit Gasbetrieb (CNG)	02/10-06/22			306 369 600 001		60	25.0	9.2	100	1500		306 605 300 113				S	FRE	--	E	D1	L1	V	90		
		KIT		306 369 900 113		60	27.0	9.2	100	1500		im KIT enthalten 306 605 300 113					S	FRE	--	E	D1	L1	V	90	
Fiat Doblò II + Doblò II Cargo inkl. Kugelplatte für Kfz. mit Gasbetrieb (CNG)	02/10-06/22			306 382 600 001		60	25.0	7.0	75	1000		306 605 300 113				S	FRE	--	E	D1	L1	V	90		
		KIT		306 382 900 113		60	27.0	7.0	75	1000		im KIT enthalten 306 605 300 113					S	FRE	--	E	D1	L1	V	90	



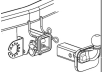







Fiat





















Fiat

Fiat Doblò L1 510, 511 auch für E-Doblò	06/22-	 304 207 600 001	 304 209 600 001			60	20.0	8.6	75	1500		314 594 300 113		06/22-Doblò	auch für E-	S	A	C	E	D	L	V	90	
						60	20.5	8.6	75	1500														
		KIT	 304 207 900 113					60	21.2	8.6	75	1500	im KIT enthalten 314 594 300 113		06/22-Doblò	auch für E-	S	A	C	E	D	L	V	90
								KIT	 304 209 900 113									60	21.8	8.6	75	1500	im KIT enthalten 314 594 300 113	
Fiat Doblò L2 510, 511 auch für E-Doblò	06/22-	 304 210 600 001	 304 212 600 001			60	21.0	8.6	75	1500		314 594 300 113		06/22-Doblò	auch für E-	S	A	C	E	D	L	V	90	
						60	21.5	8.6	75	1500														
		KIT	 304 210 900 113					60	22.2	8.6	75	1500	im KIT enthalten 314 594 300 113		06/22-Doblò	auch für E-	S	A	C	E	D	L	V	90
								KIT	 304 212 900 113									60	22.8	8.6	75	1500	im KIT enthalten 314 594 300 113	
Fiat Ducato Kasten/Kombi inkl. Kugelplatte	02/95-06/06	 306 329 600 001				60	29.0	12.5	130	2000														
Fiat Ducato Kasten/Kombi Bei Kfz. mit langem Überhang L4/XL bitte einen Satz Distanzröhrchen zur Rahmenverstärkung mitbestellen, Art.-Nr. 906270650003. Bei Fahrzeugen 03/08- fehlen in der Karosserie werkseitig Bohrungen. Diese müssen nachträglich eingebracht werden. Die Montagezeit erhöht sich dadurch auf ca. 120 Min.	06/06-	 306 491 600 001				120	32.0	16.9	150	3000		306 510 300 113		-02/11 bis Fg.-Nr. 1948840	S	FRE	--	E	D1	L1	V	105		
						306 553 300 113	02/11- ab Fg.-Nr. 1948841	S	FRE	--		E		D1	L1	V	105							

Fiat Ducato Kasten/Kombi inkl. Kugelplatte Bei Kfz. mit langem Überhang L4/XL bitte einen Satz Distanzröhrchen zur Rahmenverstärkung mitbestellen, Art.-Nr. 906270650003. Bei Fahrzeugen 03/08- fehlen in der Karosserie werkseitig Bohrungen. Diese müssen nachträglich eingebracht werden. Die Montagezeit erhöht sich dadurch auf ca. 120 Min.	06/06-			306 490 600 001			120	32.0	16.9	150	3000		306 510 300 113		-02/11 bis Fg.-Nr. 1948840	S	FRE	--	E	D1	L1	V	105
													306 553 300 113		02/11- ab Fg.- Nr. 1948841	S	FRE	--	E	D1	L1	V	105
Fiat Ducato Kasten/Kombi inkl. Kugelplatte Bei Fahrzeugen 03/08- fehlen in der Karosserie werkseitig Bohrungen. Diese müssen nachträglich eingebracht werden. Die Montagezeit erhöht sich dadurch auf ca. 120 Min.	06/06-			306 357 600 001		 	60	29.0	15.8	150	3000		306 510 300 113		-02/11 bis Fg.-Nr. 1948840	S	FRE	--	E	D1	L1	V	105
													306 553 300 113		02/11- ab Fg.- Nr. 1948841	S	FRE	--	E	D1	L1	V	105
Fiat Ducato Kasten/Kombi inkl. Kugelplatte für Fahrzeuge bis 6 m Länge 51 mm Vierkantaufnahme	06/06-			306 563 600 001			60	25.7	15.1	100	2500		306 510 300 113		-02/11 bis Fg.-Nr. 1948840	S	FRE	--	E	D1	L1	V	105
													306 553 300 113		02/11- ab Fg.- Nr. 1948841	S	FRE	--	E	D1	L1	V	105
Fiat Ducato Kasten/Kombi Bei Kfz. mit langem Überhang L4/XL bitte einen Satz Distanzröhrchen zur Rahmenverstärkung mitbestellen, Art.-Nr. 906270650003. Bei Fahrzeugen 03/08- fehlen in der Karosserie werkseitig Bohrungen. Diese müssen nachträglich eingebracht werden. Die Montagezeit erhöht sich dadurch auf ca. 120 Min.	06/06-02/11	KIT		306 271 900 113			120	34.0	16.9	150	3000		im KIT enthalten 306 510 300 113		-02/11 bis Fg.-Nr. 1948840	S	FRE	--	E	D1	L1	V	105
Fiat Ducato Kasten/Kombi inkl. Kugelplatte Bei Kfz. mit langem Überhang L4/XL bitte einen Satz Distanzröhrchen zur Rahmenverstärkung mitbestellen, Art.-Nr. 906270650003. Bei Fahrzeugen 03/08- fehlen in der Karosserie werkseitig Bohrungen. Diese müssen nachträglich eingebracht werden. Die Montagezeit erhöht sich dadurch auf ca. 120 Min.	06/06-02/11	KIT		306 330 900 113			120	34.0	16.9	150	3000		im KIT enthalten 306 510 300 113		-02/11 bis Fg.-Nr. 1948840	S	FRE	--	E	D1	L1	V	105























Fiat























Fiat Ducato Kasten/Kombi Bei Kfz. mit langem Überhang L4/XL bitte einen Satz Distanzröhrchen zur Rahmenverstärkung mitbestellen, Art.-Nr. 906270650003. Bei Fahrzeugen 03/08- fehlen in der Karosserie werkseitig Bohrungen. Diese müssen nachträglich eingebracht werden. Die Montagezeit erhöht sich dadurch auf ca. 120 Min.	02/11-	KIT		306 491 900 113		120	32.8	16.9	150	3000				im KIT enthalten 306 553 300 113		02/11- 1948841	ab Fg.- Nr.	S	FRE	--	E	D1	L1	V	105
Fiat Ducato Kasten/Kombi inkl. Kugelplatte Bei Kfz. mit langem Überhang L4/XL bitte einen Satz Distanzröhrchen zur Rahmenverstärkung mitbestellen, Art.-Nr. 906270650003. Bei Fahrzeugen 03/08- fehlen in der Karosserie werkseitig Bohrungen. Diese müssen nachträglich eingebracht werden. Die Montagezeit erhöht sich dadurch auf ca. 120 Min.	02/11-	KIT		306 490 900 113		120	32.2	16.9	150	3000				im KIT enthalten 306 553 300 113		02/11- 1948841	ab Fg.- Nr.	S	FRE	--	E	D1	L1	V	105
Fiat Ducato Kasten/Kombi inkl. Kugelplatte Bei Fahrzeugen 03/08- fehlen in der Karosserie werkseitig Bohrungen. Diese müssen nachträglich eingebracht werden. Die Montagezeit erhöht sich dadurch auf ca. 120 Min.	02/11-	KIT		306 553 900 113	→ 	>150	31.0	15.8	150	3000				im KIT enthalten 306 553 300 113		02/11- 1948841	ab Fg.- Nr.	S	FRE	--	E	D1	L1	V	105
Fiat Ducato Pritsche inkl. Kugelplatte	02/95-06/06			306 329 600 001	→	60	29.0	12.5	130	2000			300 052 300 113 300 060 300 113		03/02- 03/02-	--	FRE	--	E1	D1	--	V			
Fiat Ducato Pritsche inkl. Kugelplatte Bei Kfz. mit langem Überhang L4/XL bitte einen Satz Distanzröhrchen zur Rahmenverstärkung mitbestellen, Art.-Nr. 906270650003.	06/06-			306 492 600 001		120	35.0	15.9	150	3000			306 531 300 113			S	FRE	--	E1	D	--	V	90		
Fiat Ducato Pritsche inkl. Kugelplatte Bei Kfz. mit langem Überhang L4/XL bitte einen Satz Distanzröhrchen zur Rahmenverstärkung mitbestellen, Art.-Nr. 906270650003.	06/06-	KIT		306 318 900 113		120	37.0	15.9	150	3000			im KIT enthalten 306 531 300 113			S	FRE	--	E1	D	--	V	90		
Fiat Ducato Pritsche inkl. Kugelplatte	06/06-			306 357 600 001	→ 	60	29.0	15.8	150	3000			306 531 300 113			S	FRE	--	E1	D	--	V	90		

Fiat Ducato Wohnmobile keine Anhängerkupplung im Programm													306 553 300 183			S	FRE	--	E1	D	L1	V				
Fiat E-Ulysse	03/22-			304 190 600 001			45	26.0	13.9	104	2500					S	FRE									
				335 106 600 001			60	25.5	13.9	104	2500		314 585 300 113		für Fzg. ohne Vorrüstung, inkl. WLC 2.0	S	FRE	C	E	D	L1	H	75			
Fiat E-Ulysse für Fzg. ohne Vorrüstung	03/22-	KIT		314 576 900 113			45	27.7	13.9	104	2500		im KIT enthalten 314 585 300 113		für Fzg. ohne Vorrüstung, inkl. WLC 2.0	S	FRE	C	E	D	L1	H	75			
		KIT		314 578 900 113			60	27.2	13.9	104	2500		im KIT enthalten 314 585 300 113		für Fzg. ohne Vorrüstung, inkl. WLC 2.0	S	FRE	C	E	D	L1	H	75			
Fiat Fiorino Kasten / Kombi / Qubo (225) nicht für Kfz. mit Gasbetrieb	02/08-			306 349 600 001			150	16.5	7.5	75	1300		306 580 300 113			S	FRE	--	E	D1	L1	V	120			
		KIT		306 349 900 113			150	18.5	7.5	75	1300		im KIT enthalten 306 580 300 113			S	FRE	--	E	D1	L1	V	120			
Fiat Fiorino Kasten / Kombi / Qubo (225) inkl. Kugelplatte nicht für Kfz. mit Gasbetrieb	02/08-			306 351 600 001			150	17.0	7.5	75	1300		306 580 300 113			S	FRE	--	E	D1	L1	V	120			
Fiat Freemont nicht für Freemont Cross	09/11-12/16			342 199 600 001			90	15.8	9.6	80	1600		300 078 300 113			--	FRE	--	--	D1	L1	V				
Fiat Fullback Double Cab inkl. Kugelplatte	06/16-07/20			340 124 600 001			60	31.5	14.7	125	3100		340 136 300 107			S	C2	--	--	--	--	V	90			
Fiat Grande Punto	10/05-10/09			306 375 600 001			90	19.0	6.7	75	1100							FRE	--	--	D1	L1	V			
				306 374 600 001			90	19.0	6.7	75	1100		300 078 300 113		10/05-10/09	--	FRE	--	--	D1	L1	V				
Fiat Panda Frontantrieb nicht für Fzg. mit Gasbetrieb (LPG/CNG)	02/12-			306 385 600 001			60	19.0	6.1	70	1000		306 394 300 113			S	FRE	--	E	D1	--	V	105			

Fiat



















Fiat







Fiat Panda Frontantrieb nicht für Fzg. mit Gasbetrieb (LPG/CNG)	02/12-			306 394 600 001	→ 	60	19.5	6.1	70	1000		306 394 300 113			S	FRE	--	E	D1	--	V	105
		KIT		306 385 900 113		60	21.0	6.1	70	1000		im KIT enthalten 306 394 300 113			S	FRE	--	E	D1	--	V	105
		KIT		306 394 900 113	→ 	60	21.5	6.1	70	1000		im KIT enthalten 306 394 300 113			S	FRE	--	E	D1	--	V	105
Fiat Panda 4x4 auch für Trekking nicht für Fzg. mit Gasbetrieb (LPG/CNG)	10/12-05/22			306 388 600 001		60	18.0	5.8	60	900		306 394 300 113	-05/22	S	FRE	--	E	D1	--	V	105	
				306 389 600 001		60	19.5	5.8	60	900												
		KIT		306 388 900 113		60	21.0	5.8	60	900		im KIT enthalten 306 394 300 113	-05/22	S	FRE	--	E	D1	--	V	105	
		KIT		306 389 900 113		60	22.0	5.8	60	900		im KIT enthalten 306 394 300 113	-05/22	S	FRE	--	E	D1	--	V	105	
Fiat Panda Cross Kfz. mit Gasbetrieb sind nicht für den Anhängerbetrieb zugelassen.	10/14-			306 388 600 001		60	18.0	5.8	60	900		306 394 300 113		S	FRE	--	E	D1	--	V	105	
				306 389 600 001		60	19.5	5.8	60	900												
		KIT		306 388 900 113		60	21.0	5.8	60	900		im KIT enthalten 306 394 300 113		S	FRE	--	E	D1	--	V	105	
		KIT		306 389 900 113		60	22.0	5.8	60	900		im KIT enthalten 306 394 300 113		S	FRE	--	E	D1	--	V	105	

Fiat Punto EVO	10/09-08/18			306 375 600 001		90	19.0	6.7	75	1100		300 078 300 113	10/09-08/18	--	FRE	--	--	D1	L1	V			
				306 374 600 001		90	19.0	6.7	75	1100		306 375 300 113		S	CAN	--	E	D	--	V	105		
		KIT		306 375 900 113		90	21.0	6.7	75	1100		im KIT enthalten 306 375 300 113		S	CAN	--	E	D	--	V	105		
		KIT		306 374 900 113		90	21.0	6.7	75	1100		im KIT enthalten 306 375 300 113		S	CAN	--	E	D	--	V	105		
Fiat Qubo / Qubo Trekking (225) nicht für Kfz. mit Gasbetrieb	02/08-			306 349 600 001		150	16.5	7.5	75	1300		306 580 300 113		S	FRE	--	E	D1	L1	V	120		
		KIT		306 349 900 113		150	18.5	7.5	75	1300		im KIT enthalten 306 580 300 113		S	FRE	--	E	D1	L1	V	120		
Fiat Qubo / Qubo Trekking (225) inkl. Kugelplatte nicht für Kfz. mit Gasbetrieb	02/08-			306 351 600 001		150	17.0	7.5	75	1300		306 580 300 113		S	FRE	--	E	D1	L1	V	120		
Fiat Scudo	01/07-06/16			306 331 600 001		75	22.5	12.2	122	2200		304 400 300 113		S	CAN	C1	E	D	L1	H	105		
				306 333 600 001		75	22.5	12.2	122	2200													
		KIT		306 331 900 113		75	22.5	12.2	122	2200		im KIT enthalten 304 400 300 113		S	CAN	C1	E	D	L1	H	105		
		KIT		306 333 900 113		75	24.5	12.2	122	2200		im KIT enthalten 304 400 300 113		S	CAN	C1	E	D	L1	H	105		





















Fiat













Fiat

Fiat Scudo III auch für E-Scudo	12/21-			304 190 600 001			45	26.0	13.9	104	2500												
				335 106 600 001			60	25.5	13.9	104	2500												
	KIT		314 576 900 113			45	27.7	13.9	104	2500	im KIT enthalten	314 585 300 113		S	FRE	C	E	D	L1	H	75		
	KIT		314 578 900 113			60	27.2	13.9	104	2500	im KIT enthalten	314 585 300 113		S	FRE	C	E	D	L1	H	75		
Fiat Tipo Cross Kombi Bitte zusätzlich bestellen: Verlängerung für Steckdosenhalter, Art. Nr. 921740650001	04/21-			306 407 600 001			90	21.0	9.0	60	1500	306 470 300 113		04/21- für Fzg. mit LED- Rückleuchten	S	FRE	--	--	D1	L1	V	120	
Fiat Tipo Cross Kombi für Fzg. mit LED-Rückleuchten Bitte zusätzlich bestellen: Verlängerung für Steckdosenhalter, Art. Nr. 921740650001	04/21-	KIT		306 409 900 113			90	25.9	9.0	60	1500	im KIT enthalten	306 470 300 113		04/21- für Fzg. mit LED- Rückleuchten	S	FRE	--	--	D1	L1	V	120
Fiat Tipo Cross Schrägheck / Hatchback nicht für Tipo Sport	04/21-			306 405 600 001			90	22.0	8.7	60	1200	306 470 300 113		für Fzg. mit LED- Rückleuchten	S	FRE	--	--	D1	L1	V	120	
Fiat Tipo Cross Schrägheck / Hatchback nicht für Tipo Sport für Fzg. mit LED Rückleuchten	04/21-	KIT		306 408 900 113			90	24.2	8.7	60	1200	im KIT enthalten	306 470 300 113		für Fzg. mit LED- Rückleuchten	S	FRE	--	--	D1	L1	V	120
Fiat Tipo Kombi / sw nicht für Cross	09/16-			306 407 600 001			90	21.0	9.0	60	1500	306 469 300 113		nicht für Fzg. mit LED-Rückleuchten	S	FRE	--	E	D1	L1	V	120	
												306 470 300 113		04/21- für Fzg. mit LED- Rückleuchten	S	FRE	--	--	D1	L1	V	120	
Fiat Tipo Kombi / sw nicht für Fzg. mit LED- Rückleuchten nicht für Cross	09/16-	KIT		306 407 900 113			90	22.3	9.0	60	1500	im KIT enthalten	306 469 300 113		nicht für Fzg. mit LED-Rückleuchten	S	FRE	--	E	D1	L1	V	120
Fiat Tipo Kombi / sw nicht für Cross für Fzg. mit LED-Rückleuchten	04/21-	KIT		306 409 900 113			90	25.9	9.0	60	1500	im KIT enthalten	306 470 300 113		04/21- für Fzg. mit LED- Rückleuchten	S	FRE	--	--	D1	L1	V	120



























Fiat Tipo Schrägheck / Hatchback nicht für Tipo Sport	09/16-			306 405 600 001		90	22.0	8.7	60	1200		306 469 300 113	nicht für Fzg. mit LED-Rückleuchten	S	FRE	--	E	D1	L1	V	120
												306 470 300 113									
Fiat Tipo Schrägheck / Hatchback nicht für Tipo Sport nicht für Fzg. mit LED-Rückleuchten	09/16-	KIT		306 405 900 113		90	23.3	8.7	60	1500		im KIT enthalten 306 469 300 113	nicht für Fzg. mit LED-Rückleuchten	S	FRE	--	E	D1	L1	V	120
Fiat Tipo Schrägheck / Hatchback nicht für Tipo Sport für Fzg. mit LED-Rückleuchten	04/21-	KIT		306 408 900 113		90	24.2	8.7	60	1200		im KIT enthalten 306 470 300 113	04/21- für Fzg. mit LED-Rückleuchten	S	FRE	--	--	D1	L1	V	120























Ford

Ford B-Max	09/12-09/17			307 333 600 001			70	19.5	6.8	65	900		307 397 300 107			S	A	--	E	--	--	V	60
Ford B-Max nicht für Kfz. mit Einparkhilfe	09/12-09/17			307 397 600 001			70	18.5	6.8	65	900		307 397 300 107			S	A	--	E	--	--	V	60
Ford C-Max für Fzg. ohne Vorrüstung	09/10-06/19	KIT		307 402 900 113			60	21.0	10.0	90	1800		im KIT enthalten 307 402 300 113		bei Fzg. ohne Vorrüstung Anschluss vorn	S	CAN	C	E	D	L1	H	45
Ford C-Max für Fzg. ohne Vorrüstung	09/10-06/19	KIT		307 441 900 113			60	23.0	10.0	90	1800		im KIT enthalten 307 402 300 113		bei Fzg. ohne Vorrüstung Anschluss vorn	S	CAN	C	E	D	L1	H	45
Ford C-Max	09/10-06/19			307 508 600 001			60	19.2	10.0	90	1800		307 402 300 107		bei Fzg. ohne Vorrüstung Anschluss vorn	S	CAN	C	E	--	--	H	45
				307 507 600 001			60	25.0	10.0	90	1800		307 402 300 113		bei Fzg. ohne Vorrüstung Anschluss vorn	S	CAN	C	E	D	L1	H	45
													307 539 300 113		06/15- für Fzg. mit Vorrüstung	S	FRE	C	E2	D	L1	H	90
Ford C-Max für Fzg. mit Vorrüstung	06/15-06/19	KIT		307 508 900 113			60	23.0	10.0	90	1800		im KIT enthalten 307 539 300 113		06/15- für Fzg. mit Vorrüstung	S	FRE	C	E2	D	L1	H	90
		KIT		307 507 900 113			60	29.0	10.0	90	1800		im KIT enthalten 307 539 300 113		06/15- für Fzg. mit Vorrüstung	S	FRE	C	E2	D	L1	H	90
Ford Ecosport nicht für Allrad nur für Fzg. mit Gewindebohrungen im Fahrzeugrahmen	10/17-12/22			307 636 600 001			60	21.7	7.0	80	1100		307 489 300 113		10/17- für Fzg mit Vorrüstung, inkl. WLC 2.0	S	FRE	C	E2	D	L1	H	60
				307 637 600 001			60	24.8	7.0	80	1100												
Ford Ecosport für Fzg. mit Vorrüstung nicht für Allrad nur für Fzg. mit Gewindebohrungen im Fahrzeugrahmen	10/17-12/22	KIT		307 636 900 113			60	23.3	7.0	80	1100		im KIT enthalten 307 489 300 113		10/17- für Fzg mit Vorrüstung, inkl. WLC 2.0	S	FRE	C	E2	D	L1	H	60
		KIT		307 637 900 113			60	26.4	7.0	80	1100		im KIT enthalten 307 489 300 113		10/17- für Fzg mit Vorrüstung, inkl. WLC 2.0	S	FRE	C	E2	D	L1	H	60



















Ford Edge	07/16-			307 495 600 001			90	28.5	11.6	90	2200		307 495 300 113			S	CAN	C	E	D	L1	H	45		
		KIT		307 495 900 113			90	30.9	11.6	90	2200		im KIT enthalten 307 495 300 113			S	CAN	C	E	D	L1	H	45		
Ford Fiesta nicht für ST / 150 PS Bitte prüfen, ob Anhängelast in den Fahrzeugpapieren eingetragen ist.	04/02-10/08			307 283 600 001			75	13.7	6.3	75	1050		300 072 300 107	-10/05	--	FRE	--	--	--	--	V				
													300 072 300 113	-10/05	--	FRE	--	--	D1	L1	V				
														307 122 300 113	11/05-	S	FRE	--	E	D1	L	V	90		
Ford Fiesta nicht für ST / 150 PS Bitte prüfen, ob Anhängelast in den Fahrzeugpapieren eingetragen ist.	11/05-10/08	KIT		307 283 900 113			75	15.7	6.3	75	1050		im KIT enthalten 307 122 300 113	11/05-	S	FRE	--	E	D1	L	V	90			
Ford Fiesta nicht für Titanium, Sport, Zetec S auch für Fiesta Van 2011-	10/08-06/17			307 363 600 001			90	14.0	6.5	50	1100														
				307 330 600 001			90	17.0	6.5	50	1100		307 123 300 113	02/13-06/17	S	FRE	--	--	D1	L1	H	60			
Ford Fiesta nicht für Titanium, Sport, Zetec S auch für Fiesta Van 2011-	02/13-06/17	KIT		307 365 900 113			90	14.0	6.5	50	1100		im KIT enthalten 307 123 300 113	02/13-06/17	S	FRE	--	--	D1	L1	H	60			
		KIT		307 341 900 113			90	19.0	6.5	50	1100		im KIT enthalten 307 123 300 113	02/13-06/17	S	FRE	--	--	D1	L1	H	60			
Ford Fiesta MK8 Fahrzeuge mit elektrischen Panorama-Schiebedach: Anhängerkupplung nur für Modelle mit 1,1-l-Motoren	07/17-07/23			307 658 600 001			75	19.6	6.1	65	1000		307 599 300 113	07/17-07/23 inkl. WLC 2.0	S	A	C1	E2	D1	L1	V	90			
				307 659 600 001			75	22.4	6.1	65	1000														
		KIT		307 599 900 113			75	21.4	6.1	65	1000		im KIT enthalten 307 599 300 113	07/17-07/23 inkl. WLC 2.0	S	A	C1	E2	D1	L1	V	90			
		KIT		307 600 900 113			75	24.2	6.1	65	1000		im KIT enthalten 307 599 300 113	07/17-07/23 inkl. WLC 2.0	S	A	C1	E2	D1	L1	V	90			























Ford

Ford Fiesta ST-Line MK8 Fahrzeuge mit elektrischen Panorama-Schiebedach: Anhängerkupplung nur für Modelle mit 1,1-l-Motoren	07/17-07/23			307 658 600 001		75	19.6	6.1	65	1000		307 599 300 113	07/17-	S	A	C1	E2	D1	L1	V	90
				307 659 600 001		75	22.4	6.1	65	1000											
		KIT		307 599 900 113		75	21.4	6.1	65	1000		im KIT enthalten 307 599 300 113	07/17-	S	A	C1	E2	D1	L1	V	90
		KIT		307 600 900 113		75	24.2	6.1	65	1000		im KIT enthalten 307 599 300 113	07/17-	S	A	C1	E2	D1	L1	V	90
Ford Fiesta Van nicht für ST / 150 PS	07-12/10			307 283 600 001		75	13.7	6.3	75	1050		307 122 300 113		S	FRE	--	E	D1	L	V	90
			KIT		307 283 900 113		75	15.7	6.3	75	1050										
Ford Focus C-Max Van	10/03-11/10			307 264 600 001		120	21.0	8.7	75	1590		307 264 300 113		S	FRE	--	E	D1	--	H	45
				343 038 600 001		90	21.5	8.7	75	1590											
		KIT		307 438 900 113		120	23.0	8.7	75	1590		im KIT enthalten 307 264 300 113		S	FRE	--	E	D1	--	H	45
		KIT		307 407 900 113		90	22.5	8.7	75	1590		im KIT enthalten 307 264 300 113		S	FRE	--	E	D1	--	H	45
Ford Focus Cabrio auch für CC-3 und CC3D Turbo Modelle	04/07-09/10			343 038 600 001		90	21.5	8.7	75	1590		300 072 300 107 300 072 300 113		--	FRE	--	--	--	--	V	
Ford Focus Schrägheck nicht für ST / 225 PS, nicht für RS/ 300 PS	10/04-01/08	KIT		307 454 900 113	→ 	120	23.0	8.7	75	1590		im KIT enthalten 307 231 300 113	→ -01/08	S	FRE	--	E	D1	--	H	60
		KIT		307 453 900 113	→ 	120	23.5	8.7	75	1590		im KIT enthalten 307 231 300 113	→ -01/08	S	FRE	--	E	D1	--	H	60















Ford Focus Schrägheck nicht für ST / 225 PS, nicht für RS/ 300 PS auch für Modelle 01/08-	10/04-03/11			307 264 600 001		120	21.0	8.7	75	1590		307 231 300 113		-01/08	S	FRE	--	E	D1	--	H	60	
				343 038 600 001			90	21.5	8.7	75													1590
Ford Focus Schrägheck 06/12-: Bei Fahrzeugen mit 1,0 GTDi-Motor muss bei Montage der Anhängerkupplung ggfs. eine Zusatzwasserpumpe nachgerüstet werden. Einzelheiten sind in der TSB 35/2012 aufgeführt. nicht für EcoBoost S / Individual Styling Paket auch für Facelift 11/2014-	03/11-08/18			307 459 600 001		60	21.0	10.0	90	1500		307 402 300 107		bei Fzg. ohne Vorrüstung Anschluss vorn	S	CAN	C	E	--	--	H	45	
				307 461 600 001			60	21.0	9.5	90				1500	307 402 300 113	bei Fzg. ohne Vorrüstung Anschluss vorn	S	CAN	C	E	D	L1	H
Ford Focus Schrägheck für Fzg. ohne Vorrüstung 06/12-: Bei Fahrzeugen mit 1,0 GTDi-Motor muss bei Montage der Anhängerkupplung ggfs. eine Zusatzwasserpumpe nachgerüstet werden. Einzelheiten sind in der TSB 35/2012 aufgeführt. nicht für EcoBoost S / Individual Styling Paket auch für Facelift 11/2014-	03/11-08/18	KIT		307 459 900 113		60	23.0	10.0	75	1500		im KIT enthalten 307 402 300 113		bei Fzg. ohne Vorrüstung Anschluss vorn	S	CAN	C	E	D	L1	H	45	
				307 461 900 113			60	23.0	10.0	75				1500	im KIT enthalten 307 402 300 113	bei Fzg. ohne Vorrüstung Anschluss vorn	S	CAN	C	E	D	L1	H
Ford Focus Schrägheck HN 5-Türer auch für ST-Line auch für Activ	09/18-			307 652 600 001			60	21.7	9.5	90	1800		307 489 300 113		09/18- für Fzg. mit Vorrüstung, inkl. WLC 2.0	S	FRE	C	E2	D	L1	H	60
				307 653 600 001			60	24.7	9.5	90	1800				307 490 300 113	09/18- für Fzg. ohne Vorrüstung, inkl. WLC 2.0	S	CAN	C	E	D	L1	V
Ford Focus Schrägheck HN für Fzg. ohne Vorrüstung 5-Türer auch für ST-Line auch für Activ	09/18-	KIT		307 652 900 113			60	23.4	9.5	90	1800		im KIT enthalten 307 490 300 113		09/18- für Fzg. ohne Vorrüstung, inkl. WLC 2.0	S	CAN	C	E	D	L1	V	75
				307 653 900 113			60	26.4	9.5	90	1800				im KIT enthalten 307 490 300 113	09/18- für Fzg. ohne Vorrüstung, inkl. WLC 2.0	S	CAN	C	E	D	L1	V
Ford Focus Schrägheck Active HP 5-Türer	01/19-			307 652 600 001			60	21.7	9.5	90	1800		307 489 300 113		01/19- für Fzg. mit Vorrüstung, inkl. WLC 2.0	S	FRE	C	E2	D	L1	H	60
				307 653 600 001			60	24.7	9.5	90	1800				307 490 300 113	01/19- für Fzg. ohne Vorrüstung, inkl. WLC 2.0	S	CAN	C	E	D	L1	V

























Ford

Ford Focus Schrägheck Active HP für Fzg. ohne Vorrüstung 5-Türer	01/19-	KIT		307 652 900 113		60	23.4	9.5	90	1800		im KIT enthalten 307 490 300 113	01/19- für Fzg. ohne Vorrüstung, inkl. WLC 2.0	S	CAN	C	E	D	L1	V	75
		KIT		307 653 900 113		60	26.4	9.5	90	1800		im KIT enthalten 307 490 300 113	01/19- für Fzg. ohne Vorrüstung, inkl. WLC 2.0	S	CAN	C	E	D	L1	V	75
Ford Focus Turnier nicht für ST / 225 PS	03/05-04/11			307 337 600 001		150	20.5	8.5	75	1500		300 072 300 113	für Fzg. ohne Zentralsteckverbindung	--	FRE	--	--	D1	L1	V	
Ford Focus Turnier nicht für ST / 225 PS Schaumteil zur Befestigung der Antenne für Kfz. mit Keyless-Entry, Art.-Nr. 907456630001 06/12-: Bei Fahrzeugen mit 1,0 GTDi-Motor muss bei Montage der Anhängerkupplung ggfs. eine Zusatzwasserpumpe nachgerüstet werden. Einzelheiten sind in der TSB 35/2012 aufgeführt. Nicht für EcoBoost S / Individual Styling Paket auch für Facelift 11/2014-	04/11-08/18			307 456 600 001		90	23.0	10.0	90	1500		307 402 300 107	bei Fzg. ohne Vorrüstung Anschluss vorn	S	CAN	C	E	--	--	H	45
				307 458 600 001		90	24.0	10.0	90	1500		307 402 300 113	bei Fzg. ohne Vorrüstung Anschluss vorn	S	CAN	C	E	D	L1	H	45
Ford Focus Turnier für Fzg. ohne Vorrüstung nicht für ST / 225 PS Schaumteil zur Befestigung der Antenne für Kfz. mit Keyless-Entry, Art.-Nr. 907456630001 06/12-: Bei Fahrzeugen mit 1,0 GTDi-Motor muss bei Montage der Anhängerkupplung ggfs. eine Zusatzwasserpumpe nachgerüstet werden. Einzelheiten sind in der TSB 35/2012 aufgeführt. Nicht für EcoBoost S / Individual Styling Paket auch für Facelift 11/2014-	04/11-08/18	KIT		307 456 900 113		90	25.0	10.0	90	1500		im KIT enthalten 307 402 300 113	bei Fzg. ohne Vorrüstung Anschluss vorn	S	CAN	C	E	D	L1	H	45
		KIT		307 458 900 113		90	26.0	10.0	90	1500		im KIT enthalten 307 402 300 113	bei Fzg. ohne Vorrüstung Anschluss vorn	S	CAN	C	E	D	L1	H	45
Ford Focus Turnier HP auch für ST-Line nicht für Active nicht für Vignale	09/18-			307 652 600 001		60	21.7	9.5	90	1800		307 489 300 113	09/18- für Fzg. mit Vorrüstung, inkl. WLC 2.0	S	FRE	C	E2	D	L1	H	60
				307 653 600 001		60	24.7	9.5	90	1800		307 490 300 113	09/18- für Fzg. ohne Vorrüstung, inkl. WLC 2.0	S	CAN	C	E	D	L1	V	75

Ford Focus Turnier HP für Fzg. ohne Vorrüstung auch für ST-Line nicht für Active nicht für Vignale	09/18-	KIT		307 652 900 113		60	23.4	9.5	90	1800		im KIT enthalten 307 490 300 113	09/18- für Fzg. ohne Vorrüstung, inkl. WLC 2.0	S	CAN	C	E	D	L1	V	75	
		KIT		307 653 900 113		60	26.4	9.5	90	1800		im KIT enthalten 307 490 300 113	09/18- für Fzg. ohne Vorrüstung, inkl. WLC 2.0	S	CAN	C	E	D	L1	V	75	
Ford Fusion nicht für KFZ mit Einparkhilfe nicht für Calero	04/02-12/12			307 289 600 001		75	15.8	6.3	75	1050		300 072 300 107 300 072 300 113 307 122 300 113		--	FRE	--	--	--	--	V		
													11/05-	S	FRE	--	E	D1	L	V	90	
Ford Fusion nicht für KFZ mit Einparkhilfe nicht für Calero	11/05-12/12	KIT		307 289 900 113		75	17.8	6.3	75	1050		im KIT enthalten 307 122 300 113	11/05-	S	FRE	--	E	D1	L	V	90	
Ford Galaxy inkl. Wärmeschutzblech auch für 4WD Stoßfängerträger nicht erforderlich	05/00-06			321 665 600 001		90	24.0	12.5	100	2500		321 458 300 113		S	FRE	--	E	D1	L1	H	60	
		KIT		321 665 900 113		90	26.0	12.5	100	2500		im KIT enthalten 321 458 300 113		S	FRE	--	E	D1	L1	H	60	
Ford Galaxy 7-Sitzer ohne Niveauregulierung	05/06-09/15			307 306 600 001		90	17.0	12.1	90	2000		307 400 300 113		S		C	E	D	L1		45	
				307 355 600 001		90	19.5	12.1	90	2000												
		KIT		307 306 900 113		90	19.0	11.1	90	2000		im KIT enthalten 307 400 300 113		S		C	E	D	L1		45	
		KIT		307 355 900 113		90	21.5	11.1	90	2000		im KIT enthalten 307 400 300 113		S		C	E	D	L1		45	
Ford Galaxy III 7-Sitzer CK ohne Niveauregulierung nicht für Kfz. mit sensorgesteuerter Heckklappe (Fußsensor) auch für Plugin-Hybrid	09/15-04/23			307 496 600 001		90	20.0	12.1	90	2000		307 499 300 113		S	A	C1	E2	D1	L1	H	60	
		KIT		307 496 900 113		90	24.0	12.1	90	2000		im KIT enthalten 307 499 300 113		S	A	C1	E2	D1	L1	H	60	

























Ford

























Ford Galaxy III 7-Sitzer CK ohne Niveauregulierung nicht für Kfz. mit sensorgesteuerter Heckklappe (Fußsensor) Abdeckklappe für Stoßfängerausschnitt bitte beim Ford-Händler beziehen. auch für Plugin-Hybrid	09/15-04/23			307 497 600 001		90	20.0	12.1	90	2000		307 499 300 113			S	A	C1	E2	D1	L1	H	60
		KIT		307 497 900 113		90	27.0	12.1	90	2000		im KIT enthalten 307 499 300 113			S	A	C1	E2	D1	L1	H	60
Ford Galaxy III 7-Sitzer CK mit Niveauregulierung Abdeckklappe für Stoßfängerausschnitt bitte beim Ford-Händler beziehen. nicht für Kfz. mit sensorgesteuerter Heckklappe (Fußsensor). auch für Plugin-Hybrid	09/15-04/23			307 498 600 001		90	20.0	12.1	90	2000		307 499 300 113			S	A	C1	E2	D1	L1	H	60
Ford Grand C-Max für Fzg. ohne Vorrüstung auch für Titanium	09/10-06/19	KIT		307 402 900 113		60	21.0	10.0	90	1800		im KIT enthalten 307 402 300 113	bei Fzg. ohne Vorrüstung Anschluss vorn	S	CAN	C	E	D	L1	H	45	
		KIT		307 441 900 113		60	23.0	10.0	90	1800		im KIT enthalten 307 402 300 113	bei Fzg. ohne Vorrüstung Anschluss vorn	S	CAN	C	E	D	L1	H	45	
Ford Grand C-Max auch für Titanium	09/10-06/19			307 508 600 001		60	19.2	10.0	90	1800		307 402 300 107	bei Fzg. ohne Vorrüstung Anschluss vorn	S	CAN	C	E	--	--	H	45	
				307 507 600 001		60	25.0	10.0	90	1800		307 402 300 113	bei Fzg. ohne Vorrüstung Anschluss vorn	S	CAN	C	E	D	L1	H	45	
												307 539 300 113	06/15- für Fzg. mit Vorrüstung	S	FRE	C	E2	D	L1	H	90	
Ford Grand C-Max auch für Titanium für Fzg. mit Vorrüstung	06/15-06/19	KIT		307 508 900 113		60	23.0	10.0	90	1800		im KIT enthalten 307 539 300 113	06/15- für Fzg. mit Vorrüstung	S	FRE	C	E2	D	L1	H	90	
		KIT		307 507 900 113		60	29.0	10.0	90	1800		im KIT enthalten 307 539 300 113	06/15- für Fzg. mit Vorrüstung	S	FRE	C	E2	D	L1	H	90	

Ford KA+	06/16-01/20			307 658 600 001		75	19.6	6.1	65	1000		307 576 300 113	-01/20 2.0	inkl. WLC	S	A	C1	E	D1	--	V	90
				307 659 600 001		75	22.4	6.1	65	1000												
		KIT		307 658 900 113		75	20.7	6.1	65	1000	im KIT enthalten 307 576 300 113	-01/20 2.0	inkl. WLC	S	A	C1	E	D1	--	V	90	
		KIT		307 659 900 113		90	23.6	6.1	65	1000	im KIT enthalten 307 576 300 113	-01/20 2.0	inkl. WLC	S	A	C1	E	D1	--	V	90	
Ford Kuga	05/08-04/13			307 564 600 001		120	26.0	10.6	105	2100		307 280 300 113			S	FRE	--	E	D1	L1	H	90
				307 565 600 001		120	26.0	10.6	105	2100												
		KIT		307 564 900 113		120	28.0	10.6	100	2100	im KIT enthalten 307 280 300 113			S	FRE	--	E	D1	L1	H	90	
		KIT		307 565 900 113		120	27.0	10.6	105	2100	im KIT enthalten 307 280 300 113			S	FRE	--	E	D1	L1	H	90	
Ford Kuga	04/13-06/19			307 566 600 001		120	23.0	11.0	100	2100		307 473 300 113			S	CAN	C	E	D	L1	H	60
				307 567 600 001		120	25.0	11.0	100	2100												
		KIT		307 566 900 113		120	25.0	11.0	100	2100	im KIT enthalten 307 473 300 113			S	CAN	C	E	D	L1	H	60	
		KIT		307 567 900 113		120	27.0	11.0	100	2100	im KIT enthalten 307 473 300 113			S	CAN	C	E	D	L1	H	60	
Ford Kuga III auch für Plugin Hybrid auch für AdBlue	07/19-			307 643 600 001		75	21.9	10.8	100	2100		307 489 300 113		für Fzg. mit Vorrüstung, inkl. WLC 2.0, auch für Plugin Hybrid	S	FRE	C	E2	D	L1	H	60
				307 644 600 001		75	24.8	10.8	100	2100												

Ford



















Ford

Ford Kuga III für Fzg. ohne Vorrüstung auch für Plugin Hybrid auch für AdBlue	07/19-	KIT		307 643 900 113		75	23.9	10.8	100	2100	im KIT enthalten 307 490 300 113	für Fzg. ohne Vorrüstung, inkl. WLC 2.0, auch für Plugin Hybrid	S	CAN	C	E	D	L1	V	75
		KIT		307 644 900 113		75	26.8	10.8	100	2100	im KIT enthalten 307 490 300 113	für Fzg. ohne Vorrüstung, inkl. WLC 2.0, auch für Plugin Hybrid	S	CAN	C	E	D	L1	V	75
Ford Kuga III für Fzg. mit Vorrüstung auch für Plugin Hybrid auch für AdBlue	07/19-	KIT		307 489 900 113		75	23.4	10.8	100	2100	im KIT enthalten 307 489 300 113	für Fzg. mit Vorrüstung, inkl. WLC 2.0, auch für Plugin Hybrid	S	FRE	C	E2	D	L1	H	60
		KIT		307 490 900 113		75	26.3	10.8	100	2100	im KIT enthalten 307 489 300 113	für Fzg. mit Vorrüstung, inkl. WLC 2.0, auch für Plugin Hybrid	S	FRE	C	E2	D	L1	H	60
Ford Kuga III nicht für Fzg. mit sensorgesteuerter Heckklappe (Fußsensor)	07/19-	KIT		307 672 900 113		100	32.0	10.8	100	2100	im KIT enthalten 307 001 300 153	07/19- nicht einzeln lieferbar für Fzg. mit Vorrüstung Anschluss hintern, für Fzg. ohne Vorrüstung Anschluss vorn	S	A	C	E	D	L1		60
Ford Mondeo Turnier auch Fzg. mit Niveauregulierung nicht für ST220	11/00-06/07			307 431 600 001		120	19.0	11.0	85	2000										
Ford Mondeo Turnier nicht für Kfz mit Niveauregulierung	06/07-12/14			307 403 600 001		150	17.5	11.6	90	2120	307 400 300 113		S		C	E	D	L1		45
				307 455 600 001		150	19.5	11.6	90	2120										
		KIT		307 403 900 113		150	19.5	11.6	90	2120	im KIT enthalten 307 400 300 113		S		C	E	D	L1		45
		KIT		307 455 900 113		150	21.5	11.6	90	2120	im KIT enthalten 307 400 300 113		S		C	E	D	L1		45
Ford Mondeo V Limousine 4-/5-Türer nicht für Kfz. mit Niveauregulierung, nicht für Modell Vignale	01/15-04/22			307 475 600 001		90	22.5	11.9	100	2500	307 478 300 113		S	A	C1	E2	D1	L1	H	90
		KIT		307 475 900 113		90	24.5	11.9	100	2500	im KIT enthalten 307 478 300 113		S	A	C1	E2	D1	L1	H	90

Ford Mondeo V Limousine 4-/5-Türer auch für Kfz. mit Niveauregulierung, nicht für Modell Vignale	01/15-04/22			307 476 600 001		90	25.0	11.9	100	2500		307 478 300 113			S	A	C1	E2	D1	L1	H	90
		KIT		307 476 900 113		90	27.0	11.9	100	2500		im KIT enthalten 307 478 300 113			S	A	C1	E2	D1	L1	H	90
Ford Mondeo V Turnier nicht für Kfz. mit Niveauregulierung, nicht für Modell Vignale	01/15-04/22			307 475 600 001		90	22.5	11.9	100	2500		307 478 300 113			S	A	C1	E2	D1	L1	H	90
		KIT		307 475 900 113		90	24.5	11.9	100	2500		im KIT enthalten 307 478 300 113			S	A	C1	E2	D1	L1	H	90
Ford Mondeo V Turnier auch für Kfz. mit Niveauregulierung, nicht für Modell Vignale	01/15-04/22			307 476 600 001		90	25.0	11.9	100	2500		307 478 300 113			S	A	C1	E2	D1	L1	H	90
		KIT		307 476 900 113		90	27.0	11.9	100	2500		im KIT enthalten 307 478 300 113			S	A	C1	E2	D1	L1	H	90
Ford Mustang Mach-E CGW	07/21-			307 673 600 001		60	16.7	5.7	30	750		307 490 300 113	07/21- für Fzg. ohne Vorrüstung		S	CAN	C	E	D	L1	V	75
		KIT		307 673 900 113		60	18.7	5.7	30	750		im KIT enthalten 307 490 300 113	07/21- für Fzg. ohne Vorrüstung		S	CAN	C	E	D	L1	V	75
Ford Puma	09/19-			307 640 600 001		70	19.5	7.5	90	1100		307 489 300 113	für Fzg mit Vorrüstung, inkl. WLC 2.0		S	FRE	C	E2	D	L1	H	60
				307 641 600 001		75	22.0	7.5	90	1100		307 490 300 113	für Fzg. ohne Vorrüstung, inkl. WLC 2.0		S	CAN	C	E	D	L1	V	75
Ford Puma für Fzg. ohne Vorrüstung	09/19-	KIT		307 640 900 113		75	21.0	7.5	90	1100		im KIT enthalten 307 490 300 113	für Fzg. ohne Vorrüstung, inkl. WLC 2.0		S	CAN	C	E	D	L1	V	75
		KIT		307 641 900 113		75	23.9	7.5	90	1100		im KIT enthalten 307 490 300 113	für Fzg. ohne Vorrüstung, inkl. WLC 2.0		S	CAN	C	E	D	L1	V	75
Ford Ranger III inkl. Kugelplatte für Kfz. mit integrierter Trittstufe im Stoßfänger	03/12-02/16	KIT		307 613 900 113		30	35.6	16.4	225	3500		im KIT enthalten 343 069 300 113	-02/16		S	CAN	C	E	D	--	V	60

















Ford









Ford

Ford Ranger III inkl. Kugelplatte für Kfz. mit integrierter Trittstufe im Stoßfänger	03/12-11/22		307 613 600 001			30	30.6	16.4	225	3500		307 556 300 113	03/16-11/22	S	CAN	C1	E2	D1	L1	V	90
												343 069 300 113									
Ford Ranger III inkl. Kugelplatte für Kfz. mit integrierter Trittstufe im Stoßfänger	03/16-11/22	KIT 	307 556 900 113			30	35.6	16.4	225	3500		im KIT enthalten 307 556 300 113	03/16-11/22	S	CAN	C1	E2	D1	L1	V	90
Ford S-Max ohne Niveauregulierung bei Styling-Paket von Ford- Individual + bei S-Max Titanium S = sichtbarer Ausschnitt	05/06-09/15		307 304 600 001			90	17.7	12.1	90	2000		307 400 300 113		S		C	E	D	L1		45
			307 305 600 001			90	19.5	12.1	90	2000											
		KIT 	307 304 900 113		90	19.7	11.1	90	2000		im KIT enthalten 307 400 300 113	S		C	E	D	L1		45		
		KIT 	307 305 900 113		90	21.5	11.1	90	2000		im KIT enthalten 307 400 300 113	S		C	E	D	L1		45		
Ford S-Max II CJ ohne Niveauregulierung nicht für Kfz. mit sensorgesteuerter Heckklappe (Fußsensor) auch für Plugin-Hybrid	09/15-04/23		307 496 600 001			90	20.0	12.1	90	2000		307 499 300 113	-04/23	S	A	C1	E2	D1	L1	H	60
			KIT 			307 496 900 113		90	24.0	12.1	90	2000									
Ford S-Max II CJ ohne Niveauregulierung Abdeckklappe für Stoßfängerausschnitt bitte beim Ford-Händler beziehen. nicht für Kfz. mit sensorgesteuerter Heckklappe (Fußsensor) auch für Plugin-Hybrid	09/15-04/23		307 497 600 001			90	20.0	12.1	90	2000		307 499 300 113	-04/23	S	A	C1	E2	D1	L1	H	60
			KIT 			307 497 900 113		90	27.0	12.1	90	2000									
Ford S-Max II CJ mit Niveauregulierung Abdeckklappe für Stoßfängerausschnitt bitte beim Ford-Händler beziehen. nicht für Kfz. mit sensorgesteuerter Heckklappe (Fußsensor) auch für Plugin-Hybrid	09/15-04/23		307 498 600 001			90	20.0	12.1	90	2000		307 499 300 113	-04/23	S	A	C1	E2	D1	L1	H	60





























Ford Tourneo Connect II für Fzg. mit Vorrüstung nicht für Active	02/14-08/18	KIT		307 500 900 113		90	16.6	8.3	75	1250		im KIT enthalten 307 500 300 113	-08/18 für Fzg. mit Vorrüstung	S	CAN		E	D	L1	H	60
		KIT		307 501 900 113		90	16.6	8.3	75	1250		im KIT enthalten 307 500 300 113	-08/18 für Fzg. mit Vorrüstung	S	CAN		E	D	L1	H	60
Ford Tourneo Connect II nicht für Active	02/14-01/22			307 500 600 001		90	15.5	8.3	75	1250		307 500 300 113	-08/18 für Fzg. mit Vorrüstung	S	CAN		E	D	L1	H	60
				307 501 600 001		90	15.5	8.3	75	1250		307 576 300 113	09/18- inkl. WLC 2.0	S	A	C1	E	D1	--	V	90
Ford Tourneo Connect II nicht für Active	09/18-01/22	KIT		307 576 900 113		90	16.6	8.3	75	1250		im KIT enthalten 307 576 300 113	09/18- inkl. WLC 2.0	S	A	C1	E	D1	--	V	90
		KIT		307 577 900 113		90	16.6	8.3	75	1250		im KIT enthalten 307 576 300 113	09/18- inkl. WLC 2.0	S	A	C1	E	D1	--	V	90
Ford Tourneo Connect III	02/22-			322 088 600 001		90	20.0	9.8	119	1620		322 088 300 113	02/22- für Fzg. mit Vorrüstung	S	CAN	C	E	D	L	H	30
				322 089 600 001		90	23.0	9.8	119	1620		322 089 300 113	02/22- für Fzg. ohne Vorrüstung	S	CAN	C	E	D	L	V	60
												322 092 300 113	02/22- für Fzg. ohne Vorrüstung, inkl. WLC 2.0	S	CAN	C	E	D	L	V	90
Ford Tourneo Connect III für Fzg. ohne Vorrüstung	02/22-	KIT		322 088 900 113		90	22.0	9.8	119	1620		im KIT enthalten 322 092 300 113	02/22- für Fzg. ohne Vorrüstung, inkl. WLC 2.0	S	CAN	C	E	D	L	V	90
		KIT		322 089 900 113			90	25.0	9.8	119		1620	im KIT enthalten 322 092 300 113	02/22- für Fzg. ohne Vorrüstung, inkl. WLC 2.0	S	CAN	C	E	D	L	V
Ford Tourneo Connect III für Fzg. mit Vorrüstung	02/22-	KIT		322 086 900 113		90	21.5	9.8	119	1620		im KIT enthalten 322 088 300 113	02/22- für Fzg. mit Vorrüstung	S	CAN	C	E	D	L	H	30
		KIT		322 087 900 113		90	24.5	9.8	119	1620		im KIT enthalten 322 088 300 113	02/22- für Fzg. mit Vorrüstung	S	CAN	C	E	D	L	H	30

Ford

Ford Tourneo Courier nicht für AdBlue	02/14-10/23			307 638 600 001			45	18.9	5.9	50	910		307 573 300 113	-10/23	S	A	C1	E1	D1	--	H	75
				307 639 600 001			45	20.3	5.9	50	910											
	KIT			307 638 900 113			45	20.6	5.9	50	910		im KIT enthalten 307 573 300 113	-10/23	S	A	C1	E1	D1	--	H	75
		KIT			307 639 900 113			45	22.0	5.9	50	910		im KIT enthalten 307 573 300 113	-10/23	S	A	C1	E1	D1	--	H
Ford Tourneo Custom Kasten/ Kombi V362	11/12-			307 382 600 001			30	17.2	14.9	120	2800		307 386 300 113	-05/16	S	CAN	C	E	D	L1	V	90
					307 624 300 113									06/16-	S	C2	C1	E2	D	L1	V	60
Ford Tourneo Custom Kasten/ Kombi	11/12-			307 385 600 001			30	23.0	14.9	120	2800		307 386 300 113	-05/16	S	CAN	C	E	D	L1	V	90
Ford Tourneo Custom Kasten/ Kombi V362 inkl. Kugelplatte	11/12-05/16	KIT		307 382 900 113			30	19.0	14.9	120	2800		im KIT enthalten 307 386 300 113	-05/16	S	CAN	C	E	D	L1	V	90
Ford Tourneo Custom Kasten/ Kombi V362	11/12-05/16	KIT		307 385 900 113			30	25.0	14.9	120	2800		im KIT enthalten 307 386 300 113	-05/16	S	CAN	C	E	D	L1	V	90
Ford Transit Connect II für Fzg. mit Vorrüstung nicht für Active	02/14-08/18	KIT		307 500 900 113			90	16.6	8.3	75	1250		im KIT enthalten 307 500 300 113	-08/18 für Fzg. mit Vorrüstung	S	CAN		E	D	L1	H	60
		KIT		307 501 900 113			90	16.6	8.3	75	1250		im KIT enthalten 307 500 300 113	-08/18 für Fzg. mit Vorrüstung	S	CAN		E	D	L1	H	60
Ford Transit Connect II nicht für Active	02/14-01/22			307 500 600 001			90	15.5	8.3	75	1250		307 500 300 113	-08/18 für Fzg. mit Vorrüstung	S	CAN		E	D	L1	H	60
				307 501 600 001			90	15.5	8.3	75	1250		307 576 300 113	09/18- inkl. WLC 2.0	S	A	C1	E	D1	--	V	90
Ford Transit Connect II nicht für Active	09/18-01/22	KIT		307 576 900 113			90	16.6	8.3	75	1250		im KIT enthalten 307 576 300 113	09/18- inkl. WLC 2.0	S	A	C1	E	D1	--	V	90
		KIT		307 577 900 113			90	16.6	8.3	75	1250		im KIT enthalten 307 576 300 113	09/18- inkl. WLC 2.0	S	A	C1	E	D1	--	V	90





Ford Transit Courier B460 nicht für AdBlue	02/14-10/23			307 638 600 001			45	18.9	5.9	50	910		307 573 300 113	-10/23	S	A	C1	E1	D1	--	H	75
				307 639 600 001			45	20.3	5.9	50	910											
		KIT		307 638 900 113			45	20.6	5.9	50	910		im KIT enthalten 307 573 300 113	-10/23	S	A	C1	E1	D1	--	H	75
		KIT		307 639 900 113			45	22.0	5.9	50	910		im KIT enthalten 307 573 300 113	-10/23	S	A	C1	E1	D1	--	H	75
Ford Transit Custom Kasten/ Kombi V362	11/12-			307 382 600 001			30	17.2	14.9	120	2800		307 386 300 113	-04/16	S	CAN	C	E	D	L1	V	90
													307 575 300 113	05/16-06/19	S	A	C1	E2	D	L1	V	75
														307 624 300 113	06/16-	S	C2	C1	E2	D	L1	V
Ford Transit Custom Kasten/ Kombi	11/12-			307 385 600 001			30	23.0	14.9	120	2800		307 386 300 113	-04/16	S	CAN	C	E	D	L1	V	90
													307 575 300 113	05/16-06/19	S	A	C1	E2	D	L1	V	75
														307 624 300 113	06/16-	S	C2	C1	E2	D	L1	V
Ford Transit Custom Kasten/ Kombi inkl. Kugelplatte	11/12-04/16	KIT		307 382 900 113			30	19.0	14.9	120	2800		im KIT enthalten 307 386 300 113	-04/16	S	CAN	C	E	D	L1	V	90
Ford Transit Custom Kasten/ Kombi	11/12-04/16	KIT		307 385 900 113			30	25.0	14.9	120	2800		im KIT enthalten 307 386 300 113	-04/16	S	CAN	C	E	D	L1	V	90
Ford Transit Kasten/Kombi Typbezeichnung beginnt mit "F" inkl. Kugelkopf nicht für Kfz mit Trittstufe Trittstufe: 313440600001 Für Kfz. ab Bj. Aug. 2004 bitte, falls nicht serienmäßig verbaut, folgende Teile bei Ford zusätzlich bestellen: Längsträgerverstärkung 1 x FINIS 4583024, Käfigmutter 2 x FINIS 4105891, Schraube 2 x FINIS 4046120	04/00-12/12	KIT		307 260 900 113			60	18.2	15.3	112	2800		im KIT enthalten 307 260 300 113		S	FRE	--	--	D1	--	V	75



























Ford

Honda Accord Limousine (CU) nicht für Typ S	01/08-12/15		338 066 600 001		90	21.0	9.5	75	1700	300 072 300 107	--	FRE	--	--	--	--	V		
											300 072 300 113	--	FRE	--	--	D1	L1	V	
Honda Accord Tourer (CW)	01/08-12/15		338 066 600 001		90	21.0	9.5	75	1700	300 072 300 107	--	FRE	--	--	--	--	V		
											300 072 300 113	--	FRE	--	--	D1	L1	V	
Honda CRV IV (RM) nicht für AdBlue	11/12-09/18		338 107 600 001		90	19.0	10.7	100	2000	300 210 300 113	--	A	--	E1	D1	L1	V	90	
			338 108 600 001			90	20.0	10.7	100		2000								
Honda CRV V (RW) auch für Hybrid nicht für Kfz. mit sensorgesteuerter Heckklappe (Fußsensor)	10/18-08/23		338 130 600 001		60	25.5	10.6	120	2000										
			338 131 600 001			60	28.2	10.6	120	2000									
Honda Civic IX Tourer	02/14-02/18		338 120 600 001		75	26.0	8.2	75	1400	300 210 300 113	--	A	--	E1	D1	L1	V	90	
Honda Civic VIII 3-/5-Türer nicht für Civic "R"	01/06-09/11		338 091 600 001		60	22.0	8.3	75	1500	300 072 300 107	--	FRE	--	--	--	--	V		
											300 072 300 113	--	FRE	--	--	D1	L1	V	
Honda Civic X Schrägheck nicht für Typ R nicht für Sport Plus	02/17-07/22		338 127 600 001		60	21.7	8.5	103	1550										
			338 128 600 001			60	24.7	8.5	103	1550									
Honda HRV II	09/15-09/21		338 109 600 001		120	21.2	8.1	60	1400	338 110 300 113	S	A		E2	D	L1	V	90	
			338 110 600 001			120	22.3	8.1	60		1400								
		KIT		338 109 900 113		120	25.0	8.1	60	1400	im KIT enthalten 338 110 300 113	S	A		E2	D	L1	V	90
		KIT		338 110 900 113		120	27.0	8.1	60	1400	im KIT enthalten 338 110 300 113	S	A		E2	D	L1	V	90

Honda





























Honda

Honda Jazz IV GK	09/15-01/20		338 125 600 001		60	20.0	6.2	76	1000	300 210 300 113					--	A	--	E1	D1	L1	V	90
			338 126 600 001		60	22.0	6.2	76	1000													

Hyundai I 10 ist vom Hersteller nicht für den Anhängerbetrieb freigegeben.	11/13-																																		
Hyundai I 20 3-/5-Türer	01/09-12/14			346 084 600 001		90	20.0	6.6	50	1200		300 210 300 113				--	A	--	E1	D1	L1	V	90												
Hyundai I 20 5-Türer nicht für I 20 Coupé	01/15-08/20			346 105 600 001		60	20.0	6.8	50	1100		300 210 300 113				--	A	--	E1	D1	L1	V	90												
				346 106 600 001		60	23.0	6.8	50	1100																									
Hyundai I 20 Active	01/16-08/20			346 105 600 001		60	20.0	6.8	50	1100		300 210 300 113				--	A	--	E1	D1	L1	V	90												
				346 106 600 001		60	23.0	6.8	50	1100																									
Hyundai I 20 III BC3 nicht für I 20 N	08/20-			346 173 600 001		60	20.0	7.3	89	1300																									
				346 172 600 001		60	17.8	7.3	89	1300																									
Hyundai I 30 Fastback PDE nicht für I 30 N Fastback nicht für N-Line	06/17-			346 157 600 001		90	19.9	8.7	101	1500		346 143 300 113					S	A	--	E2	D1	L1	V	90											
				346 158 600 001		90	23.6	8.7	101	1500																									
		KIT		346 157 900 113		90	21.5	8.7	101	1500		im KIT enthalten 346 143 300 113					S	A	--	E2	D1	L1	V	90											
		KIT		346 158 900 113		90	25.2	8.7	101	1500		im KIT enthalten 346 143 300 113					S	A	--	E2	D1	L1	V	90											
Hyundai I 30 Schrägheck auch für I30 Coupe 03/13- nicht für GT, nicht für Turbo	03/12-01/17			345 086 600 001		60	20.0	8.3	75	1500		346 071 300 113					S	A	--	E1	D1	--	V	75											
		KIT		346 071 900 113		60	22.0	8.3	75	1500		im KIT enthalten 346 071 300 113					S	A	--	E1	D1	--	V	75											







Hyundai



Hyundai I 30 Schrägheck nicht für 2.0 N nicht für AdBlue nicht für N-Line	01/17-08/18		346 124 600 001		60	21.8	8.3	80	1500		346 143 300 113			S	A	--	E2	D1	L1	V	90	
		KIT		346 112 900 113		60	28.0	8.3	80	1500		im KIT enthalten 346 143 300 113			S	A	--	E2	D1	L1	V	90
Hyundai I 30 Schrägheck nicht für 2.0 N nicht für AdBlue nicht für Kfz. mit Einparkhilfe nicht für N-Line	01/17-08/18		346 123 600 001		60	21.8	8.3	80	1500		346 143 300 113			S	A	--	E2	D1	L1	V	90	
		KIT		346 111 900 113		60	26.8	8.3	80	1500		im KIT enthalten 346 143 300 113			S	A	--	E2	D1	L1	V	90
Hyundai I 30 Schrägheck auch für AdBlue auch für N-Line -06/20	09/18-		346 155 600 001		75	19.8	8.7	106	1620		346 143 300 113			S	A	--	E2	D1	L1	V	90	
			346 156 600 001		75	22.5	8.7	106	1620						S	A	--	E2	D1	L1	V	90
		KIT		346 155 900 113		75	21.4	8.7	106	1620		im KIT enthalten 346 143 300 113			S	A	--	E2	D1	L1	V	90
		KIT		346 156 900 113		75	24.1	8.7	106	1620		im KIT enthalten 346 143 300 113			S	A	--	E2	D1	L1	V	90
Hyundai I 30 Stationwagen nicht für 2.0 N nicht für AdBlue	07/17-07/20		346 124 600 001		60	21.8	8.3	80	1500		346 145 300 113			S	A	C1	E2	D1	L1	V	90	
		KIT		346 124 900 113		60	23.8	8.3	80	1500		im KIT enthalten 346 145 300 113			S	A	C1	E2	D1	L1	V	90
Hyundai I 30 Stationwagen nicht für Kfz. mit Einparkhilfe nicht für 2.0 N nicht für AdBlue	07/17-07/20		346 123 600 001		60	21.8	8.3	80	1500		346 145 300 113			S	A	C1	E2	D1	L1	V	90	
		KIT		346 123 900 113		60	22.6	8.3	80	1500		im KIT enthalten 346 145 300 113			S	A	C1	E2	D1	L1	V	90

Hyundai I 30 cw Kombi	06/12-06/17			345 111 600 001		60	19.0	8.5	75	1500	346 071 300 113			S	A	--	E1	D1	--	V	75
				345 112 600 001		60	24.5	8.5	75	1500											
		KIT		346 073 900 113		90	22.0	8.5	75	1500	im KIT enthalten 346 071 300 113			S	A	--	E1	D1	--	V	75
		KIT		346 074 900 113		90	25.0	8.5	75	1500	im KIT enthalten 346 071 300 113			S	A	--	E1	D1	--	V	75
Hyundai IX 20	11/10-07/19			346 063 600 001		90	20.0	7.6	75	1300	346 064 300 113			S	A	--	E1	D1	--	V	75
				346 064 600 001		90	21.0	7.6	75	1300											
		KIT		346 063 900 113		90	22.0	7.6	75	1300	im KIT enthalten 346 064 300 113			S	A	--	E1	D1	--	V	75
		KIT		346 064 900 113		90	23.0	7.6	75	1300	im KIT enthalten 346 064 300 113			S	A	--	E1	D1	--	V	75
Hyundai IX 35	03/10-09/15			346 048 600 001		90	23.0	11.1	96	2400	346 049 300 113			S	A	--	E2	D1	L1	V	90
				346 049 600 001		90	28.7	11.1	96	2400											
		KIT		346 048 900 113		90	25.0	11.1	96	2400	im KIT enthalten 346 049 300 113			S	A	--	E2	D1	L1	V	90
		KIT		346 049 900 113		90	30.5	11.1	96	2400	im KIT enthalten 346 049 300 113			S	A	--	E2	D1	L1	V	90
Hyundai Ioniq 5 NE	05/21-			346 175 600 001		90	19.0	10.0	122	1650	345 150 300 113		05/21- für Fzg. mit Vorrüstung	S	A	--	E2	D	L	H	75
Hyundai Ioniq 5 NE für Fzg. mit Vorrüstung	05/21-	KIT		346 175 900 113		90		10.0	122	1650	im KIT enthalten 345 150 300 113		05/21- für Fzg. mit Vorrüstung	S	A	--	E2	D	L	H	75



Hyundai













Hyundai

Hyundai Tucson IV NX4E für Fzg. mit Vorrüstung	11/20-	KIT		346 165 900 113		60	21.0	11.5	140	2200	im KIT enthalten 345 150 300 113	11/20- für Fzg. mit Vorrüstung	S	A	--	E2	D	L	H	75
		KIT		346 166 900 113		60	24.0	11.5	140	2200	im KIT enthalten 345 150 300 113	11/20- für Fzg. mit Vorrüstung	S	A	--	E2	D	L	H	75
		KIT		346 171 900 113		90	33.0	11.5	140	2200	im KIT enthalten 346 001 300 153	nicht einzeln lieferbar	S	CAN	--	E2	D	L	H	75





















Isuzu D-Max 4x4 nicht für 4x2 nicht Fzg. Doppelrohr- Auspuffanlage inkl. Kugelplatte	06/12-12/20			342 195 600 001			90	29.0	16.1	140	3500												
Isuzu D-Max III TF nicht für Fzg. mit Unterfahrschutz	01/21-			342 304 600 001			60	29.7	16.4	245	3500		342 315 300 113		01/21-	S	FRE	--	E	D	L	H	15
		KIT		342 304 900 113	→		60	30.9	16.4	245	3500		im KIT enthalten 342 315 300 113		01/21-	S	FRE	--	E	D	L	H	15













Iveco-Magirus





























Iveco-Daily VI Kasten / Kombi 33 - 50 inkl. Kugelplatte für Fzg. mit Anhängerkupplungs- Vorbereitung nur für Fzg. mit einlagigem Rahmen	03/14-			342 284 600 001			45	35.1	21.1	140	3500		342 239 300 113	für Fzg. mit Vorrüstung	S	FRE	--	--	D	L	H	45
Iveco-Daily VI Pritsche 33 - 50 inkl. Kugelplatte für Fzg. mit Anhängerkupplungs- Vorbereitung nur für Fzg. mit einlagigem Rahmen	03/14-			342 284 600 001			45	35.1	21.1	140	3500		342 239 300 113	für Fzg. mit Vorrüstung	S	FRE	--	--	D	L	H	45

Jaguar E-Pace nicht für P160 Frontantrieb	09/17-			323 178 600 001		60	26.1	10.1	100	1800		323 189 300 113	09/17-12/20	S	C2	C1	E2	D	L	H	45
				323 179 600 001			60	28.5	10.1	100											
Jaguar F-Pace X761 nicht für SVR	01/16-			323 146 600 001		90	31.1	12.2	100	2400		323 146 300 113	06/17-12/18	S	CAN	--	--	D	L	H	60
				323 189 300 113			90	32.1	12.2	100		2400	323 189 300 113	01/19-12/20	S	C2	C1	E2	D	L	H
Jaguar F-Pace X761 nicht für SVR	06/17-12/18	KIT		323 146 900 113		90	32.1	12.2	100	2400		im KIT enthalten 323 146 300 113	06/17-12/18	S	CAN	--	--	D	L	H	60
Jaguar XE nicht für XE S inkl. XE (X760) 2019-	03/15-			323 149 600 001		90	24.2	10.6	100	2000											
Jaguar XF X260 nicht für Sportbrake	05/15-			323 150 600 001		90	24.1	10.6	100	2000											

























Jeep

























Jeep Avenger Bitte prüfen, ob Anhängelast in den Fahrzeugpapieren eingetragen ist.	03/23-		304 216 600 001		90	25.0	7.1	61	1200												
Jeep Cherokee	03/08-03/14		342 131 600 001		90	30.0	15.3	140	3500		300 210 300 113			--	A	--	E1	D1	L1	V	90
Jeep Cherokee Onroad / KL	04/14-09/18		342 207 600 001		60	33.0	12.4	150	2500		306 528 300 113	10/18-	S	A	C1	E2	D	L1	V	150	
											342 200 300 113	→ -09/18	S	A		E2	D	L1	V	150	
Jeep Compass (MP) auch für AdBlue auch für Hybrid (4xe) nicht für Trailhawk nicht für Kfz. mit sensorgesteuerter Heckklappe (Fußsensor)	12/16-		342 301 600 001		60	23.3	10.2	95	1900		342 265 300 113		S	CAN	--	E	D	L1	V	75	
			342 302 600 001		60	26.3	10.2	95	1900												
		KIT		342 301 900 113		60	26.5	10.2	95	1900	im KIT enthalten 342 265 300 113		S	CAN	--	E	D	L1	V	75	
		KIT		342 302 900 113		60	28.4	10.2	95	1900	im KIT enthalten 342 265 300 113		S	CAN	--	E	D	L1	V	75	
Jeep Grand Cherokee nicht für SRT8 auch für Summit nicht für Trackhawk	04/11-06/13	KIT		342 185 900 113		90	23.0	16.0	175	3500	im KIT enthalten 342 184 300 113	-06/13	S	A	C	--	D	L1	V	120	
Jeep Grand Cherokee WK2 auch für Facelift 06/13- nicht für SRT8/Summit/Trackhawk	04/11-04/21		342 184 600 001		90	21.0	16.0	175	3500		342 184 300 113	-06/13	S	A	C	--	D	L1	V	120	
											342 190 300 113	06/13-	S	A	--	E1	D	L1	V	120	
Jeep Grand Cherokee WK2 nicht für SRT8 auch für Summit nicht für Trackhawk	04/11-04/21		342 221 600 001		90	23.0	16.0	175	3500		342 184 300 113	-06/13	S	A	C	--	D	L1	V	120	
											342 190 300 113	06/13-	S	A	--	E1	D	L1	V	120	
Jeep Grand Cherokee WK2 nicht für SRT8 auch für Summit nicht für Trackhawk	06/13-04/21	KIT		342 190 900 113		90	23.0	16.0	175	3500	im KIT enthalten 342 190 300 113	06/13-	S	A	--	E1	D	L1	V	120	

Jeep Renegade auch für AdBlue auch für Hybrid (4xe) auch für Cross nicht für Sport nicht für Trailhawk	07/14-			342 301 600 001		60	23.3	10.2	95	1900		342 300 300 113	07/14-	--	FRE	--	E	D1	L1	V	150
				342 302 600 001		60	26.3	10.2	95	1900											
	KIT			342 299 900 113		60	25.2	10.2	95	1900		im KIT enthalten 342 300 300 113	07/14-	--	FRE	--	E	D1	L1	V	150
	KIT			342 300 900 113		60	28.2	10.2	95	1900		im KIT enthalten 342 300 300 113	07/14-	--	FRE	--	E	D1	L1	V	150
Jeep Wrangler III (JK) AdBlue-Modelle -10/17 inkl. Kugelplatte	04/07-10/17			342 104 600 001		60	12.0	15.0	170	3500		342 105 300 113		S	A	--	E2	D	L1	V	150
Jeep Wrangler III (JK) AdBlue-Modelle -10/17	04/07-10/17			306 535 600 001		30	12.0	15.1	140	3500		342 105 300 113		S	A	--	E2	D	L1	V	150
		KIT			306 535 900 113		30	13.6	15.1	140	3500		im KIT enthalten 342 105 300 113		S	A	--	E2	D	L1	V
Jeep Wrangler IV (JL) auch für 4xe Plugin Hybrid	11/17-			306 535 600 001		30	12.0	15.1	140	3500		342 105 300 113		S	A	--	E2	D	L1	V	150
		KIT			306 535 900 113		30	13.6	15.1	140	3500		im KIT enthalten 342 105 300 113		S	A	--	E2	D	L1	V





















Kia Ceed	03/18-			345 146 600 001		45	19.8	8.4	100	1500		345 134 300 113	03/18- inkl. WLC 2.0	S	A	C1	E2	D1	L1	V	60	
				345 147 600 001		45	22.5	8.4	100	1500												
		KIT		345 146 900 113		45	20.2	8.4	100	1500	im KIT enthalten 345 134 300 113											03/18- inkl. WLC 2.0
		KIT		345 147 900 113		45	22.9	8.4	100	1500	im KIT enthalten 345 134 300 113											03/18- inkl. WLC 2.0
Kia Ceed Sportswagon nicht für Kfz. mit Einparkhilfe nicht für GT-Line	04/18-			345 144 600 001		45	20.3	8.4	100	1500		345 134 300 113	04/18- inkl. WLC 2.0	S	A	C1	E2	D1	L1	V	60	
		KIT		345 144 900 113		45	21.8	8.4	100	1500	im KIT enthalten 345 134 300 113											04/18- inkl. WLC 2.0
Kia Ceed Sportswagon nicht für GT-Line	04/18-			345 145 600 001		45	23.0	8.4	100	1500		345 134 300 113	04/18- inkl. WLC 2.0	S	A	C1	E2	D1	L1	V	60	
		KIT		345 145 900 113		45	24.5	8.4	100	1500	im KIT enthalten 345 134 300 113											04/18- inkl. WLC 2.0
Kia EV6 CV	07/21-			345 180 600 001		60	24.2	10.6	129	1800		345 150 300 113	07/21- für Fzg. mit Vorrüstung	S	A	--	E2	D	L	H	75	
				345 181 600 001		60		10.6	129	1800												
		KIT		345 180 900 113		60		10.6	129	1800	im KIT enthalten 345 150 300 113											07/21- für Fzg. mit Vorrüstung
Kia EV6 CV für Fzg. mit Vorrüstung	07/21-	KIT		345 181 900 113		60		10.6	129	1800	im KIT enthalten 345 150 300 113	07/21- für Fzg. mit Vorrüstung	S	A	--	E2	D	L	H	75		
Kia Niro I DE nicht für e-Niro	01/17-08/22			345 116 600 001		90	23.3	7.6	100	1300		345 173 300 113	10/17- für Fzg. mit Vorrüstung	S	A	--	E2	D1	L1	H	75	
				345 117 600 001		90	20.8	7.6	100	1300												

Kia























Kia Niro I DE für Fzg. mit Vorrüstung nicht für e-Niro	10/17-08/22	KIT		345 173 900 113		60	21.8	7.6	100	1300		im KIT enthalten 345 173 300 113	10/17- für Fzg. mit Vorrüstung	S	A	--	E2	D1	L1	H	75	
		KIT		345 174 900 113		60	24.1	7.6	100	1300		im KIT enthalten 345 173 300 113	10/17- für Fzg. mit Vorrüstung	S	A	--	E2	D1	L1	H	75	
Kia Optima Fließheck nicht für Hybrid nicht für AdBlue	01/16-09/19			345 113 600 001		60	19.0	9.7	80	1800												
Kia Optima Sportswagon nicht für Hybrid nicht für AdBlue	10/16-09/19			345 113 600 001		60	19.0	9.7	80	1800		345 168 300 113		S	A	C1	E2	D	L1	H	60	
		KIT		345 168 900 113		60	20.0	9.7	80	1800		im KIT enthalten 345 168 300 113		S	A	C1	E2	D	L1	H	60	
Kia ProCee'd nicht für Pro Cee'd GT	03/13-09/18			345 086 600 001		60	20.0	8.3	75	1500		345 086 300 113	-03/18	S	A	--	E2	D1	L1	V	90	
Kia ProCeed CD	10/18-			345 151 600 001		60	20.9	8.5	104	1500		345 134 300 113	10/18- inkl. WLC 2.0	S	A	C1	E2	D1	L1	V	60	
				345 152 600 001		60	23.9	8.5	104	1500												
		KIT		345 151 900 113		60	22.4	8.5	104	1500		im KIT enthalten 345 134 300 113	10/18- inkl. WLC 2.0	S	A	C1	E2	D1	L1	V	60	
		KIT		345 152 900 113		60	25.4	8.5	104	1500		im KIT enthalten 345 134 300 113	10/18- inkl. WLC 2.0	S	A	C1	E2	D1	L1	V	60	
Kia Rio Schrägheck IV YB auch für Facelift	01/17-			345 127 600 001		75	19.7	6.6	75	1110		345 171 300 113		S	A	--	E1	D1	--	V	90	
		KIT		345 127 900 113		75	20.7	6.6	75	1110		im KIT enthalten 345 171 300 113		S	A	--	E1	D1	--	V	90	
Kia Sorento III auch für AdBlue	01/15-03/20			345 142 600 001		60	27.2	12.6	135	2500		345 143 300 113		S	A	--	E2	D	L1	V	90	
				345 143 600 001		60	29.9	12.6	135	2500												

Kia Sorento IV MQ4 auch für Hybrid	03/20-			345 167 600 001		90	20.0	13.0	159	2550	345 150 300 113	03/20- für Fzg. mit Vorrüstung	S	A	--	E2	D	L	H	75
				345 168 600 001		90	22.0	13.0	159	2550										
Kia Sorento IV MQ4 für Fzg. mit Vorrüstung auch für Hybrid	03/20-	KIT		345 165 900 113		90	21.0	13.0	159	2550	im KIT enthalten 345 150 300 113	03/20- für Fzg. mit Vorrüstung	S	A	--	E2	D	L	H	75
				345 166 900 113		90	23.0	13.0	159	2550	im KIT enthalten 345 150 300 113	03/20- für Fzg. mit Vorrüstung	S	A	--	E2	D	L	H	75
Kia Soul PS nicht für Soul EV nicht für Soul Dream Team Edition	04/14-04/19			345 128 600 001		60	21.0	7.6	80	1300										
				345 129 600 001		60	21.0	7.6	80	1300										
Kia Sportage SL	08/10-02/16			345 087 600 001		90	23.0	11.0	80	2400	345 079 300 113		S	A	--	E2	D1	L1	V	90
				345 079 600 001		60	25.0	10.6	80	2300										
		KIT		345 087 900 113		90	25.0	11.0	80	2400	im KIT enthalten 345 079 300 113		S	A	--	E2	D1	L1	V	90
				345 079 900 113		60	27.0	10.6	80	2300	im KIT enthalten 345 079 300 113		S	A	--	E2	D1	L1	V	90
Kia Sportage	02/16-05/18			346 103 600 001		60	25.0	11.3	100	2200	345 155 300 113	-05/18	S	A	--	E2	D	L1	V	60
				346 104 600 001		60	27.0	11.3	100	2200										
		KIT		345 103 900 113		60	29.0	11.3	100	2200	im KIT enthalten 345 155 300 113	-05/18	S	A	--	E2	D	L1	V	60
				345 104 900 113		60	31.0	11.3	100	2200	im KIT enthalten 345 155 300 113	-05/18	S	A	--	E2	D	L1	V	60

Kia























Kia Sportage IV QLE	06/18-09/21			345 140 600 001			75	26.1	10.9	133	2200		345 174 300 113	inkl. WLC 2.0	S	A	C1	E2	D1	L1	V	60
				345 141 600 001			75	27.6	10.9	133	2200											
Kia Sportage V NQ5	09/21-			345 171 600 001			60	19.7	10.8	132	2000		345 150 300 113	09/21- für Fzg. mit Vorrüstung	S	A	--	E2	D	L	H	75
				345 172 600 001			60	21.5	10.8	132	2000											
Kia Sportage V NQ5 für Fzg. mit Vorrüstung	09/21-	KIT		345 171 900 113			60	21.6	10.8	132	2000	im KIT enthalten 345 150 300 113	09/21- für Fzg. mit Vorrüstung	S	A	--	E2	D	L	H	75	
				345 172 900 113			60	23.4	10.8	132	2000	im KIT enthalten 345 150 300 113										09/21- für Fzg. mit Vorrüstung
Kia Stonic I YB	07/17-			345 138 600 001			90	22.2	6.9	75	1110		345 172 300 113			A	--	E2	D1	L1	V	120
				345 139 600 001			90	21.6	6.9	75	1110											
		KIT		345 139 900 113			90	22.6	6.9	75	1110	im KIT enthalten 345 172 300 113				A	--	E2	D1	L1	V	120
Kia Venga I YN	03/10-09/19			345 069 600 001			90	20.0	7.6	75	1300		346 064 300 113	-09/19	S	A	--	E1	D1	--	V	75
				345 070 600 001			90	21.0	7.6	75	1300											









Kia XCeed (CD) auch für Hybrid	06/19-			345 155 600 001		40	23.5	8.5	104	1540		345 134 300 113	06/19- inkl. WLC 2.0	S	A	C1	E2	D1	L1	V	60
				345 156 600 001		40	27.0	8.5	104	1540											
		KIT		345 155 900 113		40	25.2	8.5	104	1540		im KIT enthalten 345 134 300 113	06/19- inkl. WLC 2.0	S	A	C1	E2	D1	L1	V	60
		KIT		345 156 900 113		40	28.8	8.5	104	1540		im KIT enthalten 345 134 300 113	06/19- inkl. WLC 2.0	S	A	C1	E2	D1	L1	V	60

Land Rover Discovery Bitte Original-Spoiler beim Fahrzeughändler bestellen.	05/17-			323 157 600 001		60	40.4	16.3	195	3500		323 107 300 113			S	C2	C	E2	D	L	H	15
		KIT		323 157 900 113		60	42.5	16.3	195	3500		im KIT enthalten 323 107 300 113			S	C2	C	E2	D	L	H	15
Land Rover Discovery Sport L550 7-Sitzer für Kfz. mit Reserveradmulde	09/14-04/19			323 181 600 001		60	34.0	11.8	135	2200		323 141 300 113			S	C2	C	E	D	L	H	45
Land Rover Discovery Sport L550 7-Sitzer für Kfz. ohne Reserveradmulde	02/15-			323 141 600 001		90	28.0	12.5	150	2500		323 141 300 113			S	C2	C	E	D	L	H	45
		KIT		323 141 900 113		90	32.0	12.5	150	2500		im KIT enthalten 323 141 300 113			S	C2	C	E	D	L	H	45
Land Rover Discovery Sport für Kfz. mit Reserveradmulde	05/19-			323 192 600 001		90	39.3	11.3	145	2000		323 189 300 113	05/19-12/20		S	C2	C1	E2	D	L	H	45
												323 191 300 113	01/21-		S	C2	C1	E2	D	L	H	45
Land Rover Freelander 2 auch für Facelift 2013-	05/07-10/14			323 079 600 001		105	20.0	11.0	150	2000		323 411 300 113	→ 10/12-		S	C2	--	E1	D	L	H	30
Range-Rover Evoque L538	09/11-12/18			323 101 600 001		90	18.0	10.6	150	2000		323 102 300 113			S	C2	--	E	D	L	H	30
				323 102 600 001		90	20.0	10.6	150	2000						S	C2	--	E	D	L	H
		KIT		323 101 900 113		90	20.0	10.6	150	2000		im KIT enthalten 323 102 300 113			S	C2	--	E	D	L	H	30
		KIT		323 102 900 113		90	22.0	10.6	150	2000		im KIT enthalten 323 102 300 113			S	C2	--	E	D	L	H	30







Land Rover



























Land Rover

Range-Rover Evoque Cabrio L538	05/16-12/18			323 101 600 001		90	18.0	10.6	150	2000		323 102 300 113			S	C2	--	E	D	L	H	30
				323 102 600 001		90	20.0	10.6	150	2000												
		KIT		323 101 900 113		90	20.0	10.6	150	2000		im KIT enthalten 323 102 300 113			S	C2	--	E	D	L	H	30
		KIT		323 102 900 113		90	22.0	10.6	150	2000		im KIT enthalten 323 102 300 113			S	C2	--	E	D	L	H	30
Range-Rover Evoque II L551 auch für AdBlue	12/18-			323 189 600 001		60	30.3	11.1	130	2000		323 189 300 113	12/18-12/20	S	C2	C1	E2	D	L	H	45	
				323 190 600 001		60	33.4	11.1	130	2000		323 191 300 113	01/21-	S	C2	C1	E2	D	L	H	45	
Range-Rover IV L405	01/13-10/21			323 107 600 001		120	50.5	16.6	200	3500		323 107 300 113	01/13-10/21	S	C2	C	E2	D	L	H	15	
Range-Rover L322 Aufnahmeadapter incl. abnehmbarer Kugelstange, Ablageschale und Befestigungsmaterial (nur in Verbindung mit 323064600001 oder 323074600001)	02/02-12			323 062 600 001		15	11.5	16.4	150	3500		323 064 300 113	-09/09	S	FRE	--	E	D	L	H	30	
Range-Rover Sport Das Fahrzeug ist serienmäßig für den Anhängerbetrieb vorgerüstet. Aufrüstsatz nur beim Land Rover- Händler erhältlich.	03/05-10/13																					
Range-Rover Sport L 494 nicht für Plugin Hybrid	10/13-05/22			323 121 600 001		120	51.5	16.6	200	3500		323 107 300 113			S	C2	C	E2	D	L	H	15
Range-Rover Velar L560 nicht für V6 und V8	10/17-			323 171 600 001		60	33.5	12.5	175	2500		323 146 300 113	10/17-12/18	S	CAN	--	--	D	L	H	60	
				323 189 300 113								323 189 300 113	01/19-12/20	S	C2	C1	E2	D	L	H	45	
Range-Rover Velar L560 nicht für V6 und V8	10/17-12/18	KIT		323 171 900 113		75	34.0	12.5	175	2500		im KIT enthalten 323 146 300 113	10/17-12/18	S	CAN	--	--	D	L	H	60	















Lexus RX 350 / 450 h nicht für Kfz mit Niveauregulierung	05/09-12/15			335 357 600 001		90	38.0	11.8	85	2100		335 357 300 113			S	FRE	--	--	D	L1	V	105
		KIT		335 357 900 113		90	40.0	11.8	85	2100		im KIT enthalten 335 357 300 113			S	FRE	--	--	D	L1	V	105
Lexus RX 350 / 450 h für Kfz mit Niveauregulierung	05/09-12/15			335 358 600 001		90	38.0	11.9	85	2100		335 357 300 113			S	FRE	--	--	D	L1	V	105
		KIT		335 358 900 113		90	40.0	11.9	85	2100		im KIT enthalten 335 357 300 113			S	FRE	--	--	D	L1	V	105

MAN

























MAN TGE Kasten/Kombi Einfachbereifung Kugelplatte bitte separat bestellen: 329141600001 nicht für Kfz mit integrierter Trittstufe im Stoßfänger nicht für e TGE	02/17-		321 946 600 001			30	26.7	17.5	150	3500		321 112 300 113	für Fzg. mit Vorrüstung	S	CAN	--	E	D	L	V	15	
												321 113 300 107	für Fzg. ohne Vorrüstung	S	CAN	C	E	--	--	V	60	
												321 113 300 113	für Fzg. ohne Vorrüstung	S	CAN	C	E	D	L	V	60	
MAN TGE Kasten/Kombi Zwillingbereifung Kugelplatte bitte separat bestellen: 329141600001 nicht für Kfz mit integrierter Trittstufe im Stoßfänger nicht für e TGE	02/17-		321 947 600 001			30	27.0	21.0	150	3500		321 112 300 113	für Fzg. mit Vorrüstung	S	CAN	--	E	D	L	V	15	
												321 113 300 107	für Fzg. ohne Vorrüstung	S	CAN	C	E	--	--	V	60	
												321 113 300 113	für Fzg. ohne Vorrüstung	S	CAN	C	E	D	L	V	60	
MAN TGE Kasten/Kombi für Fzg. ohne Vorrüstung Zwillingbereifung inkl. Kugelplatte nicht für Kfz mit integrierter Trittstufe im Stoßfänger nicht für e TGE	02/17-	KIT		321 947 900 113			30	30.0	21.0	150	3500		im KIT enthalten 321 113 300 113	für Fzg. ohne Vorrüstung	S	CAN	C	E	D	L	V	60
MAN TGE Kasten/Kombi für Fzg. ohne Vorrüstung Einfachbereifung inkl. Kugelplatte nicht für Kfz mit integrierter Trittstufe im Stoßfänger nicht für e TGE	02/17-	KIT		321 946 900 113			30	28.5	17.5	150	3500		im KIT enthalten 321 113 300 113	für Fzg. ohne Vorrüstung	S	CAN	C	E	D	L	V	60
MAN TGE Kasten/Kombi Einfachbereifung inkl. Kugelplatte nur für Kfz mit integrierter Trittstufe im Stoßfänger nicht für e TGE	02/17-		322 011 600 001			60	29.7	15.8	120	3000		321 112 300 113	für Fzg. mit Vorrüstung	S	CAN	--	E	D	L	V	15	
												321 113 300 107	für Fzg. ohne Vorrüstung	S	CAN	C	E	--	--	V	60	
												321 113 300 113	für Fzg. ohne Vorrüstung	S	CAN	C	E	D	L	V	60	
MAN TGE Pritsche Einfachbereifung Kugelplatte bitte separat bestellen: 329141600001 nicht für e TGE	02/17-		321 948 600 001			30	22.0	21.0	150	3500		321 112 300 113	für Fzg. mit Vorrüstung	S	CAN	--	E	D	L	V	15	
												321 113 300 107	für Fzg. ohne Vorrüstung	S	CAN	C	E	--	--	V	60	
												321 113 300 113	für Fzg. ohne Vorrüstung	S	CAN	C	E	D	L	V	60	
MAN TGE Pritsche für Fzg. ohne Vorrüstung Einfachbereifung inkl. Kugelplatte nicht für e TGE	02/17-	KIT		321 948 900 113			30	26.5	21.0	150	3500		im KIT enthalten 321 113 300 113	für Fzg. ohne Vorrüstung	S	CAN	C	E	D	L	V	60













Mazda 2 nicht für Hybrid	02/15-			343 076 600 001		60	20.0	7.0	50	1200		343 076 300 113			S	FRE	--	E	D1	L1	V	90
		KIT		343 076 900 113		60	24.0	7.0	50	1200		im KIT enthalten 343 076 300 113			S	FRE	--	E	D1	L1	V	90
Mazda 3 Schrägheck nicht für MPS (260 PS) nicht für Sportstoßfänger	10/03-10/13			343 038 600 001		90	21.5	8.7	75	1590		300 072 300 107	-03/09	--	FRE	--	--	--	--	--	V	
												300 072 300 113	-03/09	--	FRE	--	--	D1	L1	V		
													343 066 300 113	03/09-	S	A	--	--	D1	--	V	75
Mazda 3 Schrägheck nicht für MPS (260 PS) nicht für Sportstoßfänger	03/09-10/13	KIT		343 038 900 113		60	23.5	8.7	75	1590		im KIT enthalten 343 066 300 113	03/09-	S	A	--	--	D1	--	V	75	
Mazda 3 Schrägheck	10/13-19			343 073 600 001		90	19.0	9.2	75	1800		343 074 300 113	10/13-19	S	A	--	E2	D1	L1	V	90	
				343 074 600 001		90	21.0	9.2	75	1800												
		KIT		343 073 900 113		90	20.0	9.2	75	1800		im KIT enthalten 343 074 300 113	10/13-19	S	A	--	E2	D1	L1	V	90	
		KIT		343 074 900 113		90	22.0	9.2	75	1800		im KIT enthalten 343 074 300 113	10/13-19	S	A	--	E2	D1	L1	V	90	
Mazda 3 Schrägheck (BP)	11/18-			343 114 600 001		60	28.5	7.7	80	1300		343 114 300 113		S	A	--	E2	D	L1	V	105	
				343 115 600 001		60	31.4	7.7	80	1300												
Mazda 3 Stufenheck nicht für MPS (260 PS) nicht für Sport-Stoßfänger	10/03-03/09			343 038 600 001		90	21.5	8.7	75	1590		300 072 300 113		--	FRE	--	--	D1	L1	V		
Mazda 5	10/10-01/18			343 064 600 001		60	19.0	9.8	75	1700												
				343 063 600 001		60	19.0	9.8	75	1700												

Mazda



















Mazda CX5	04/12-04/17			343 053 600 001		90	22.0	10.8	100	2100		343 056 300 113	-04/17	S	A	--	E2	D	L1	V	90
				343 056 600 001		90	25.0	10.8	100	2100											
	KIT			343 053 900 113		90	24.0	10.8	100	2100		im KIT enthalten 343 056 300 113	-04/17	S	A	--	E2	D	L1	V	90
		KIT		343 056 900 113		90	27.0	10.8	100	2100		im KIT enthalten 343 056 300 113	-04/17	S	A	--	E2	D	L1	V	90
Mazda CX5 KF auch für AdBlue auch für Facelift 2021-	05/17-			343 112 600 001		60	23.6	10.8	132	2000		343 099 300 113	05/17-	S	CAN	--	E	D1	L1	V	90
		KIT		343 112 900 113		60	25.2	10.8	132	2000		im KIT enthalten 343 099 300 113	05/17-	S	CAN	--	E	D1	L1	V	90
Mazda Pickup BT50 inkl. Kugelplatte für Kfz. mit integrierter Trittstufe im Stoßfänger	06/12-02/16	KIT		307 613 900 113		30	35.6	16.4	225	3500		im KIT enthalten 343 069 300 113	-02/16	S	CAN	C	E	D	--	V	60
Mazda Pickup BT50 inkl. Kugelplatte für Kfz. mit integrierter Trittstufe im Stoßfänger	06/12-12/20			307 613 600 001		30	30.6	16.4	225	3500		343 069 300 113	-02/16	S	CAN	C	E	D	--	V	60





















Mercedes-Benz

Mercedes A-Klasse W169	09/04-09/12			313 171 600 001		120	18.0	8.5	80	1500		313 231 300 107	für Fzg. ohne Vorrüstung	S	CAN	C	E	--	--	V	90
				313 231 600 001		120	18.0	8.5	80	1500		313 231 300 113		S	CAN	C	E	D1	L1	V	90
		KIT		313 171 900 113		120	19.0	8.5	80	1500		im KIT enthalten 313 231 300 113		S	CAN	C	E	D1	L1	V	90
		KIT		313 231 900 113		120	19.5	8.5	80	1500		im KIT enthalten 313 231 300 113		S	CAN	C	E	D1	L1	V	90
Mercedes A-Klasse W176 nicht für Fahrzeuge mit AMG-Optik-Paket Achtung: Je nach Motorvariante können Änderungen am Kühlsystem des Fahrzeugs notwendig sein.	09/12-05/18			313 396 600 001		60	23.0	9.2	80	1500		313 398 300 107		S	CAN	C	E	--	--	V	105
				313 398 600 001		60	25.0	9.2	80	1500		313 398 300 113		S	CAN	C	E	D	L	V	105
		KIT		313 396 900 113		60	25.0	9.2	80	1900		im KIT enthalten 313 398 300 113		S	CAN	C	E	D	L	V	105
		KIT		313 398 900 113		60	27.0	9.2	80	1500		im KIT enthalten 313 398 300 113		S	CAN	C	E	D	L	V	105
Mercedes A-Klasse W177 auch für AMG nicht für Fzg. mit Aerodynamikpaket	03/18-			313 639 600 001		60	25.3	10.7	120	2100		313 215 300 113	für Fzg. ohne Vorrüstung	S	CAN	C	E	D	L	V	75
				313 640 600 001		60	26.7	10.7	120	2100											
Mercedes A-Klasse W177 für Fzg. ohne Vorrüstung auch für AMG nicht für Fzg. mit Aerodynamikpaket	03/18-	KIT		313 639 900 113		60	24.9	10.7	120	2100		im KIT enthalten 313 215 300 113	für Fzg. ohne Vorrüstung	S	CAN	C	E	D	L	V	75
		KIT		313 640 900 113		60	28.3	10.7	120	2100		im KIT enthalten 313 215 300 113	für Fzg. ohne Vorrüstung	S	CAN	C	E	D	L	V	75
Mercedes A-Klasse Stufenheck W177 auch für AMG nicht für Fzg. mit Aerodynamikpaket	09/18-			313 639 600 001		60	25.3	10.7	120	2100		313 215 300 113	für Fahrzeuge ohne Vorrüstung	S	CAN	C	E	D	L	V	75
				313 640 600 001		60	26.7	10.7	120	2100											

Mercedes A-Klasse Stufenheck W177 für Fzg. ohne Vorrüstung auch für AMG nicht für Fzg. mit Aerodynamikpaket	09/18-	KIT		313 639 900 113		60	24.9	10.7	120	2100		im KIT enthalten 313 215 300 113	für Fahrzeuge ohne Vorrüstung	S	CAN	C	E	D	L	V	75
		KIT		313 640 900 113		60	28.3	10.7	120	2100		im KIT enthalten 313 215 300 113	für Fahrzeuge ohne Vorrüstung	S	CAN	C	E	D	L	V	75
Mercedes Atego Anhängelock mit integriertem Unterfahrerschutz (Lieferung nur paarig: 313404600002 + 313404600003) Freiräume für die Montage prüfen (Maßblatt siehe "Anhängelöcke"). empfohlene Anschraubplatte: 329103600001 Wechselsystem oder Maulkupplung möglich	01/97-			313 404 600 001		90	69.0	25.1	150	3500		300 201 300 113	für 12V Fahrzeuge	--	A	--	E1	D1	--	V	
Mercedes Atego Anhängelock mit integriertem Unterfahrerschutz (Lieferung nur paarig: 342179600002 + 342179600003) Freiräume für die Montage prüfen (Maßblatt siehe "Anhängelöcke"). empfohlene Anschraubplatte: 329103600001 Wechselsystem oder Maulkupplung möglich	01/97-			342 179 600 001		90	76.0	23.5	150	3500		300 201 300 113	für 12V Fahrzeuge	--	A	--	E1	D1	--	V	
Mercedes B-Klasse W245	06/05-10/11			313 171 600 001		120	18.0	8.5	80	1500		313 231 300 107	für Fzg. ohne Vorrüstung	S	CAN	C	E	--	--	V	90
				313 231 600 001		120	18.0	8.5	80	1500		313 231 300 113		S	CAN	C	E	D1	L1	V	90
		KIT		313 171 900 113		120	19.0	8.5	80	1500		im KIT enthalten 313 231 300 113		S	CAN	C	E	D1	L1	V	90
		KIT		313 231 900 113		120	19.5	8.5	80	1500		im KIT enthalten 313 231 300 113		S	CAN	C	E	D1	L1	V	90











Mercedes-Benz











Mercedes B-Klasse W246 nicht für Fahrzeuge mit AMG-Optik-Paket nicht für Electric Drive B250e Achtung: Je nach Motorvariante können Änderungen am Kühlsystem des Fahrzeugs notwendig sein.	11/11-12/18			313 396 600 001			60	23.0	9.2	80	1500		313 398 300 107			S	CAN	C	E	--	--	V	105
				313 398 600 001			60	25.0	9.2	80	1500		313 398 300 113			S	CAN	C	E	D	L	V	105
		KIT		313 396 900 113			60	25.0	9.2	80	1900		im KIT enthalten 313 398 300 113	S	CAN	C	E	D	L	V	105		
		KIT		313 398 900 113			60	27.0	9.2	80	1500		im KIT enthalten 313 398 300 113	S	CAN	C	E	D	L	V	105		
Mercedes B-Klasse W247	12/18-			313 639 600 001			60	25.3	10.7	120	2100		313 215 300 113		für Fahrzeuge ohne Vorrüstung	S	CAN	C	E	D	L	V	75
				313 640 600 001			60	26.7	10.7	120	2100												
Mercedes B-Klasse W247 für Fzg. ohne Vorrüstung	12/18-	KIT		313 639 900 113			60	24.9	10.7	120	2100		im KIT enthalten 313 215 300 113		für Fahrzeuge ohne Vorrüstung	S	CAN	C	E	D	L	V	75
		KIT		313 640 900 113			60	28.3	10.7	120	2100		im KIT enthalten 313 215 300 113		für Fahrzeuge ohne Vorrüstung	S	CAN	C	E	D	L	V	75
Mercedes C-Klasse Cabrio A205 nicht für AMG C63, AMG C63S auch für AMG-Optik-Paket nicht für Kfz. mit Niveauregulierung	07/16-06/18	KIT		313 431 900 113			120	23.0	10.5	85	1900		im KIT enthalten 313 432 300 113		-06/18	S	CAN	C	E	D	L1	H	45
Mercedes C-Klasse Cabrio A205 nicht für AMG C63, AMG C63S auch für AMG-Optik-Paket auch für Kfz. mit Niveauregulierung	07/16-06/18	KIT		313 432 900 113			120	24.0	10.5	85	1900		im KIT enthalten 313 432 300 113		-06/18	S	CAN	C	E	D	L1	H	45
Mercedes C-Klasse Cabrio A205 nicht für AMG C63, AMG C63S auch für AMG-Optik-Paket nicht für Kfz. mit Niveauregulierung	07/16-03/23			313 431 600 001			120	21.0	10.5	85	1900	313 432 300 107	-06/18	S	CAN	C	E	--	--	H	45		
												313 432 300 113	-06/18	S	CAN	C	E	D	L1	H	45		
												313 445 300 113	07/18-03/23 inkl. WLC 2.0	S	FRE	C	E	D	L1	H	60		

Mercedes C-Klasse Cabrio A205 nicht für AMG C63, AMG C63S auch für AMG-Optik-Paket auch für Kfz. mit Niveauregulierung	07/16-03/23		313 432 600 001		120	23.0	10.5	85	1900	313 432 300 107 313 432 300 113 313 445 300 113	-06/18	S	CAN	C	E	--	--	H	45
					-06/18	S	CAN	C	E		D	L1	H	45					
					07/18-03/23 inkl. WLC 2.0	S	FRE	C	E		D	L1	H	60					
Mercedes C-Klasse Cabrio A205 nicht für AMG C63, AMG C63S auch für AMG-Optik-Paket nicht für Kfz. mit Niveauregulierung	07/18-03/23	KIT 	313 445 900 113		120	29.1	10.5	85	1900	im KIT enthalten 313 445 300 113	07/18-03/23 inkl. WLC 2.0	S	FRE	C	E	D	L1	H	60
Mercedes C-Klasse Cabrio A205 nicht für AMG C63, AMG C63S auch für AMG-Optik-Paket auch für Kfz. mit Niveauregulierung	07/18-03/23	KIT 	313 446 900 113		120	29.1	10.5	85	1900	im KIT enthalten 313 445 300 113	07/18-03/23 inkl. WLC 2.0	S	FRE	C	E	D	L1	H	60
Mercedes C-Klasse Coupé C204 + C204 AMG-Styling	06/11-09/15		313 214 600 001		>150	21.0	10.2	75	1900	313 361 300 107 313 361 300 113		S	CAN	C	E	--	--	H	45
						313 438 600 001		120	23.0		10.2	75	1900	S	CAN	C	E	D	L
		KIT 	313 389 900 113		>150	23.0	10.2	75	1900	im KIT enthalten 313 361 300 113	S	CAN	C	E	D	L	H	45	
		KIT 	313 211 900 113		>150	25.0	10.2	75	1900	im KIT enthalten 313 361 300 113	S	CAN	C	E	D	L	H	45	
		Mercedes C-Klasse Coupé C205 nicht für AMG C63, AMG C63S auch für AMG-Optik-Paket nicht für Kfz. mit Niveauregulierung	10/15-06/18	KIT 	313 431 900 113		120	23.0	10.5	85	1900	im KIT enthalten 313 432 300 113	-06/18	S	CAN	C	E	D	L1
Mercedes C-Klasse Coupé C205 nicht für AMG C63, AMG C63S auch für AMG-Optik-Paket auch für Kfz. mit Niveauregulierung	10/15-06/18	KIT 	313 432 900 113		120	24.0	10.5	85	1900	im KIT enthalten 313 432 300 113	-06/18	S	CAN	C	E	D	L1	H	45
Mercedes C-Klasse Coupé C205 nicht für AMG C63, AMG C63S auch für AMG-Optik-Paket nicht für Kfz. mit Niveauregulierung	10/15-03/23		313 431 600 001		120	21.0	10.5	85	1900	313 432 300 107 313 432 300 113 313 445 300 113	-06/18	S	CAN	C	E	--	--	H	45
					-06/18	S	CAN	C	E		D	L1	H	45					
					07/18-03/23 inkl. WLC 2.0	S	FRE	C	E		D	L1	H	60					



















Mercedes-Benz











Mercedes-Benz

Mercedes C-Klasse Coupé C205 nicht für AMG C63, AMG C63S auch für AMG-Optik-Paket auch für Kfz. mit Niveauregulierung	10/15-03/23		313 432 600 001		120	23.0	10.5	85	1900		313 432 300 107	-06/18	S	CAN	C	E	--	--	H	45			
														313 432 300 113	-06/18	S	CAN	C	E	D	L1	H	45
															313 445 300 113	07/18-03/23 inkl. WLC 2.0	S	FRE	C	E	D	L1	H
Mercedes C-Klasse Coupé C205 nicht für AMG C63, AMG C63S auch für AMG-Optik-Paket nicht für Kfz. mit Niveauregulierung	07/18-03/23	KIT		313 445 900 113		120	29.1	10.5	85	1900	im KIT enthalten 313 445 300 113	07/18-03/23 inkl. WLC 2.0	S	FRE	C	E	D	L1	H	60			
Mercedes C-Klasse Coupé C205 nicht für AMG C63, AMG C63S auch für AMG-Optik-Paket auch für Kfz. mit Niveauregulierung	07/18-03/23	KIT		313 446 900 113		120	29.1	10.5	85	1900	im KIT enthalten 313 445 300 113	07/18-03/23 inkl. WLC 2.0	S	FRE	C	E	D	L1	H	60			
Mercedes C-Klasse Kombi S203 mit Stahlfedern nicht für Sport-Coupé, CLK ab 05/02, AMG und Allrad	06/01-09/07			313 166 600 001		>150	22.0	9.1	75	1600	313 168 300 113		S	CAN	C	E	D	--	H	60			
							313 167 600 001	>150	23.8	9.1											75	1600	
		KIT		313 166 900 113	>150			24.0	9.1	75	1600	im KIT enthalten 313 168 300 113											
					KIT		313 167 900 113	>150	25.5	9.1	75		1600	im KIT enthalten 313 168 300 113									













Mercedes C-Klasse Kombi S204 nicht für Kfz. mit Niveauregulierung, nicht für AMG- Fahrzeuge auch für Fahrzeuge mit AMG- Optik-Paket (=> sichtbarer Stoßfängerausschnitt)	09/07-07/09	KIT		313 214 900 113		>150	23.0	10.2	75	1900			-07/09 Falls ein SAM-Low Steuergerät verbaut ist, muss dieses gegen ein hochwertigeres SAM-High ausgetauscht werden. Beachten Sie die Herstellervorgaben.	S	CAN	C	E	D	L	H	45												
		KIT		313 315 900 113		>150	25.0	10.2	75	1900												im KIT enthalten 313 210 300 113											
Mercedes C-Klasse Kombi S204 nicht für Kfz. mit Niveauregulierung, nicht für AMG- Fahrzeuge auch für Fahrzeuge mit AMG- Optik-Paket (=> sichtbarer Stoßfängerausschnitt)	09/07-08/14			313 214 600 001		>150	21.0	10.2	75	1900			-07/09 Falls ein SAM-Low Steuergerät verbaut ist, muss dieses gegen ein hochwertigeres SAM-High ausgetauscht werden. Beachten Sie die Herstellervorgaben.	S	CAN	C	E	D	L	H	45												
				313 438 600 001		120	23.0	10.2	75	1900												313 210 300 113											
																								313 361 300 107	07/09-	S	CAN	C	E	--	--	H	45
													07/09-	S	CAN	C	E	D	L	H	45												
Mercedes C-Klasse Kombi S204 für Kfz. mit Niveauregulierung nicht für AMG-Fahrzeuge auch für Fahrzeuge mit AMG- Optik-Paket (=> sichtbarer Stoßfängerausschnitt)	09/07-08/14			313 439 600 001			120	23.0	10.2	75	1900			-07/09 Falls ein SAM-Low Steuergerät verbaut ist, muss dieses gegen ein hochwertigeres SAM-High ausgetauscht werden. Beachten Sie die Herstellervorgaben.	S	CAN	C	E	D	L	H	45											
																								313 361 300 107	07/09-	S	CAN	C	E	--	--	H	45
																										07/09-	S	CAN	C	E	D	L	H





















Mercedes-Benz

Mercedes C-Klasse Kombi S204 nicht für Kfz. mit Niveauregulierung, nicht für AMG-Fahrzeuge auch für Fahrzeuge mit AMG-Optik-Paket (=> sichtbarer Stoßfängerausschnitt)	07/09-08/14	KIT		313 389 900 113		>150	23.0	10.2	75	1900		im KIT enthalten 313 361 300 113	07/09-	S	CAN	C	E	D	L	H	45
		KIT		313 211 900 113		>150	25.0	10.2	75	1900		im KIT enthalten 313 361 300 113	07/09-	S	CAN	C	E	D	L	H	45
Mercedes C-Klasse Kombi S205 nicht für AMG C63, AMG C63S auch für AMG-Optik-Paket nicht für Kfz. mit Niveauregulierung	09/14-06/18	KIT		313 431 900 113		120	23.0	10.5	85	1900		im KIT enthalten 313 432 300 113	-06/18	S	CAN	C	E	D	L1	H	45
Mercedes C-Klasse Kombi S205 nicht für AMG C63, AMG C63S auch für AMG-Optik-Paket auch für Kfz. mit Niveauregulierung	09/14-06/18	KIT		313 432 900 113		120	24.0	10.5	85	1900		im KIT enthalten 313 432 300 113	-06/18	S	CAN	C	E	D	L1	H	45
Mercedes C-Klasse Kombi S205 nicht für AMG C63, AMG C63S auch für AMG-Optik-Paket nicht für Kfz. mit Niveauregulierung	09/14-02/21			313 431 600 001		120	21.0	10.5	85	1900		313 432 300 107	-06/18	S	CAN	C	E	--	--	H	45
												313 432 300 113	-06/18	S	CAN	C	E	D	L1	H	45
												313 445 300 113	07/18- inkl. WLC 2.0	S	FRE	C	E	D	L1	H	60
Mercedes C-Klasse Kombi S205 nicht für AMG C63, AMG C63S auch für AMG-Optik-Paket auch für Kfz. mit Niveauregulierung	09/14-02/21			313 432 600 001		120	23.0	10.5	85	1900		313 432 300 107	-06/18	S	CAN	C	E	--	--	H	45
												313 432 300 113	-06/18	S	CAN	C	E	D	L1	H	45
												313 445 300 113	07/18- inkl. WLC 2.0	S	FRE	C	E	D	L1	H	60
Mercedes C-Klasse Kombi S205 nicht für AMG C63, AMG C63S auch für AMG-Optik-Paket nicht für Kfz. mit Niveauregulierung	07/18-02/21	KIT		313 445 900 113		120	29.1	10.5	85	1900		im KIT enthalten 313 445 300 113	07/18- inkl. WLC 2.0	S	FRE	C	E	D	L1	H	60
Mercedes C-Klasse Kombi S205 nicht für AMG C63, AMG C63S auch für AMG-Optik-Paket auch für Kfz. mit Niveauregulierung	07/18-02/21	KIT		313 446 900 113		120	29.1	10.5	85	1900		im KIT enthalten 313 445 300 113	07/18- inkl. WLC 2.0	S	FRE	C	E	D	L1	H	60
Mercedes C-Klasse Kombi S206 nicht für AMG nicht für Plugin-Hybrid	03/21-			313 709 600 001		90	18.3	10.1	120	1800											

Mercedes C-Klasse Limousine W203 mit Stahlfedern nicht für Sport-Coupé, CLK ab 05/02, AMG	06/00-03/07		313 166 600 001			>150	22.0	9.1	75	1600									S	CAN	C	E	D	--	H	60
			313 167 600 001			>150	23.8	9.1	75	1600										S	CAN	C	E	D	--	H
	KIT		313 166 900 113			>150	24.0	9.1	75	1600		im KIT enthalten 313 168 300 113							S	CAN	C	E	D	--	H	60
	KIT		313 167 900 113			>150	25.5	9.1	75	1600		im KIT enthalten 313 168 300 113							S	CAN	C	E	D	--	H	60
Mercedes C-Klasse Limousine W204 nicht für Kfz. mit Niveauregulierung nicht für AMG-Fahrzeuge, AMG-Optik-Paket	03/07-07/09	KIT		313 214 900 113		>150	23.0	10.2	75	1900		im KIT enthalten 313 210 300 113							S	CAN	C	E	D	L	H	45
		KIT		313 315 900 113		>150	25.0	10.2	75	1900																
Mercedes C-Klasse Limousine W204 nicht für Kfz. mit Niveauregulierung, nicht für AMG-Fahrzeuge auch für Fahrzeuge mit AMG-Optik-Paket (=> sichtbarer Stoßfängerausschnitt)	03/07-01/14		313 214 600 001			>150	21.0	10.2	75	1900		313 210 300 113							S	CAN	C	E	D	L	H	45
												313 361 300 107	07/09-	S	CAN	C	E	--	--	H	45					
													313 361 300 113	07/09-	S	CAN	C	E	D	L	H	45				

















Mercedes-Benz

Mercedes C-Klasse Limousine W204 nicht für Kfz. mit Niveauregulierung nicht für AMG-Fahrzeuge, AMG- Optik-Paket	03/07-01/14		313 438 600 001		120	23.0	10.2	75	1900		313 210 300 113	-07/09 Falls ein SAM-Low Steuergerät verbaut ist, muss dieses gegen ein hochwertigeres SAM-High ausgetauscht werden. Beachten Sie die Herstellervorgaben.	S	CAN	C	E	D	L	H	45	
											313 361 300 107	07/09-	S	CAN	C	E	--	--	H	45	
											313 361 300 113	07/09-	S	CAN	C	E	D	L	H	45	
Mercedes C-Klasse Limousine W204 für Kfz. mit Niveauregulierung nicht für AMG-Fahrzeuge	03/07-01/14		313 439 600 001			120	23.0	10.2	75	1900		313 210 300 113	-07/09 Falls ein SAM-Low Steuergerät verbaut ist, muss dieses gegen ein hochwertigeres SAM-High ausgetauscht werden. Beachten Sie die Herstellervorgaben.	S	CAN	C	E	D	L	H	45
												313 361 300 107	07/09-	S	CAN	C	E	--	--	H	45
												313 361 300 113	07/09-	S	CAN	C	E	D	L	H	45
Mercedes C-Klasse Limousine W204 nicht für Kfz. mit Niveauregulierung nicht für AMG-Fahrzeuge, AMG- Optik-Paket	07/09-01/14	KIT		313 389 900 113		>150	23.0	10.2	75	1900		im KIT enthalten 313 361 300 113	07/09-	S	CAN	C	E	D	L	H	45
												KIT		313 211 900 113		>150	25.0	10.2	75	1900	
Mercedes C-Klasse Limousine W205 nicht für AMG C63, AMG C63S auch für AMG-Optik-Paket nicht für Kfz. mit Niveauregulierung	03/14-06/18	KIT		313 431 900 113		120	23.0	10.5	85	1900		im KIT enthalten 313 432 300 113	-06/18	S	CAN	C	E	D	L1	H	45
Mercedes C-Klasse Limousine W205 nicht für AMG C63, AMG C63S auch für AMG-Optik-Paket auch für Kfz. mit Niveauregulierung	03/14-06/18	KIT		313 432 900 113		120	24.0	10.5	85	1900		im KIT enthalten 313 432 300 113	-06/18	S	CAN	C	E	D	L1	H	45















Mercedes C-Klasse Limousine W205 nicht für AMG C63, AMG C63S auch für AMG-Optik-Paket nicht für Kfz. mit Niveauregulierung	03/14-02/21		313 431 600 001		120	21.0	10.5	85	1900	313 432 300 107	-06/18	S	CAN	C	E	--	--	H	45																
					313 432 300 113	-06/18	S	CAN	C		E	D	L1	H	45																				
					313 445 300 113	07/18-02/21 inkl. WLC 2.0	S	FRE	C		E	D	L1	H	60																				
Mercedes C-Klasse Limousine W205 nicht für AMG C63, AMG C63S auch für AMG-Optik-Paket auch für Kfz. mit Niveauregulierung	03/14-02/21		313 432 600 001		120	23.0	10.5	85	1900	313 432 300 107	-06/18	S	CAN	C	E	--	--	H	45																
					313 432 300 113	-06/18	S	CAN	C		E	D	L1	H	45																				
					313 445 300 113	07/18-02/21 inkl. WLC 2.0	S	FRE	C		E	D	L1	H	60																				
Mercedes C-Klasse Limousine W205 nicht für AMG C63, AMG C63S auch für AMG-Optik-Paket nicht für Kfz. mit Niveauregulierung	07/18-02/21	KIT		313 445 900 113		120	29.1	10.5	85	1900	im KIT enthalten 313 445 300 113	07/18-02/21 inkl. WLC 2.0	S	FRE	C	E	D	L1	H	60															
Mercedes C-Klasse Limousine W205 nicht für AMG C63, AMG C63S auch für AMG-Optik-Paket auch für Kfz. mit Niveauregulierung	07/18-02/21	KIT		313 446 900 113		120	29.1	10.5	85	1900	im KIT enthalten 313 445 300 113	07/18-02/21 inkl. WLC 2.0	S	FRE	C	E	D	L1	H	60															
Mercedes C-Klasse Limousine W206 nicht für AMG nicht für Plugin-Hybrid	03/21-		313 709 600 001		90	18.3	10.1	120	1800																										
						313 710 600 001		90	21.7												10.1	120	1800												
Mercedes CLA C117 auch für KFZ mit AMG Optik Paket auch für CLA Shooting Brake (X117) 03/15- Achtung: Je nach Motorvariante können Änderungen am Kühlsystem des Fahrzeugs notwendig sein.	04/13-03/19		313 396 600 001		60	23.0	9.2	80	1500	313 398 300 107			S	CAN	C	E	--	--	V	105															
						313 503 600 001		60	24.5												10.2	80	1900	313 398 300 113	S	CAN	C	E	D	L	V	105			
					KIT		313 396 900 113		60												25.0	9.2	80	1900	im KIT enthalten 313 398 300 113			S	CAN	C	E	D	L	V	105
					KIT		313 400 900 113		60												26.0	10.2	80	1900	im KIT enthalten 313 398 300 113			S	CAN	C	E	D	L	V	105
Mercedes CLA II Coupé C118 auch für AMG nicht für Fzg. mit Aerodynamikpaket	04/19-		313 640 600 001		60	26.7	10.7	120	2100	313 215 300 113	04/19- für Fahrzeuge ohne Vorrüstung	S	CAN	C	E	D	L	V	75																





















Mercedes-Benz

Mercedes-Benz

Mercedes CLA II Coupé C118 auch für AMG nicht für Fzg. mit Aerodynamikpaket	04/19-			313 639 600 001		60	25.3	10.7	120	2100		313 215 300 113	04/19- für Fahrzeuge ohne Vorrüstung	S	CAN	C	E	D	L	V	75	
Mercedes CLA II Coupé C118 für Fzg. ohne Vorrüstung auch für AMG nicht für Fzg. mit Aerodynamikpaket	04/19-	KIT		313 639 900 113		60	24.9	10.7	120	2100		im KIT enthalten 313 215 300 113	04/19- für Fahrzeuge ohne Vorrüstung	S	CAN	C	E	D	L	V	75	
				313 640 900 113		60	28.3	10.7	120	2100		im KIT enthalten 313 215 300 113	04/19- für Fahrzeuge ohne Vorrüstung	S	CAN	C	E	D	L	V	75	
Mercedes CLA II Shooting Brake X118 auch für AMG nicht für Fzg. mit Aerodynamikpaket	06/19-			313 639 600 001		60	25.3	10.7	120	2100		313 215 300 113	für Fahrzeuge ohne Vorrüstung	S	CAN	C	E	D	L	V	75	
				313 640 600 001		60	26.7	10.7	120	2100												
Mercedes CLA II Shooting Brake X118 für Fzg. ohne Vorrüstung auch für AMG nicht für Fzg. mit Aerodynamikpaket	06/19-	KIT		313 639 900 113		60	24.9	10.7	120	2100		im KIT enthalten 313 215 300 113	für Fahrzeuge ohne Vorrüstung	S	CAN	C	E	D	L	V	75	
				313 640 900 113		60	28.3	10.7	120	2100		im KIT enthalten 313 215 300 113	für Fahrzeuge ohne Vorrüstung	S	CAN	C	E	D	L	V	75	
Mercedes CLC ist vom Hersteller nicht für den Anhängerbetrieb freigegeben.																						
Mercedes CLS Shooting Brake X218 auch für Fahrzeuge mit AMG- Optik-Paket	10/12-12/17			313 371 600 001		150	26.0	11.5	84	2100		313 361 300 107		S	CAN	C	E	--	--	H	45	
				313 373 600 001		150	27.0	11.5	84	2100		313 361 300 113		S	CAN	C	E	D	L	H	45	
		KIT		313 371 900 113		150	30.6	11.5	84	2100		im KIT enthalten 313 361 300 113		S	CAN	C	E	D	L	H	45	
		KIT		313 373 900 113		150	32.5	11.5	84	2100		im KIT enthalten 313 361 300 113		S	CAN	C	E	D	L	H	45	

























Mercedes-Benz









Mercedes E-Klasse Kombi S212 auch für AMG-Styling	09/09-03/16		313 371 600 001			150	26.0	11.5	84	2100		313 361 300 107			S	CAN	C	E	--	--	H	45	
			313 373 600 001			150	27.0	11.5	84	2100		313 361 300 113			S	CAN	C	E	D	L	H	45	
		KIT		313 371 900 113			150	30.6	11.5	84	2100		im KIT enthalten 313 361 300 113			S	CAN	C	E	D	L	H	45
		KIT		313 373 900 113			150	32.5	11.5	84	2100		im KIT enthalten 313 361 300 113			S	CAN	C	E	D	L	H	45
Mercedes E-Klasse Kombi S213 auch für KFZ mit AMG Optik Paket Plug-in-Hybrid: Bitte D-Wert beachten! auch für Facelift 2021- nicht für E63 AMG	04/16-08/23		313 523 600 001		60	23.8	11.8	140	2100		313 446 300 113	-08/23		S	CAN	C	E	D	L	H	60		
			313 524 600 001		60	25.1	11.8	140	2100														
		KIT		313 523 900 113		60	24.7	11.8	140	2100		im KIT enthalten 313 446 300 113	-08/23		S	CAN	C	E	D	L	H	60	
		KIT		313 524 900 113		60	26.0	11.8	140	2100		im KIT enthalten 313 446 300 113	-08/23		S	CAN	C	E	D	L	H	60	
Mercedes E-Klasse Limousine W211 nicht für AMG-Fahrzeuge, auch für 4-Matic Falls nicht vorhanden, müssen links und rechts im Kofferraum zusätzlich Verstärkungsstreben montiert werden. Diese können beim DC-Händler erworben werden, DC-Nr. A2116390143 und A2116390443. Durch die Montage o.g. Streben passen die Verkleidungen nicht mehr. Je nach Ausstattungslinie können verschiedene Verkleidungen beim DC-Händler erworben werden, z.B. A2116909425 / 9825. Der Gebläsemotor der Kühlung muss eine Mindestleistung von 600 W haben. Die Gebläsemotoren A0015004493 und A2115000693 erfüllen diese Anforderungen.	03/02-09		313 195 600 001			150	24.5	11.0	80	2000		313 196 300 113			S	CAN	C	E	D	--	H	60	
		KIT		313 195 900 113			150	25.0	11.0	80	2000		im KIT enthalten 313 196 300 113			S	CAN	C	E	D	--	H	60

Mercedes E-Klasse Limousine W212	03/09-12/15		313 361 600 001			90	31.0	11.4	84	2100		313 361 300 107			S	CAN	C	E	--	--	H	45	
												313 361 300 113			S	CAN	C	E	D	L	H	45	
		KIT		313 361 900 113			90	32.0	11.4	84	2100		im KIT enthalten 313 361 300 113			S	CAN	C	E	D	L	H	45
Mercedes E-Klasse Limousine W213 auch für KFZ mit AMG Optik Paket Plug-in-Hybrid: Bitte D-Wert beachten! auch für Facelift 2021- nicht für E63 AMG	01/16-08/23		313 523 600 001			60	23.8	11.8	140	2100													
				313 524 600 001			60	25.1	11.8	140	2100		313 446 300 113	-08/23		S	CAN	C	E	D	L	H	60
		KIT		313 523 900 113			60	24.7	11.8	140	2100		im KIT enthalten 313 446 300 113	-08/23		S	CAN	C	E	D	L	H	60
		KIT		313 524 900 113			60	26.0	11.8	140	2100		im KIT enthalten 313 446 300 113	-08/23		S	CAN	C	E	D	L	H	60
Mercedes EQC N293	05/19-		313 562 600 001			60	26.7	13.3	160	2600		313 445 300 113	05/19- 2.0	inkl. WLC	S	FRE	C	E	D	L1	H	60	
Mercedes EQV W447	06/20-		313 435 600 001			90	20.0	13.8	100	2500													
				313 436 600 001			90	21.0	13.8	100	2500												
Mercedes G-Klasse nur für Kfz. mit zweiteiligem Stoßfänger	02/90-		313 320 600 001			60	12.0	17.2	140	3500		300 210 300 113			--	A	--	E1	D1	L1	V	90	
Mercedes GL X164/X166 auch für 8-Zylinder Diesel nicht für Fahrzeuge mit AMG- Optik-Paket für Fahrzeuge mit AD Blue Tank bitte zusätzlich bestellen: Halter 913406609103	09/06-12/15		313 421 600 001			120	38.0	16.5	135	3500		313 138 300 113		X164: Bitte Steuergerät + Relais beim DC- Händler bestellen.	S	CAN	C	E	D	L	H	45	
												313 430 300 113		X166	S	CAN	C1	E	D	L1	H	60	
Mercedes GLA X156 nicht für Fahrzeuge mit AMG- Optik-Paket	03/14-12/19		313 401 600 001			60	21.0	10.2	80	1900		313 398 300 107			S	CAN	C	E	--	--	V	105	
												313 398 300 113			S	CAN	C	E	D	L	V	105	
		KIT		313 401 900 113		60	24.0	10.2	80	1900		im KIT enthalten 313 398 300 113			S	CAN	C	E	D	L	V	105	























Mercedes-Benz











Mercedes-Benz

Mercedes GLA X156 auch für Fahrzeuge mit AMG-Optik-Paket (Stoßfängerausschnitt erforderlich)	03/14-12/19			313 503 600 001		60	24.5	10.2	80	1900		313 398 300 107			S	CAN	C	E	--	--	V	105
		KIT		313 400 900 113		60	26.0	10.2	80	1900		im KIT enthalten 313 398 300 113			S	CAN	C	E	D	L	V	105
Mercedes GLA (H247) auch für Hybrid auch für AdBlue auch für GLA 35 + 45 AMG nicht für Fzg. mit Aerodynamikpaket	02/20-			313 639 600 001		60	25.3	10.7	120	2100		313 215 300 113	für Fahrzeuge ohne Vorrüstung	S	CAN	C	E	D	L	V	75	
				313 640 600 001		60	26.7	10.7	120	2100												
Mercedes GLA (H247) für Fzg. ohne Vorrüstung auch für Hybrid auch für AdBlue auch für GLA 35 + 45 AMG nicht für Fzg. mit Aerodynamikpaket	02/20-	KIT		313 639 900 113		60	24.9	10.7	120	2100		im KIT enthalten 313 215 300 113	für Fahrzeuge ohne Vorrüstung	S	CAN	C	E	D	L	V	75	
		KIT		313 640 900 113		60	28.3	10.7	120	2100		im KIT enthalten 313 215 300 113	für Fahrzeuge ohne Vorrüstung	S	CAN	C	E	D	L	V	75	
Mercedes GLB (X247) auch für Hybrid auch für AdBlue auch für GLB 35 AMG	08/19-			313 639 600 001		60	25.3	10.7	120	2100		313 215 300 113	für Fahrzeuge ohne Vorrüstung	S	CAN	C	E	D	L	V	75	
				313 640 600 001		60	26.7	10.7	120	2100												
Mercedes GLB (X247) für Fzg. ohne Vorrüstung auch für Hybrid auch für AdBlue auch für GLB 35 AMG	08/19-	KIT		313 639 900 113		60	24.9	10.7	120	2100		im KIT enthalten 313 215 300 113	für Fahrzeuge ohne Vorrüstung	S	CAN	C	E	D	L	V	75	
		KIT		313 640 900 113		60	28.3	10.7	120	2100		im KIT enthalten 313 215 300 113	für Fahrzeuge ohne Vorrüstung	S	CAN	C	E	D	L	V	75	
Mercedes GLC X253 auch für Fzg. mit Niveauregulierung auch für Fahrzeuge mit AMG- Optik-Paket Fahrzeuge mit Heckklappensensor: bitte Einbauanleitung beachten - Sensorleitung muss angepasst werden. Nur für Hybrid: Rahmenverstärkungssatz beim Fahrzeughersteller bestellen!	09/15-06/19	KIT		313 402 900 113		90	24.4	13.2	100	2500		im KIT enthalten 313 432 300 113	-06/19	S	CAN	C	E	D	L1	H	45	
		KIT		313 403 900 113		90	27.6	13.2	100	2500		im KIT enthalten 313 432 300 113	-06/19	S	CAN	C	E	D	L1	H	45	





Mercedes GLC X253 auch für Fzg. mit Niveauregulierung auch für Fahrzeuge mit AMG-Optik-Paket Fahrzeuge mit Heckklappensensor: bitte Einbauanleitung beachten - Sensorleitung muss angepasst werden. Nur für Hybrid: Rahmenverstärkungssatz beim Fahrzeughersteller bestellen!	09/15-05/22		313 402 600 001		90	23.0	13.2	100	2500		313 432 300 107	-06/19	S	CAN	C	E	--	--	H	45	
											313 432 300 113	-06/19	S	CAN	C	E	D	L1	H	45	
											313 445 300 113	07/19- inkl. WLC 2.0	S	FRE	C	E	D	L1	H	60	
Mercedes GLC X253 auch für Fzg. mit Niveauregulierung auch für Fahrzeuge mit AMG-Optik-Paket Fahrzeuge mit Heckklappensensor: bitte Einbauanleitung beachten - Sensorleitung muss angepasst werden. Nur für Hybrid: Rahmenverstärkungssatz beim Fahrzeughersteller bestellen!	09/15-05/22		313 403 600 001		90	25.0	13.2	100	2500		313 432 300 107	-06/19	S	CAN	C	E	--	--	H	45	
											313 432 300 113	-06/19	S	CAN	C	E	D	L1	H	45	
											313 445 300 113	07/19- inkl. WLC 2.0	S	FRE	C	E	D	L1	H	60	
Mercedes GLC X253 auch für Fzg. mit Niveauregulierung auch für Fahrzeuge mit AMG-Optik-Paket Fahrzeuge mit Heckklappensensor: bitte Einbauanleitung beachten - Sensorleitung muss angepasst werden. Nur für Hybrid: Rahmenverstärkungssatz beim Fahrzeughersteller bestellen!	07/19-05/22	KIT		313 404 900 113		60	24.4	13.2	100	2500		im KIT enthalten 313 445 300 113	07/19- inkl. WLC 2.0	S	FRE	C	E	D	L1	H	60
Mercedes GLC X253 auch für Fzg. mit Niveauregulierung auch für Fahrzeuge mit AMG-Optik-Paket Fahrzeuge mit Heckklappensensor: bitte Einbauanleitung beachten - Sensorleitung muss angepasst werden. Nur für Hybrid: Rahmenverstärkungssatz beim Fahrzeughersteller bestellen!	07/19-07/22	KIT		313 405 900 113		60	27.6	13.2	100	2500		im KIT enthalten 313 445 300 113	07/19- inkl. WLC 2.0	S	FRE	C	E	D	L1	H	60





Mercedes-Benz

Mercedes GLE W166 auch für Fahrzeuge mit AMG-Optik-Paket nicht für GLE Coupé	04/15-09/18			313 406 600 001		90	50.0	16.8	140	3500		313 430 300 113	-09/18	S	CAN	C1	E	D	L1	H	60	
		KIT		313 406 900 113		90	51.8	16.8	140	3500		im KIT enthalten 313 430 300 113	-09/18	S	CAN	C1	E	D	L1	H	60	
Mercedes GLE V167 / W167 nicht für Hybrid auch für AMG	10/18-			313 661 600 001		60	34.4	16.0	140	3500		313 446 300 113	10/18- inkl. WLC 2.0	S	CAN	C	E	D	L	H	60	
				313 662 600 001		60	37.3	16.0	140	3500												
		KIT		313 661 900 113		60	36.1	16.0	140	3500		im KIT enthalten 313 446 300 113	10/18- inkl. WLC 2.0	S	CAN	C	E	D	L	H	60	
		KIT		313 662 900 113		60	38.0	16.0	140	3500		im KIT enthalten 313 446 300 113	10/18- inkl. WLC 2.0	S	CAN	C	E	D	L	H	60	
Mercedes GLE Coupé C292	03/15-10/19			313 515 600 001		90	40.5	16.8	140	3500		313 430 300 113		S	CAN	C1	E	D	L1	H	60	
Mercedes GLK X204	06/08-12/15			313 433 600 001		90	22.0	12.8	100	2500		313 210 300 113	-07/09 Falls ein SAM-Low Steuergerät verbaut ist, muss dieses gegen ein hochwertigeres SAM-High ausgetauscht werden. Beachten Sie die Herstellervorgaben.	S	CAN	C	E	D	L	H	45	
				313 434 600 001		90	23.0	12.8	100	2500												
													313 361 300 107	07/09-	S	CAN	C	E	--	--	H	45
											313 361 300 113	07/09-	S	CAN	C	E	D	L	H	45		
Mercedes GLK X204	07/09-12/15	KIT		313 433 900 113		90	24.0	12.8	100	2500		im KIT enthalten 313 361 300 113	07/09-	S	CAN	C	E	D	L	H	45	
		KIT		313 434 900 113		90	27.0	12.8	100	2500		im KIT enthalten 313 361 300 113	07/09-	S	CAN	C	E	D	L	H	45	







Mercedes GLS X166 auch für 8-Zylinder Diesel nicht für Fahrzeuge mit AMG- Optik-Paket für Fahrzeuge mit AD Blue Tank bitte zusätzlich bestellen: Halter 913406609103	01/16-04/19			313 421 600 001		120	38.0	16.5	135	3500		313 430 300 113			S	CAN	C1	E	D	L1	H	60	
Mercedes M-Klasse W163 nicht für Kfz. mit Reserverad auf der Heckklappe. Für Fzg. -2000 wird empfohlen, den Stoßfänger mit Ausschnitt und Abdeckklappe der Modelle 2000-2002 beim Mercedes-Benz- Händler zu bestellen. Für Fzg. 2000- muss der vorhandene Stoßfänger ausgeschnitten werden. Abdeckklappe für Stoßfängerausschnitt bitte beim Mercedes-Händler bestellen.	98-07/05			313 179 600 001		90	15.0	16.0	150	3500													
Mercedes M-Klasse W164	07/05-11/11			313 341 600 001		120	38.0	16.0	135	3500		313 138 300 113		Bitte Steuergerät + Relais beim DC- Händler bestellen.	S	CAN	C	E	D	L	H	45	
				313 340 600 001		120	39.0	16.0	135	3500													
Mercedes M-Klasse W166 nicht für Fahrzeuge mit AMG- Optik-Paket	06/11-12/15			313 406 600 001		90	50.0	16.8	140	3500		313 430 300 113			S	CAN	C1	E	D	L1	H	60	
		KIT		313 406 900 113		90	51.8	16.8	140	3500		im KIT enthalten 313 430 300 113			S	CAN	C1	E	D	L1	H	60	
Mercedes SLK ist vom Hersteller nicht für den Anhängerbetrieb freigegeben.																							
Mercedes Sprinter I Die Aufstellung zum Mercedes Sprinter finden Sie im Anhang.	03/96-03/06																						







Mercedes-Benz

<p>Mercedes Sprinter Kasten/ Kombi für Fzg. ohne Vorrüstung Typen 209-224 und 309-324 Fzg. mit 3,0 und 3,5 t zGG, Auflastung auf 3,8 t zGG möglich bei Fzg. mit Stoßfänger mit integrierter Trittstufe muss das mittlere Teil der Außenhaut ausgetauscht werden (erhältlich beim Mercedes-Händler) inkl. Kugelplatte Auftritt DC-IR A906 520 0531 kann nicht verwendet werden. Passende Trittstufe: 313285600001 / 313440600001</p>	04/06-12/14	KIT		313 376 900 113		120	22.0	18.1	150	3500		im KIT enthalten 313 105 300 113		-12/14 für Fzg. ohne Vorrüstung	S	CAN	C	E	D1	--	V	90
<p>Mercedes Sprinter Kasten/ Kombi für Fzg. ohne Vorrüstung Typen 209-224 und 309-324 mit Trittstufe Fzg. mit 3,0 und 3,5 t zGG, Auflastung auf 3,8 t zGG möglich passende Kugelplatte: 329076600001 nicht für Radstand = 3250 mm</p>	04/06-12/14	KIT		313 105 900 113		60	34.0	17.6	120	2800		im KIT enthalten 313 105 300 113		-12/14 für Fzg. ohne Vorrüstung	S	CAN	C	E	D1	--	V	90
<p>Mercedes Sprinter Kasten/ Kombi Typen 411-424 und 509-524 Fzg. mit 5,0 t zGG, Ablastung auf 4,6 t zGG möglich Radstand: 3665 mm bei Fzg. mit Stoßfänger mit integrierter Trittstufe muss das mittlere Teil der Außenhaut ausgetauscht werden (erhältlich beim Mercedes-Händler) passende Kugelplatte: 329141600001 Auftritt DC-IR A906 520 0531 kann nicht verwendet werden. Passende Trittstufe: 313285600001 / 313440600001</p>	04/06-01/18			313 272 600 001		120	22.0	20.2	150	3500		313 105 300 107	→	-12/14 für Fzg. ohne Vorrüstung	S	CAN	C	E	--	--	V	90
												313 105 300 113		-12/14 für Fzg. ohne Vorrüstung	S	CAN	C	E	D1	--	V	90
												313 107 300 113		01/15-01/18 für Fzg. mit Vorrüstung	S	CAN	C	E	D1	L1	H	45
												313 108 300 113		01/15-01/18 für Fzg. ohne Vorrüstung	S	CAN	C	E	D1	L1	V	90
												321 106 300 113		-12/14 für Fzg. mit Vorrüstung	S	CAN	C	E	D	--	H	45





Mercedes Sprinter Kasten/ Kombi Typen 411-424 und 509-524 Fzg. mit 5,0 t zGG, Ablastung auf 4,6 t zGG möglich Radstand: 4325 mm bei Fzg. mit Stoßfänger mit integrierter Trittstufe muss das mittlere Teil der Außenhaut ausgetauscht werden (erhältlich beim Mercedes-Händler) passende Kugelplatte: 329141600001 Auftritt DC-IR A906 520 0531 kann nicht verwendet werden. Passende Trittstufe: 313285600001 / 313440600001	04/06-01/18		313 273 600 001		120	23.0	20.2	150	3500	313 105 300 107	→	-12/14 für Fzg. ohne Vorrüstung	S	CAN	C	E	--	--	V	90
										313 105 300 113		-12/14 für Fzg. ohne Vorrüstung	S	CAN	C	E	D1	--	V	90
										313 107 300 113		01/15-01/18 für Fzg. mit Vorrüstung	S	CAN	C	E	D1	L1	H	45
										313 108 300 113		01/15-01/18 für Fzg. ohne Vorrüstung	S	CAN	C	E	D1	L1	V	90
										321 106 300 113		-12/14 für Fzg. mit Vorrüstung	S	CAN	C	E	D	--	H	45
Mercedes Sprinter Kasten/ Kombi Typen 209-224 und 309-324 Frontradantrieb -01/18 Fzg. mit 3,0 und 3,5 t zGG, Auflastung auf 3,8 t zGG möglich bei Fzg. mit Stoßfänger mit integrierter Trittstufe muss das mittlere Teil der Außenhaut ausgetauscht werden (erhältlich beim Mercedes-Händler) passende Kugelplatte: 329141600001 Auftritt DC-IR A906 520 0531 kann nicht verwendet werden. Passende Trittstufe: 313285600001 / 313440600001	04/06-01/18		313 376 600 001		120	20.0	18.1	150	3500	313 105 300 107	→	-12/14 für Fzg. ohne Vorrüstung	S	CAN	C	E	--	--	V	90
										313 105 300 113		-12/14 für Fzg. ohne Vorrüstung	S	CAN	C	E	D1	--	V	90
										313 107 300 113		01/15-01/18 für Fzg. mit Vorrüstung	S	CAN	C	E	D1	L1	H	45
										313 108 300 113		01/15-01/18 für Fzg. ohne Vorrüstung	S	CAN	C	E	D1	L1	V	90
										321 106 300 113		-12/14 für Fzg. mit Vorrüstung	S	CAN	C	E	D	--	H	45
Mercedes Sprinter Kasten/ Kombi Typen 209-224 und 309-324 mit Trittstufe Fzg. mit 3,0 und 3,5 t zGG, Auflastung auf 3,8 t zGG möglich passende Kugelplatte: 329076600001 nicht für Radstand = 3250 mm	04/06-01/18		313 553 600 001		60	31.8	17.6	120	2800	313 105 300 107	→	-12/14 für Fzg. ohne Vorrüstung	S	CAN	C	E	--	--	V	90
										313 105 300 113		-12/14 für Fzg. ohne Vorrüstung	S	CAN	C	E	D1	--	V	90
										313 107 300 113		01/15-01/18 für Fzg. mit Vorrüstung	S	CAN	C	E	D1	L1	H	45
										313 108 300 113		01/15-01/18 für Fzg. ohne Vorrüstung	S	CAN	C	E	D1	L1	V	90
										321 106 300 113		-12/14 für Fzg. mit Vorrüstung	S	CAN	C	E	D	--	H	45



















Mercedes-Benz

Mercedes Sprinter Kasten/ Kombi für Fzg. ohne Vorrüstung Typen 209-224 und 309-324 Fzg. mit 3,0 und 3,5 t zGG, Auflastung auf 3,8 t zGG möglich bei Fzg. mit Stoßfänger mit integrierter Trittstufe muss das mittlere Teil der Außenhaut ausgetauscht werden (erhältlich beim Mercedes-Händler) inkl. Kugelplatte Auftritt DC-IR A906 520 0531 kann nicht verwendet werden. Passende Trittstufe: 313285600001 / 313440600001	01/15-01/18	KIT		313 108 900 113		120	23.0	18.1	150	3500		im KIT enthalten 313 108 300 113		01/15-01/18 für Fzg. ohne Vorrüstung	S	CAN	C	E	D1	L1	V	90
Mercedes Sprinter Kasten/ Kombi für Fzg. ohne Vorrüstung inkl. Kugelplatte Typen 209-224 und 309-324 mit Trittstufe Fzg. mit 3,0 und 3,5 t zGG, Auflastung auf 3,8 t zGG möglich nicht für Radstand = 3250 mm	01/15-01/18	KIT		313 553 900 113		60	34.0	17.6	120	2800		im KIT enthalten 313 108 300 113		01/15-01/18 für Fzg. ohne Vorrüstung	S	CAN	C	E	D1	L1	V	90
Mercedes Sprinter Kasten/ Kombi 907+910 nicht für Fahrzeuge mit AWD und Zwillingsbereifung Fahrzeuge mit bis zu 3,5t inkl. Kugelplatte für Fahrzeuge ohne Trittstufe Wechselsystem zulässig	02/18-			313 641 600 001		60	21.7	20.2	150	3500		313 217 300 113		02/18- inkl. WLC 2.0	S	FRE	C	E	D	L1	V	75
		KIT		313 641 900 113		60	23.4	20.2	150	3500		im KIT enthalten 313 217 300 113		02/18- inkl. WLC 2.0	S	FRE	C	E	D	L1	V	75
Mercedes Sprinter Kasten/ Kombi 907+910 Fzg. mit 5,0 t zGG, Ablastung auf 4,6 t zGG möglich Radstand: 3665 mm bei Fzg. mit Stoßfänger mit integrierter Trittstufe muss das mittlere Teil der Außenhaut ausgetauscht werden (erhältlich beim Mercedes-Händler) passende Kugelplatte: 329141600001 Passende Trittstufe: 313285600001 / 313440600001	02/18-			313 272 600 001		120	22.0	20.2	150	3500		313 217 300 113		02/18- inkl. WLC 2.0	S	FRE	C	E	D	L1	V	75























Mercedes Sprinter Kasten/ Kombi 907+910 Fzg. mit 5,0 t zGG, Ablastung auf 4,6 t zGG möglich Radstand: 4325 mm bei Fzg. mit Stoßfänger mit integrierter Trittstufe muss das mittlere Teil der Außenhaut ausgetauscht werden (erhältlich beim Mercedes-Händler) passende Kugelplatte: 329141600001 Passende Trittstufe: 313285600001 / 313440600001	02/18-			313 273 600 001		120	23.0	20.2	150	3500		313 217 300 113		02/18- inkl. WLC 2.0	S	FRE	C	E	D	L1	V	75
Mercedes Sprinter Kasten/ Kombi W910 Frontantrieb mit Trittstufe	02/18-			313 680 600 001		30	29.0	12.5	150	2000		313 217 300 113		02/18- inkl. WLC 2.0	S	FRE	C	E	D	L1	V	75
Mercedes Sprinter Pritsche/ Fahrgestell für Fzg. ohne Vorrüstung Typen 411-424 und 509-524 Fzg. mit 5,0 t zGG, Ablastung auf 4,6 t zGG möglich Radstand: 3665 + 4325 mm inkl. Kugelplatte	04/06-12/14	KIT		313 275 900 113		90	20.0	20.2	150	3500		im KIT enthalten 313 105 300 113		-12/14 für Fzg. ohne Vorrüstung	S	CAN	C	E	D1	--	V	90
Mercedes Sprinter Pritsche/ Fahrgestell für Fzg. ohne Vorrüstung Typen 209-224 und 309-324 Fzg. mit 3,0 und 3,5 t zGG, Auflastung auf 3,8 t zGG möglich nicht für Fzg. mit Unterfahrschutz inkl. Kugelplatte	04/06-12/14	KIT		313 377 900 113		90	22.0	18.1	150	3500		im KIT enthalten 313 105 300 113		-12/14 für Fzg. ohne Vorrüstung	S	CAN	C	E	D1	--	V	90
Mercedes Sprinter Pritsche/ Fahrgestell für Fzg. ohne Vorrüstung - 3,8 t Typen 209-224 und 309-324 nicht für Fzg. mit Unterfahrschutz inkl. Kugelplatte	04/06-12/14	KIT		313 522 900 113		60	21.8	20.2	240	3500		im KIT enthalten 313 105 300 113		-12/14 für Fzg. ohne Vorrüstung	S	CAN	C	E	D1	--	V	90











Mercedes-Benz

Mercedes Sprinter Pritsche/ Fahrgestell Typen 411-424 und 509-524 Fzg. mit 5,0 t zGG, Ablastung auf 4,6 t zGG möglich Radstand: 3665 + 4325 mm passende Kugelplatte: 329059600001	04/06-01/18		313 275 600 001			90	18.0	20.2	150	3500				313 105 300 107 → -12/14 für Fzg. ohne Vorrüstung	S	CAN	C	E	--	--	V	90	
															313 105 300 113 -12/14 für Fzg. ohne Vorrüstung	S	CAN	C	E	D1	--	V	90
															313 107 300 113 01/15-01/18 für Fzg. mit Vorrüstung	S	CAN	C	E	D1	L1	H	45
															313 108 300 113 01/15-01/18 für Fzg. ohne Vorrüstung	S	CAN	C	E	D1	L1	V	90
															321 106 300 113 -12/14 für Fzg. mit Vorrüstung	S	CAN	C	E	D	--	H	45
Mercedes Sprinter Pritsche/ Fahrgestell Typen 209-224 und 309-324 Fzg. mit 3,0 und 3,5 t zGG, Auflastung auf 3,8 t zGG möglich nicht für Fzg. mit Unterfahrschutz passende Kugelplatte: 329059600001	04/06-01/18		313 377 600 001 →			90	20.0	18.1	150	3500			313 105 300 107 → -12/14 für Fzg. ohne Vorrüstung	S	CAN	C	E	--	--	V	90		
														313 105 300 113 -12/14 für Fzg. ohne Vorrüstung	S	CAN	C	E	D1	--	V	90	
														313 107 300 113 01/15-01/18 für Fzg. mit Vorrüstung	S	CAN	C	E	D1	L1	H	45	
														313 108 300 113 01/15-01/18 für Fzg. ohne Vorrüstung	S	CAN	C	E	D1	L1	V	90	
														321 106 300 113 -12/14 für Fzg. mit Vorrüstung	S	CAN	C	E	D	--	H	45	
Mercedes Sprinter Pritsche/ Fahrgestell - 3,8 t Typen 209-224 und 309-324 nicht für Fzg. mit Unterfahrschutz inkl. Kugelplatte (nur Verwendung 2-Loch-Flansch möglich)	04/06-01/18		313 522 600 001			60	19.6	20.2	240	3500			313 105 300 107 → -12/14 für Fzg. ohne Vorrüstung	S	CAN	C	E	--	--	V	90		
														313 105 300 113 -12/14 für Fzg. ohne Vorrüstung	S	CAN	C	E	D1	--	V	90	
														313 107 300 113 01/15-01/18 für Fzg. mit Vorrüstung	S	CAN	C	E	D1	L1	H	45	
														313 108 300 113 01/15-01/18 für Fzg. ohne Vorrüstung	S	CAN	C	E	D1	L1	V	90	
														321 106 300 113 -12/14 für Fzg. mit Vorrüstung	S	CAN	C	E	D	--	H	45	
Mercedes Sprinter Pritsche/ Fahrgestell für Fzg. ohne Vorrüstung - 3,8 t Typen 209-224 und 309-324 nicht für Fzg. mit Unterfahrschutz inkl. Kugelplatte 3290806000001	01/15-01/18	KIT 	313 107 900 113			60	22.9	20.2	240	3500			im KIT enthalten 313 108 300 113	01/15-01/18 für Fzg. ohne Vorrüstung	S	CAN	C	E	D1	L1	V	90	

























Mercedes Sprinter Pritsche/ Fahrgestell 907+910 inkl. Kugelplatte für Fahrzeuge ohne Trittstufe nicht für Fahrzeuge mit Unterfahrschutz unter der Hecktraverse (EG gemäß Datenkarte C71) nicht für Fahrzeuge mit 5,0t und 5,5t zGG Wechselsystem zulässig	02/18-			313 641 600 001			60	21.7	20.2	150	3500		313 217 300 113		02/18- 2.0	inkl. WLC	S	FRE	C	E	D	L1	V	75
		KIT		313 641 900 113			60	23.4	20.2	150	3500		im KIT enthalten 313 217 300 113		02/18- 2.0	inkl. WLC	S	FRE	C	E	D	L1	V	75
Mercedes T-Klasse W420 nicht für Fahrzeuge mit AHK- Vorbereitung nicht für Fahrzeuge mit Reserverrad	05/22-			316 492 600 001			90	26.7	9.4	114	1500		316 493 300 113				S	FRE	--	E	D1	L1	H	60
Mercedes T-Klasse W420 nicht für Fahrzeuge mit AHK- Vorbereitung nicht für Fahrzeuge mit Reserverrad	07/22-	KIT		316 492 900 113			90	28.3	9.4	114	1500		im KIT enthalten 316 493 300 113				S	FRE	--	E	D1	L1	H	60
Mercedes V-Klasse W447 auch für Allrad	04/14-			313 435 600 001			90	20.0	13.8	100	2500		313 436 300 113				S	CAN	C	E2	D	L1	V	90
				313 436 600 001			90	21.0	13.8	100	2500													
		KIT		313 435 900 113			90	22.0	13.8	100	2500		im KIT enthalten 313 436 300 113				S	CAN	C	E2	D	L1	V	90
		KIT		313 436 900 113			90	23.0	13.8	100	2500		im KIT enthalten 313 436 300 113				S	CAN	C	E2	D	L1	V	90
Mercedes Viano / V-Klasse ab Fg.-Nr. ...16793 auch für 4x4	02/04-04/14			313 240 600 001			120	19.0	13.8	150	2500		313 176 300 113				S	--	E1	D1	L1		75	
		KIT		313 240 900 113			120	20.5	13.8	150	2500		im KIT enthalten 313 176 300 113				S	--	E1	D1	L1		75	









Mercedes-Benz

















Mercedes Viano / V-Klasse ab Fg.-Nr. ...16793 auch für 4x4 Abdeckklappe für Stoßfängerausschnitt beim Mercedes-Händler beziehen.	02/04-04/14			313 382 600 001		90	20.0	13.5	150	2500		313 176 300 113			S	--	E1	D1	L1					75
		KIT		313 382 900 113		90	22.0	13.5	150	2500		im KIT enthalten 313 176 300 113			S	--	E1	D1	L1					75
Mercedes Vito ab Fg.-Nr. ...16793 auch für 4x4	02/04-08/14			313 240 600 001		120	19.0	13.8	150	2500		313 176 300 113			S	--	E1	D1	L1					75
		KIT		313 240 900 113		120	20.5	13.8	150	2500		im KIT enthalten 313 176 300 113			S	--	E1	D1	L1					75
Mercedes Vito ab Fg.-Nr. ...16793 auch für 4x4 Abdeckklappe für Stoßfängerausschnitt beim Mercedes-Händler beziehen.	02/04-08/14			313 382 600 001		90	20.0	13.5	150	2500		313 176 300 113			S	--	E1	D1	L1					75
		KIT		313 382 900 113		90	22.0	13.5	150	2500		im KIT enthalten 313 176 300 113			S	--	E1	D1	L1					75
Mercedes Vito W447 auch für Allrad auch für Tourer auch für eVito	09/14-			313 435 600 001		90	20.0	13.8	100	2500		313 436 300 113			S	CAN	C	E2	D	L1	V		90	
				313 436 600 001		90	21.0	13.8	100	2500														
Mercedes Vito W447 auch für Allrad auch für Tourer	09/14-	KIT		313 435 900 113		90	22.0	13.8	100	2500		im KIT enthalten 313 436 300 113			S	CAN	C	E2	D	L1	V		90	
		KIT		313 436 900 113		90	23.0	13.8	100	2500		im KIT enthalten 313 436 300 113			S	CAN	C	E2	D	L1	V		90	
Mercedes X-Klasse inkl. Kugelplatte	09/17-05/20			332 353 600 001		30	30.6	17.2	190	3500		332 354 300 113			S	FRE	--	E2	D1	L1	H		90	
		KIT		332 337 900 113		30	32.0	17.2	190	3500		im KIT enthalten 332 354 300 113			S	FRE	--	E2	D1	L1	H		90	

Mini R55 Clubman (Kombi) auch für Cooper S, Clubvan Bitte prüfen, ob Anhängelast in den Fahrzeugpapieren eingetragen ist.	09/10-06/14		323 100 600 001			40	20.5	6.0	50	1000																	
Mini R60 Countryman Nicht für Fahrzeuge mit werksseitiger Fahrradträger- Vorbereitung. Nicht für Cooper S/SD. Bitte prüfen, ob Anhängelast in den Fahrzeugpapieren eingetragen ist.	09/10-05/16		323 097 600 001			60	21.0	7.4	75	1200																	
Mini Cabrio ist vom Hersteller nicht für den Anhängerbetrieb freigegeben.																											
Mini Clubman Cooper S nicht für Fahrzeuge mit Fußsensor nicht für John Cooper Works & John Cooper Works Trim	11/15-		303 372 600 001			90	21.0	10.4	80	2000	303 372 300 113			S	CAN	--	E	D	L1	V	105						
			303 480 300 113			90	21.0	10.4	80	2000	303 480 300 113		11/15-	S	CAN	--	E	D	L1	V	105						
KIT			303 374 900 113			90	21.0	10.4	80	2000	im KIT enthalten 303 480 300 113		11/15-	S	CAN	--	E	D	L1	V	105						
Mini Coupé ist vom Hersteller nicht für den Anhängerbetrieb freigegeben.	09/11-																										

Mitsubishi





















Mitsubishi ASX I auch für ASX 2019-	06/10-12/22		340 092 600 001		90	22.0	8.5	70	1400	340 093 300 113			S	A	--	--	D	L	H	60
			340 093 600 001		90	24.0	8.5	70	1400											
	KIT		340 092 900 113		90	24.0	8.5	70	1400	im KIT enthalten 340 093 300 113			S	A	--	--	D	L	H	60
			340 093 900 113		90	26.0	8.5	70	1400	im KIT enthalten 340 093 300 113										
Mitsubishi Eclipse Cross nicht für AdBlue nicht für Plugin Hybrid	10/17-		340 131 600 001		45	24.7	9.0	80	1600	340 099 300 113		nicht für Plugin Hybrid	S	A	--	E2	D	L	V	75
			340 132 600 001		45	26.0	9.0	80	1600											
	KIT		340 131 900 113		45	25.9	9.0	80	1600	im KIT enthalten 340 099 300 113		nicht für Plugin Hybrid	S	A	--	E2	D	L	V	75
			340 132 900 113		45	27.2	9.0	80	1600	im KIT enthalten 340 099 300 113										
Mitsubishi L200 Club-Cab, Single-Cab Double-Cab -07/09 nicht für Double-Cab 08/09- inkl. Kugelplatte	01/06-07/15		340 089 600 001	→	90	35.0	14.7	120	3000	300 052 300 113			--	FRE	--	E1	D1	--	V	
Mitsubishi L200 Double Cab inkl. Kugelplatte nicht für AdBlue	07/15-08/19		340 124 600 001		60	31.5	14.7	125	3100	340 136 300 107	→		S	C2	--	--	--	--	V	90
Mitsubishi L200 V Facelift inkl. Kugelplatte	09/19-		340 143 600 001		60	29.1	16.2	140	3500	340 144 300 113			S	CAN	--	E2	D	L	V	75
Mitsubishi Outlander	04/07-09/12		340 094 600 001		90	27.0	10.9	100	2000	340 075 300 113			S	FRE	--	E	D	L	H	75
		KIT		340 094 900 113		90	29.0	10.9	100	2000	im KIT enthalten 340 075 300 113			S	FRE	--	E	D	L	H























Mitsubishi Outlander nicht für PHEV Hybrid	09/12-03/22		340 098 600 001		90	25.0	11.0	100	2000		340 099 300 113	für Modell PHEV = 300210300113	S	A	--	E2	D	L	V	75
		KIT		340 098 900 113		90	27.0	11.0	100	2000		im KIT enthalten 340 099 300 113	für Modell PHEV = 300210300113	S	A	--	E2	D	L	V
Mitsubishi Outlander	09/12-03/22		340 099 600 001		90	25.0	11.0	100	2000		340 099 300 113	für Modell PHEV = 300210300113	S	A	--	E2	D	L	V	75
		KIT		340 099 900 113		90	27.0	11.0	100	2000		im KIT enthalten 340 099 300 113	für Modell PHEV = 300210300113	S	A	--	E2	D	L	V

Nissan Interstar Kasten/Kombi X62B Frontantrieb inkl. Kugelplatte	11/21-		316 318 600 001			60	19.3	14.3	100	2500		316 300 300 113		11/21- für Fzg. ohne Zentralsteckver- bindung	S	FRE	--	E2	D1	L1	H	45
Nissan Interstar Kasten/Kombi X62B Frontantrieb inkl. Kugelplatte für Fzg. ohne Zentralsteckverbindung	11/21-	KIT 	316 318 900 113			60	21.0	14.3	100	2500		im KIT enthalten 316 300 300 113		11/21- für Fzg. ohne Zentralsteckver- bindung	S	FRE	--	E2	D1	L1	H	45
Nissan Interstar Pritsche X62B Front- + Heckantrieb inkl. Kugelplatte nicht für Fzg. mit Doppelbereifung	11/21-		316 347 600 001			60	16.5	13.7	85	2300												
Nissan Juke 2 WD nicht für Nismo	10/10-07/19		332 304 600 001			60	25.0	8.5	75	1500		332 305 300 113		-07/19	S	A	--	E1	D1	L1	V	60
		KIT 	332 304 900 113			60	27.0	8.5	75	1500		im KIT enthalten 332 305 300 113		-07/19	S	A	--	E1	D1	L1	V	60
Nissan Juke (F16)	08/19-		332 367 600 001			60		7.5	85	1350		316 482 300 113			S	A	C1	E2	D	L1	V	60
		KIT 	332 367 900 113			60		7.5	85	1350		im KIT enthalten 316 482 300 113			S	A	C1	E2	D	L1	V	60
Nissan Kubistar	01/02-12/09		316 201 600 001			60	12.0	7.6	75	1320		316 205 300 113		nur für Fzg. mit akustischem Signalgeber	S	A	--	--	D1	--	H	45
		KIT 	316 201 900 113			60	14.0	7.6	75	1320		im KIT enthalten 316 205 300 113		nur für Fzg. mit akustischem Signalgeber	S	A	--	--	D1	--	H	45
Nissan Kubistar 4x4	01/02-12/09		316 205 600 001			60	12.0	7.6	75	1320		316 205 300 113		nur für Fzg. mit akustischem Signalgeber	S	A	--	--	D1	--	H	45
Nissan NV 400 Kasten/Kombi X62 Frontantrieb inkl. Kugelplatte	03/10-10/21		316 318 600 001			60	19.3	14.3	100	2500		316 300 300 107		für Fzg. ohne Zentralsteckver- bindung	S	FRE	--	E2	--	--	H	45
												316 300 300 113		für Fzg. ohne Zentralsteckver- bindung	S	FRE	--	E2	D1	L1	H	45
												316 318 300 113		für Fzg. mit Zentralsteck- verbindung	S	FRE	--	E2	D1	L1	H	15

Nissan







Nissan













Nissan NV 400 Kasten/Kombi X62 Frontantrieb inkl. Kugelplatte für Fzg. ohne Zentralsteckverbindung	03/10-10/21	KIT		316 318 900 113			60	21.0	14.3	100	2500			im KIT enthalten 316 300 300 113		für Fzg. ohne Zentralsteckver- bindung	S	FRE	--	E2	D1	L1	H	45
Nissan NV 400 Pritsche X62 Front- + Heckantrieb inkl. Kugelplatte nicht für Fzg. mit Doppelbereifung	07/10-10/21			316 347 600 001			60	16.5	13.7	85	2300			300 201 300 113 316 319 300 113			--	A	--	E1	D1	--	V	
Nissan Navara D23 inkl. Kugelplatte	11/15-			332 353 600 001			30	30.6	17.2	190	3500			332 354 300 113		11/15-	S	FRE	--	E2	D1	L1	H	90
		KIT		332 337 900 113			30	32.0	17.2	190	3500			im KIT enthalten 332 354 300 113		11/15-	S	FRE	--	E2	D1	L1	H	90
Nissan Navara D40 inkl. Kugelplatte	10/04-10/15			332 353 600 001			30	30.6	17.2	190	3500			300 052 300 113		10/04-10/15	--	FRE	--	E1	D1	--	V	
Nissan Primastar X83 inkl. Kugelplatte	07/01-01/16			314 364 600 001	→		60	21.0	12.3	85	2100			314 860 300 113 314 870 300 113		08/06-03/10 03/10-	S	FRE	--	--	D1	L1	H	60
		KIT		314 364 900 113			60	23.0	12.3	85	2100			im KIT enthalten 314 860 300 113		08/06-03/10	S	FRE	--	--	D1	L1	H	60
Nissan Primastar X83 inkl. Kugelplatte	03/10-09/14	KIT		314 870 900 113			60	23.0	12.3	85	2100			im KIT enthalten 314 870 300 113		03/10-	S	FRE	--	--	D1	L1	H	60
Nissan Pulsar nicht für AdBlue-Modelle	09/14-06/18			332 329 600 001			60	22.5	7.4	75	1200													
Nissan Qashqai III J12	04/21-			332 368 600 001			90	20.7	11.5	100	2100			332 369 300 113		04/21-	S	FRE	--	E2	D1	L1	H	45
				332 369 600 001			90	21.0	11.5	100	2100													
		KIT		332 368 900 113			90	22.7	11.5	100	2100			im KIT enthalten 332 369 300 113		04/21-	S	FRE	--	E2	D1	L1	H	45
		KIT		332 369 900 113			90	23.0	11.5	100	2100			im KIT enthalten 332 369 300 113		04/21-	S	FRE	--	E2	D1	L1	H	45

Nissan Qashqai, Qashqai +2 nicht für AdBlue-Modelle	02/07-01/14	KIT		332 246 900 113		120	24.0	9.4	100	1800		im KIT enthalten 332 262 300 113	-01/14	S	A	--	--	D1	L1	V	75
		KIT		332 247 900 113		120	27.0	9.4	100	1800		im KIT enthalten 332 262 300 113	-01/14	S	A	--	--	D1	L1	V	75
Nissan Qashqai, Qashqai +2 nicht für AdBlue-Modelle inkl. Kugelplatte	02/07-12/17			332 266 600 001	→ 	120	22.6	8.6	70	1400		332 262 300 113	-01/14	S	A	--	--	D1	L1	V	75
												332 327 300 107	02/14-07/19 für Fg.-Nr. bis U2622270	S	FRE	--	E2	--	--	H	60
													332 327 300 113	02/14-07/19 für Fg.-Nr. bis U2622270	S	FRE	--	E2	D	L1	H
Nissan Qashqai, Qashqai +2 nicht für AdBlue-Modelle	02/07-12/17			332 319 600 001		120	22.0	9.4	100	1800		332 262 300 113	-01/14	S	A	--	--	D1	L1	V	75
				332 327 600 001		120	25.0	9.4	100	1800		332 327 300 107	02/14-07/19 für Fg.-Nr. bis U2622270	S	FRE	--	E2	--	--	H	60
												332 327 300 113	02/14-07/19 für Fg.-Nr. bis U2622270	S	FRE	--	E2	D	L1	H	60
Nissan Qashqai, Qashqai +2 nicht für AdBlue-Modelle	02/14-12/17	KIT		332 326 900 113		120	24.0	9.4	100	1800		im KIT enthalten 332 327 300 113	02/14-07/19 für Fg.-Nr. bis U2622270	S	FRE	--	E2	D	L1	H	60
		KIT		332 327 900 113		120	27.0	9.4	100	1800		im KIT enthalten 332 327 300 113	02/14-07/19 für Fg.-Nr. bis U2622270	S	FRE	--	E2	D	L1	H	60
Nissan Qashqai, Qashqai +2 J11	01/18-07/19	KIT		332 360 900 113		75	27.6	10.1	100	1800		im KIT enthalten 332 327 300 113	02/14-07/19 für Fg.-Nr. bis U2622270	S	FRE	--	E2	D	L1	H	60
Nissan Qashqai, Qashqai +2 J11	01/18-04/21			332 359 600 001		75	24.1	10.1	100	1800		332 327 300 107	02/14-07/19 für Fg.-Nr. bis U2622270	S	FRE	--	E2	--	--	H	60
				332 360 600 001		75	25.2	10.1	100	1800		332 327 300 113	02/14-07/19 für Fg.-Nr. bis U2622270	S	FRE	--	E2	D	L1	H	60
												332 367 300 113	08/19-04/21 für Fzg. mit Vorrüstung	S	A	C1	E2	D	L1	V	75
Nissan Townstar XFK für Fzg. ohne Reserverad	12/21-			316 492 600 001		90	26.7	9.4	114	1500		316 493 300 113									60





























Nissan

Nissan

Nissan Townstar XFK für Fzg. ohne AHK-Vorbereitung für Fzg. ohne Reserverad	12/21-	KIT 	316 492 900 113			90	28.3	9.4	114	1500		im KIT enthalten 316 493 300 113									60	
Nissan X-Trail III T32 auch für AdBlue	07/14-09/22		332 323 600 001			90	27.0	10.9	80	2000		332 327 300 107 332 327 300 113			S	FRE	--	E2	--	--	H	60
		KIT 	332 323 900 113			90	29.0	10.9	80	2000		im KIT enthalten 332 327 300 113			S	FRE	--	E2	D	L1	H	60



















Opel Antara nicht für Kfz. mit Fahrradträgersystem Flex-Fix nicht für Kfz. mit Niveauregulierung	02/07-02/15		314 304 600 001			150	24.0	12.3	150	2500		314 422 300 113	05/11- Fg.-Nr. H5BB034034 -	S	A	--	E2	D	L1	V	90
												342 027 300 113 →		für Fzg. mit Vorrüstung	S	FRE	--	E1	D	L1	H
Opel Antara nicht für Kfz. mit Fahrradträgersystem Flex-Fix nicht für Kfz. mit Niveauregulierung	05/11-02/15	KIT 	314 421 900 113			150	26.0	12.3	150	2500		im KIT enthalten 314 422 300 113	05/11- Fg.-Nr. H5BB034034 -	S	A	--	E2	D	L1	V	90
Opel Astra Coupé	00-03/04		314 236 600 001	→		>150	23.1	8.6	75	1500		300 072 300 107		--	FRE	--	--	--	--	V	
												300 210 300 113		--	A	--	E1	D1	L1	V	90
Opel Astra G Fließ-/Stufenheck	03/98-03/04		314 236 600 001	→		>150	23.1	8.6	75	1500		300 072 300 107		--	FRE	--	--	--	--	V	
												300 210 300 113		--	A	--	E1	D1	L1	V	90
Opel Astra H Caravan Um den optimalen Sitz des Stoßfängers zu gewährleisten, empfehlen wir die Montage der Auflagen Opel-Nr. 1313 8158 bzw. 1316 8808.	10/04-11/10		314 496 600 001			60	17.0	9.1	75	1650		300 210 300 113	für Kfz. ohne Zentralelektrik hinten (REC)	--	A	--	E1	D1	L1	V	90
				314 500 600 001			60	18.5	9.1	75	1600		314 300 300 113	für Kfz. mit Zentralelektrik hinten (REC)	S	FRE	C	E	D	L1	H
		KIT 	314 285 900 113			60	19.0	9.1	75	1650		im KIT enthalten 314 300 300 113	für Kfz. mit Zentralelektrik hinten (REC)	S	FRE	C	E	D	L1	H	45
		KIT 	314 287 900 113			60	19.5	9.1	75	1650		im KIT enthalten 314 300 300 113	für Kfz. mit Zentralelektrik hinten (REC)	S	FRE	C	E	D	L1	H	45
Opel Astra H Fließheck auch für GTC nicht für OPC / 240 PS	03/04-12/09		314 299 600 001			60	21.5	9.0	75	1650		300 210 300 113	für Kfz. ohne Zentralelektrik hinten (REC)	--	A	--	E1	D1	L1	V	90
				314 281 600 001			60	21.5	9.0	75	1650		314 300 300 113	für Kfz. mit Zentralelektrik hinten (REC)	S	FRE	C	E	D	L1	H
		KIT 	314 299 900 113			60	23.5	9.0	75	1650		im KIT enthalten 314 300 300 113	für Kfz. mit Zentralelektrik hinten (REC)	S	FRE	C	E	D	L1	H	45
		KIT 	314 281 900 113			60	23.5	9.0	75	1650		im KIT enthalten 314 300 300 113	für Kfz. mit Zentralelektrik hinten (REC)	S	FRE	C	E	D	L1	H	45





























Opel

Opel Astra J Fließheck nicht für Kfz. mit Fahrradträgersystem Flex-Fix	12/09-09/15		314 474 600 001		60	23.0	9.6	75	1800											S	CAN	--	E	D	L1	V	90	
			314 473 600 001		60	23.0	9.6	75	1800																			
	KIT		314 474 900 113		60	25.0	9.6	75	1800												S	CAN	--	E	D	L1	V	90
	KIT		314 473 900 113		60	25.0	9.6	75	1800												S	CAN	--	E	D	L1	V	90
Opel Astra J Sports Tourer nicht für Kfz. mit Fahrradträgersystem Flex-Fix Bitte Klappe für Stoßängerauschnitt beim Opel- Händler bestellen.	11/10-01/16		314 406 600 001		60	25.0	9.6	75	1800											S	CAN	--	E	D	L1	V	90	
		KIT		314 406 900 113		60	31.0	9.6	75	1800											S	CAN	--	E	D	L1	V	90
Opel Astra J Sports Tourer nicht für Kfz. mit Fahrradträgersystem Flex-Fix	11/10-01/16		314 407 600 001		60	24.5	9.6	75	1800											S	CAN	--	E	D	L1	V	90	
		KIT		314 407 900 113		60	26.5	9.6	75	1800											S	CAN	--	E	D	L1	V	90
Opel Astra K Fließheck 5-Türer nicht für Fzg. mit CVT-Getriebe	09/15-12/21		314 513 600 001		60	21.0	9.9	75	1700											S	CAN	--	E2	D	L1	V	90	
		KIT		314 513 900 113		60	24.0	9.9	75	1700											S	CAN	--	E2	D	L1	V	90
Opel Astra K SW / Sports Tourer nicht für Fzg. mit CVT-Getriebe Spoiler inkl. Abdeckklappe bitte beim Opel-Händler bestellen. Um den optimalen Sitz des Stoßfängers zu gewährleisten, empfehlen wir die Montage eines Styroporträgers (beim Opel- Händler erhältlich).	03/16-12/21		314 516 600 001		60	19.5	9.9	75	1700											S	CAN	--	E2	D	L1	V	90	
			314 515 600 001		60	20.0	9.9	75	1700																			
		KIT		314 516 900 113		60	23.0	9.9	75	1700											S	CAN	--	E2	D	L1	V	90
		KIT		314 515 900 113		60	24.5	9.9	75	1700											S	CAN	--	E2	D	L1	V	90



























Opel Astra L 5-Türer O5 auch für Plugin-Hybrid	10/21-			314 603 600 001		90	21.7	9.2	90	1650		314 602 300 113	10/21- auch für Plug-in Hybrid	S	CAN	C	E	D	L1	H	75
		KIT		314 603 900 113		90	24.2	9.2	90	1650		im KIT enthalten 314 602 300 113	10/21- auch für Plug-in Hybrid	S	CAN	C	E	D	L1	H	75
Opel Astra L Sports Tourer O5 auch für Plugin-Hybrid	10/21-			314 604 600 001		90	20.0	9.2	108	1650		314 602 300 113	10/21- auch für Plug-in Hybrid	S	CAN	C	E	D	L1	H	75
				314 605 600 001		90	22.0	9.2	112	1650											
		KIT		314 604 900 113		90	22.0	9.2	108	1650		im KIT enthalten 314 602 300 113	10/21- auch für Plug-in Hybrid	S	CAN	C	E	D	L1	H	75
		KIT		314 605 900 113		90	24.0	9.2	108	1650		im KIT enthalten 314 602 300 113	10/21- auch für Plug-in Hybrid	S	CAN	C	E	D	L1	H	75
Opel Combo nicht für Kfz. mit Gasbetrieb (CNG) nicht für Kfz. mit Einparkhilfe	02/12-08/18			306 368 600 001		60	23.0	9.2	100	1500		306 605 300 113		S	FRE	--	E	D1	L1	V	90
		KIT		306 368 900 113		45	25.0	9.2	100	1500		im KIT enthalten 306 605 300 113		S	FRE	--	E	D1	L1	V	90
Opel Combo nicht für Kfz. mit Gasbetrieb (CNG)	02/12-08/18			306 369 600 001		60	25.0	9.2	100	1500		306 605 300 113		S	FRE	--	E	D1	L1	V	90
		KIT		306 369 900 113		60	27.0	9.2	100	1500		im KIT enthalten 306 605 300 113		S	FRE	--	E	D1	L1	V	90
Opel Combo inkl. Kugelplatte für Kfz. mit Gasbetrieb (CNG)	02/12-08/18			306 382 600 001		60	25.0	7.0	75	1000		306 605 300 113		S	FRE	--	E	D1	L1	V	90
		KIT		306 382 900 113		60	27.0	7.0	75	1000		im KIT enthalten 306 605 300 113		S	FRE	--	E	D1	L1	V	90





























Opel

Opel Combo L1 Cargo + Life	09/18-		304 207 600 001			60	20.0	8.6	75	1500		314 594 300 113	inkl. WLC 2.0	S	A	C	E	D	L	V	90	
			304 209 600 001			60	20.5	8.6	75	1500												
	KIT		304 207 900 113			60	21.2	8.6	75	1500		im KIT enthalten 314 594 300 113	inkl. WLC 2.0	S	A	C	E	D	L	V	90	
	KIT		304 209 900 113			60	21.8	8.6	75	1500		im KIT enthalten 314 594 300 113	inkl. WLC 2.0	S	A	C	E	D	L	V	90	
Opel Combo L2 Cargo + Life	09/18-		304 210 600 001			60	21.0	8.6	75	1500		314 594 300 113	inkl. WLC 2.0	S	A	C	E	D	L	V	90	
			304 212 600 001			60	21.5	8.6	75	1500												
	KIT		304 210 900 113			60	22.2	8.6	75	1500		im KIT enthalten 314 594 300 113	inkl. WLC 2.0	S	A	C	E	D	L	V	90	
	KIT		304 212 900 113			60	22.8	8.6	75	1500		im KIT enthalten 314 594 300 113	inkl. WLC 2.0	S	A	C	E	D	L	V	90	
Opel Combo L1 Cargo + Life inkl. Kugelplatte	09/18-		304 118 600 001			90	17.0	8.4	64	1600		314 594 300 113	inkl. WLC 2.0	S	A	C	E	D	L	V	90	
Opel Corsa Combo Van nicht für Kfz. mit Gasbetrieb (CNG)	03/02-12/12		314 282 600 001			150	16.4	7.5	75	1200		300 072 300 107		--	FRE	--	--	--	--	--	V	
Opel Corsa D nicht für Kfz. mit Fahrradträgersystem Flex-Fix nicht für OPC, nicht für OPC-Line, nicht für Gsi	10/06-12/14		314 306 600 001			60	17.0	7.7	55	1200		314 307 300 113		S	A	--	--	D1	--	V	90	
			314 436 600 001			60	18.5	7.7	55	1200												
	KIT		314 306 900 113			60	19.0	7.7	55	1200		im KIT enthalten 314 307 300 113		S	A	--	--	D1	--	V	90	
	KIT		314 307 900 113			60	20.5	7.7	55	1200		im KIT enthalten 314 307 300 113		S	A	--	--	D1	--	V	90	















Opel Corsa E nicht für Kfz. mit Fahrradträgersystem Flex-Fix nicht für OPC, nicht für OPC-Line, nicht für Gsi	01/15-06/19			314 306 600 001		60	17.0	7.7	55	1200		314 436 300 113	-06/19	S	CAN	--	E	D	L1	V	90	
				314 436 600 001		60	18.5	7.7	55	1200												
	KIT		314 435 900 113		60	19.0	7.7	55	1200		im KIT enthalten 314 436 300 113	-06/19	S	CAN	--	E	D	L1	V	90		
	KIT		314 436 900 113		60	20.5	7.7	55	1200		im KIT enthalten 314 436 300 113	-06/19	S	CAN	--	E	D	L1	V	90		
Opel Corsa F nicht für Corsa-e	06/19-			314 597 600 001		75	25.0	7.2	83	1200		314 596 300 113	für Fzg. ohne Vorrüstung, nicht für Corsa-e	S	CAN	C	E2	D1	L1	V	75	
Opel Corsa F für Fzg. ohne Vorrüstung nicht für Corsa-e	06/19-	KIT		314 597 900 113		75	26.8	7.2	83	1200		im KIT enthalten 314 596 300 113	für Fzg. ohne Vorrüstung, nicht für Corsa-e	S	CAN	C	E2	D1	L1	V	75	
Opel Crossland X auch für Facelift 2021-	03/17-			314 583 600 001		60	23.0	6.4	78	1000		314 580 300 113	inkl. WLC 2.0	S	CAN	C	E2	D1	L1	V	90	
				314 584 600 001		60	24.5	6.4	78	1000												
	KIT		314 583 900 113		60	24.0	6.4	78	1000		im KIT enthalten 314 580 300 113	inkl. WLC 2.0	S	CAN	C	E2	D1	L1	V	90		
	KIT		314 584 900 113		60	25.5	6.4	78	1000		im KIT enthalten 314 580 300 113	inkl. WLC 2.0	S	CAN	C	E2	D1	L1	V	90		
Opel Grandland X nicht für Hybrid 4	07/17-			315 243 600 001		120	22.0	10.0	80	2000		314 595 300 113	inkl. WLC 2.0	S	CAN	C	E2	D1	L1	V	75	
				315 244 600 001		120	24.0	10.0	80	2000												
	KIT		314 590 900 113		120	23.1	10.0	80	2000		im KIT enthalten 314 595 300 113	inkl. WLC 2.0	S	CAN	C	E2	D1	L1	V	75		
	KIT		314 591 900 113		120	26.1	10.0	80	2000		im KIT enthalten 314 595 300 113	inkl. WLC 2.0	S	CAN	C	E2	D1	L1	V	75		























Opel

Opel Grandland X Hybrid A18 nur für Plugin-Hybrid	06/19-		314 599 600 001		90	26.7	8.1	95	1270		314 595 300 113			S	CAN	C	E2	D1	L1	V	75	
Opel Insignia B Grand Sport nicht für GSI nicht für OPC auch für AdBlue	03/17-12/22		314 581 600 001		60	25.6	11.0	134	2200		314 386 300 113			S	CAN	--	E	D	L1	V	90	
			314 582 600 001		60	26.4	11.0	134	2200					S	CAN	--	E	D	L1	V	90	
		KIT		314 581 900 113		60	27.0	11.0	134	2200		im KIT enthalten 314 386 300 113			S	CAN	--	E	D	L1	V	90
		KIT		314 582 900 113		60	27.7	11.0	134	2200		im KIT enthalten 314 386 300 113			S	CAN	--	E	D	L1	V	90
Opel Insignia B Sports Tourer nicht für GSI nicht für Country Tourer auch für AdBlue Bei Fzg. mit automatischer Heckklappenöffnung muss der Sensor versetzt werden. auch für Facelift 2020-	06/17-12/22		314 587 600 001		60	26.6	11.0	134	2200		314 386 300 113	06/17-		S	CAN	--	E	D	L1	V	90	
			314 588 600 001		60	27.8	11.0	134	2200					S	CAN	--	E	D	L1	V	90	
		KIT		314 587 900 113		60	27.8	11.0	134	2200		im KIT enthalten 314 386 300 113	06/17-		S	CAN	--	E	D	L1	V	90
		KIT		314 588 900 113		60	29.0	11.0	134	2200		im KIT enthalten 314 386 300 113	06/17-		S	CAN	--	E	D	L1	V	90
Opel Insignia Limousine nicht für OPC, auch für 4x4	11/08-05/17		314 341 600 001		90	24.0	11.3	85	2100		314 386 300 113			S	CAN	--	E	D	L1	V	90	
		KIT		314 341 900 113		90	25.5	11.6	85	2100					im KIT enthalten 314 386 300 113			S	CAN	--	E	D
Opel Insignia Sports Tourer 2 WD, Frontantrieb nicht für OPC	03/09-05/17		314 390 600 001		90	23.0	11.3	85	2100		314 342 300 113	08/09-05/17		S	CAN	--	E2	D1	L1	H	45	
			314 342 600 001		90	26.5	11.3	85	2100					S	CAN	--	E2	D1	L1	H	45	















Opel Insignia Sports Tourer 2 WD, Frontantrieb nicht für OPC	08/09-05/17	KIT		314 390 900 113		90	27.9	11.3	85	2100		im KIT enthalten 314 342 300 113	08/09-05/17	S	CAN	--	E2	D1	L1	H	45
		KIT		314 342 900 113		90	28.0	11.3	85	2100		im KIT enthalten 314 342 300 113	08/09-05/17	S	CAN	--	E2	D1	L1	H	45
Opel Meriva nicht für OPC Wärmeschutzbleche erforderlich (siehe Betriebsanleitung des Fahrzeugs)	05/03-05/10			314 289 600 001		60	23.0	8.3	60	1300		314 289 300 113		S	FRE	--	E1	D1	--	H	60
		KIT		314 289 900 113		60	24.0	8.3	60	1300		im KIT enthalten 314 289 300 113		S	FRE	--	E1	D1	--	H	60
Opel Meriva nicht für Kfz. mit Fahrradträgersystem Flex-Fix Bitte prüfen, ob Anhängelast in den Fahrzeugpapieren eingetragen ist.	06/10-03/17			314 394 600 001		60	19.0	8.3	75	1300		314 386 300 113		S	CAN	--	E	D	L1	V	90
				314 392 600 001		60	20.0	8.3	75	1300					S	CAN	--	E	D	L1	V
		KIT		314 394 900 113		60	21.0	8.3	75	1300		im KIT enthalten 314 386 300 113		S	CAN	--	E	D	L1	V	90
		KIT		314 392 900 113		60	22.0	8.3	75	1300		im KIT enthalten 314 386 300 113		S	CAN	--	E	D	L1	V	90
Opel Mokka nicht für Kfz. mit Fahrradträgersystem Flex-Fix nicht für Kfz. mit Niveauregulierung nicht für OPC	10/12-08/16	KIT		314 450 900 113		60	23.0	8.6	75	1400		im KIT enthalten 314 451 300 113	-08/16	S	A	--	E2	D	L1	V	90
		KIT		314 451 900 113		60	25.0	8.6	75	1400		im KIT enthalten 314 451 300 113	-08/16	S	A	--	E2	D	L1	V	90
Opel Mokka nicht für Kfz. mit Fahrradträgersystem Flex-Fix nicht für Kfz. mit Niveauregulierung nicht für OPC	10/12-10/20			314 511 600 001		60	21.5	8.6	75	1400		314 451 300 113	-08/16	S	A	--	E2	D	L1	V	90
				314 510 600 001		60	21.0	8.6	75	1400											
Opel Mokka (B)	10/20-			314 601 600 001	→ 	60	25.8	7.2	83	1200		314 580 300 113		S	CAN	C	E2	D1	L1	V	90
		KIT		314 601 900 113		60	27.4	7.2	83	1200		im KIT enthalten 314 580 300 113		S	CAN	C	E2	D1	L1	V	90

















Opel

Opel Mokka (B) Bitte prüfen, ob Anhängelast in den Fahrzeugpapieren eingetragen ist. nicht für Mokka E	10/20-		304 216 600 001		90	25.0	7.1	61	1200													
Opel Mokka X	09/16-10/20		314 511 600 001		60	21.5	8.6	75	1400		314 386 300 113		S	CAN	--	E	D	L1	V	90		
				314 510 600 001		60	21.0	8.6	75	1400												
		KIT		314 511 900 113		60	25.0	8.6	75	1400	im KIT enthalten	314 386 300 113		S	CAN	--	E	D	L1	V	90	
		KIT		314 510 900 113		60	25.5	8.6	75	1400	im KIT enthalten	314 386 300 113		S	CAN	--	E	D	L1	V	90	
Opel Movano B Kasten/Kombi X62B Frontantrieb inkl. Kugelplatte	03/10-10/21		316 318 600 001		60	19.3	14.3	100	2500		316 300 300 107	03/10-10/21 für Fzg. ohne Zentralsteckverbindung	S	FRE	--	E2	--	--	H	45		
											316 300 300 113	03/10-10/21 für Fzg. ohne Zentralsteckverbindung	S	FRE	--	E2	D1	L1	H	45		
											316 318 300 113	03/10-10/21 für Fzg. mit Zentralsteckverbindung	S	FRE	--	E2	D1	L1	H	15		
Opel Movano B Kasten/Kombi X62B Frontantrieb inkl. Kugelplatte für Fzg. ohne Zentralsteckverbindung	03/10-10/21	KIT		316 318 900 113		60	21.0	14.3	100	2500	im KIT enthalten	316 300 300 113	03/10-10/21 für Fzg. ohne Zentralsteckverbindung	S	FRE	--	E2	D1	L1	H	45	
Opel Movano B Pritsche Front- + Heckantrieb inkl. Kugelplatte nicht für Fzg. mit Doppelbereifung	07/10-10/21		316 347 600 001		60	16.5	13.7	85	2300		316 319 300 113	07/10-10/21	S	FRE	--	E1	D1	--	H	15		
Opel Movano C Kasten/Kombi U9 inkl. Kugelplatte Bei Kfz. mit langem Überhang L4/XL bitte einen Satz Distanzröhrchen zur Rahmenverstärkung mitbestellen, Art.-Nr. 906270650003.	10/21-		306 490 600 001		120	32.0	16.9	150	3000		306 553 300 113	10/21-	S	FRE	--	E	D1	L1	V	105		























Opel Movano C Kasten/Kombi U9 Bei Kfz. mit langem Überhang L4/XL bitte einen Satz Distanzröhrchen zur Rahmenverstärkung mitbestellen, Art.-Nr. 906270650003.	10/21-			306 491 600 001			120	32.0	16.9	150	3000		306 553 300 113	10/21-	S	FRE	--	E	D1	L1	V	105
		KIT		306 491 900 113			120	32.8	16.9	150	3000		im KIT enthalten 306 553 300 113	10/21-	S	FRE	--	E	D1	L1	V	105
Opel Movano C Kasten/Kombi U9 inkl. Kugelplatte	10/21-			306 357 600 001			60	29.0	15.8	150	3000		306 553 300 113	10/21-	S	FRE	--	E	D1	L1	V	105
		KIT		306 553 900 113			>150	31.0	15.8	150	3000		im KIT enthalten 306 553 300 113	10/21-	S	FRE	--	E	D1	L1	V	105
Opel Movano C Kasten/Kombi U9 inkl. Kugelplatte Bei Kfz. mit langem Überhang L4/XL bitte einen Satz Distanzröhrchen zur Rahmenverstärkung mitbestellen, Art.-Nr. 906270650003.	10/21-	KIT		306 490 900 113			120	32.2	16.9	150	3000		im KIT enthalten 306 553 300 113	10/21-	S	FRE	--	E	D1	L1	V	105
Opel Movano C Kasten/Kombi U9 inkl. Kugelplatte für Fahrzeuge bis 6 m Länge 51 mm Vierkantaufnahme	10/21-			306 563 600 001			60	25.7	15.1	100	2500		306 553 300 113	10/21-	S	FRE	--	E	D1	L1	V	105
Opel Movano C Pritsche U9 inkl. Kugelplatte Bei Kfz. mit langem Überhang L4/XL bitte einen Satz Distanzröhrchen zur Rahmenverstärkung mitbestellen, Art.-Nr. 906270650003.	10/21-			306 492 600 001			120	35.0	15.9	150	3000		306 531 300 113	10/21-	S	FRE	--	E1	D	--	V	90
Opel Movano C Pritsche U9 inkl. Kugelplatte	10/21-			306 357 600 001			60	29.0	15.8	150	3000		306 531 300 113	10/21-	S	FRE	--	E1	D	--	V	90
Opel Movano C Pritsche U9 inkl. Kugelplatte Bei Kfz. mit langem Überhang L4/XL bitte einen Satz Distanzröhrchen zur Rahmenverstärkung mitbestellen, Art.-Nr. 906270650003.	10/21-	KIT		306 318 900 113			120	37.0	15.9	150	3000		im KIT enthalten 306 531 300 113	10/21-	S	FRE	--	E1	D	--	V	90
Opel Vectra C Caravan	10/03-02/09			314 501 600 001			60	33.5	10.7	85	2000											





















Opel

Opel Vivaro C Kasten/Kombi auch für Vivaro-e	03/19-			335 106 600 001			60	25.5	13.9	104	2500		314 585 300 113		inkl. WLC 2.0 für Fzg. mit Vorrüstung auch für Vivaro-e	S	FRE	C	E	D	L1	H	75
Opel Vivaro C Kasten/Kombi auch für Vivaro-e inkl. Kugelplatte	03/19-			304 190 600 001			45	26.0	13.9	104	2500		314 585 300 113		inkl. WLC 2.0 für Fzg. mit Vorrüstung auch für Vivaro-e	S	FRE	C	E	D	L1	H	75
Opel Vivaro C Kasten/Kombi auch für Vivaro-e für Fzg. mit Vorrüstung inkl. Kugelplatte	03/19-	KIT		314 576 900 113			45	27.7	13.9	104	2500		im KIT enthalten 314 585 300 113		inkl. WLC 2.0 für Fzg. mit Vorrüstung auch für Vivaro-e	S	FRE	C	E	D	L1	H	75
Opel Vivaro C Kasten/Kombi auch für Vivaro-e für Fzg. mit Vorrüstung	03/19-	KIT		314 578 900 113			60	27.2	13.9	104	2500		im KIT enthalten 314 585 300 113		inkl. WLC 2.0 für Fzg. mit Vorrüstung auch für Vivaro-e	S	FRE	C	E	D	L1	H	75
Opel Vivaro Kasten/Kombi inkl. Kugelplatte	05/01-09/14			314 364 600 001	→		60	21.0	12.3	85	2100		314 860 300 113 314 870 300 113	08/06-03/10 03/10-09/14	S S	FRE FRE	-- --	-- --	D1 D1	L1 L1	H H	60 60	
Opel Vivaro Kasten/Kombi inkl. Kugelplatte	08/06-03/10	KIT		314 364 900 113			60	23.0	12.3	85	2100		im KIT enthalten 314 860 300 113	08/06-03/10	S	FRE	--	--	D1	L1	H	60	
Opel Vivaro Kasten/Kombi inkl. Kugelplatte	03/10-09/14	KIT		314 870 900 113			60	23.0	12.3	85	2100		im KIT enthalten 314 870 300 113	03/10-09/14	S	FRE	--	--	D1	L1	H	60	
Opel Zafira auch für GSI (mit unsichtbarem Ausschnitt)	04/99-07/05			314 270 600 001	→		150	22.8	8.9	75	1500		314 245 300 113	→		S	FRE	--	E	D1	--	V	90
Opel Zafira Life auch für Zafira-e Life	03/19-			335 106 600 001			60	25.5	13.9	104	2500		314 585 300 113		inkl. WLC 2.0 für Fzg. mit Vorrüstung auch für Zafira-e Life	S	FRE	C	E	D	L1	H	75
Opel Zafira Life auch für Zafira-e Life inkl. Kugelplatte	03/19-			304 190 600 001			45	26.0	13.9	104	2500		314 585 300 113		inkl. WLC 2.0 für Fzg. mit Vorrüstung auch für Zafira-e Life	S	FRE	C	E	D	L1	H	75
Opel Zafira Life auch für Zafira-e Life für Fzg. mit Vorrüstung inkl. Kugelplatte	03/19-	KIT		314 576 900 113			45	27.7	13.9	104	2500		im KIT enthalten 314 585 300 113		inkl. WLC 2.0 für Fzg. mit Vorrüstung auch für Zafira-e Life	S	FRE	C	E	D	L1	H	75
Opel Zafira Life auch für Zafira-e Life für Fzg. mit Vorrüstung	03/19-	KIT		314 578 900 113			60	27.2	13.9	104	2500		im KIT enthalten 314 585 300 113		inkl. WLC 2.0 für Fzg. mit Vorrüstung auch für Zafira-e Life	S	FRE	C	E	D	L1	H	75

Opel Zafira Tourer nicht für CNG nicht für Kfz. mit Fahrradträgersystem Flex-Fix Um den optimalen Sitz des Stoßfängers zu gewährleisten, empfehlen wir die Montage eines Styroporträgers (beim Opel- Händler erhältlich).	01/12-06/19			314 438 600 001		60	27.0	9.9	75	1500		314 386 300 113			S	CAN	--	E	D	L1	V	90	
				314 437 600 001		60	27.0	9.9	75	1500													
		KIT			314 438 900 113		60	28.0	9.9	75	1500		im KIT enthalten 314 386 300 113			S	CAN	--	E	D	L1	V	90
		KIT			314 437 900 113		60	29.0	9.9	75	1500		im KIT enthalten 314 386 300 113			S	CAN	--	E	D	L1	V	90
Opel Zafira, Zafira Family auch für Facelift 01/08- nicht für CNG OPC-Version und Fzg. mit Sportstoßfänger: zusätzlicher Ausschnitt zum sichtbaren Ausschnitt erforderlich. Keine Klappe für Ausschnitt verfügbar.	07/05-04/15			314 293 600 001		75	17.5	9.6	75	1650		314 300 300 113	für Kfz. mit Zentralelektrik hinten (REC)	S	FRE	C	E	D	L1	H	45		
			KIT			314 293 900 113		75	18.5	9.6	75	1650		im KIT enthalten 314 300 300 113	für Kfz. mit Zentralelektrik hinten (REC)	S	FRE	C	E	D	L1	H	45
Opel Zafira, Zafira Family nicht für CNG	07/05-04/15			314 361 600 001		90	19.0	9.6	75	1650		300 210 300 113	für Kfz. ohne Zentralelektrik hinten (REC)	--	A	--	E1	D1	L1	V	90		
												314 300 300 113	für Kfz. mit Zentralelektrik hinten (REC)	S	FRE	C	E	D	L1	H	45		
		KIT			314 361 900 113		90	21.0	9.6	75	1650		im KIT enthalten 314 300 300 113	für Kfz. mit Zentralelektrik hinten (REC)	S	FRE	C	E	D	L1	H	45	



























Peugeot





























Peugeot 2008	06/13-07/19			315 189 600 001			120	18.0	6.7	55	1150		315 185 300 113	-07/19	S	CAN	C	E	D	L1	V	60
				315 190 600 001		120	21.0	6.7	55	1150												
	KIT		315 189 900 113		120	18.0	6.7	55	1150	im KIT enthalten 315 185 300 113	-07/19	S	CAN	C	E	D	L1	V	60			
	KIT		315 190 900 113		120	21.0	6.7	55	1150	im KIT enthalten 315 185 300 113	-07/19	S	CAN	C	E	D	L1	V	60			
Peugeot 2008 II nicht für e-2008	08/19-			315 275 600 001		90	22.3	7.8	95	1200		314 596 300 113	für Fzg. ohne Vorrüstung, nicht für e-2008	S	CAN	C	E2	D1	L1	V	75	
				315 269 600 001		60	26.0	7.8	95	1200												
Peugeot 2008 II für Fzg. ohne Vorrüstung nicht für e-2008	08/19-	KIT		315 275 900 113		90	24.0	7.8	95	1200	im KIT enthalten 314 596 300 113	für Fzg. ohne Vorrüstung, nicht für e-2008	S	CAN	C	E2	D1	L1	V	75		
		KIT		315 269 900 113		60	27.7	7.8	95	1200	im KIT enthalten 314 596 300 113										für Fzg. ohne Vorrüstung, nicht für e-2008	S
Peugeot 206 XS, Gti, CC, RC 99- XR/XT 04/03- 206+ 09- nicht für sw	08/98-12/12			315 170 600 001		90	16.0	6.8	50	1200	300 072 300 107			--	FRE	--	--	--	--	V		
											300 072 300 113										--	FRE
Peugeot 207 auch für 207 cc Cabrio, auch für 207 RC - 175 PS, auch für 207 Kasten Typ WG, auch für Sport	04/06-12/15			315 113 600 001		75	16.5	6.7	60	1200	304 402 300 107			S	CAN	C1	E	--	--	V	105	
											304 402 300 113											S
KIT		315 113 900 113		75	18.5	6.7	60	1200	im KIT enthalten 304 402 300 113			S	CAN	C1	E	D	L1	V	105			
Peugeot 207 sw / Kombi nicht für Outdoor nicht für RC (Doppelrohr- Auspuffanlage)	06/07-10/13			315 118 600 001		120	17.5	6.4	46	1150	304 402 300 107			S	CAN	C1	E	--	--	V	105	
											304 402 300 113											S
KIT		315 118 900 113		120	19.5	6.4	46	1150	im KIT enthalten 304 402 300 113			S	CAN	C1	E	D	L1	V	105			

Peugeot 208	04/12-05/19			315 184 600 001		60	12.0	7.2	53	1300		315 185 300 113	-05/19	S	CAN	C	E	D	L1	V	60
				315 185 600 001		60	12.0	7.2	53	1300											
		KIT		315 184 900 113		60	14.0	7.2	53	1300		im KIT enthalten 315 185 300 113	-05/19	S	CAN	C	E	D	L1	V	60
		KIT		315 185 900 113		60	14.0	7.2	53	1300		im KIT enthalten 315 185 300 113	-05/19	S	CAN	C	E	D	L1	V	60
Peugeot 208 II nicht für e-208	06/19-			314 597 600 001		75	25.0	7.2	83	1200		314 596 300 113	für Fzg. ohne Vorrüstung, nicht für e-208	S	CAN	C	E2	D1	L1	V	75
Peugeot 208 II für Fzg. ohne Vorrüstung nicht für e-208	06/19-	KIT		314 597 900 113		75	26.8	7.2	83	1200		im KIT enthalten 314 596 300 113	für Fzg. ohne Vorrüstung, nicht für e-208	S	CAN	C	E2	D1	L1	V	75
Peugeot 3008 nicht für Hybrid	06/09-09/16			315 157 600 001		90	22.0	9.2	70	1600		315 109 300 113		S	CAN	C	E	D	L1	V	105
				315 158 600 001		90	24.0	9.2	70	1600											
		KIT		315 157 900 113		90	24.0	9.2	70	1600		im KIT enthalten 315 109 300 113		S	CAN	C	E	D	L1	V	105
		KIT		315 158 900 113		90	26.0	9.2	70	1600		im KIT enthalten 315 109 300 113		S	CAN	C	E	D	L1	V	105
Peugeot 3008 auch für GT-Line nicht für Hyrid 4	10/16-			315 243 600 001		120	22.0	10.0	80	2000		315 229 300 113	10/16- inkl. WLC 2.0	S	CAN	C	E	D	L1	V	75
				315 244 600 001		120	24.0	10.0	80	2000											
		KIT		315 243 900 113		120	23.0	10.0	80	2000		im KIT enthalten 315 229 300 113	10/16- inkl. WLC 2.0	S	CAN	C	E	D	L1	V	75
		KIT		315 244 900 113		120	25.0	10.0	80	2000		im KIT enthalten 315 229 300 113	10/16- inkl. WLC 2.0	S	CAN	C	E	D	L1	V	75

Peugeot





























Peugeot

























Peugeot 3008 II Hybrid nur für Plugin-Hybrid				314 599 600 001		90	26.7	8.1	95	1270		315 229 300 113		10/19-	S	CAN	C	E	D	L1	V	75
Peugeot 308 II Fließheck T9 nicht für GTI auch für AdBlue	09/13-08/17	KIT		304 151 900 113		90	21.0	9.5	75	1750		im KIT enthalten 315 196 300 113		-08/17	S	CAN	C	E2	D	L1	V	75
Peugeot 308 II Fließheck T9 nicht für GT nicht für GTI auch für AdBlue	09/13-08/17	KIT		304 152 900 113		90	24.0	9.5	75	1750		im KIT enthalten 315 196 300 113		-08/17	S	CAN	C	E2	D	L1	V	75
Peugeot 308 II Fließheck T9 nicht für GT, GTI & GT-Line auch für AdBlue	09/13-06/21			304 151 600 001		90	21.0	9.5	75	1750		315 196 300 113		-08/17	S	CAN	C	E2	D	L1	V	75
				304 152 600 001		90	24.0	9.5	75	1750		315 252 300 113		09/17-06/21 inkl. WLC 2.0	S	CAN	C	E	D	L1	V	75
Peugeot 308 II Fließheck T9 nicht für GT, GTI & GT-Line auch für AdBlue	09/17-06/21	KIT		315 252 900 113		90	22.9	9.5	75	1750		im KIT enthalten 315 252 300 113		09/17-06/21 inkl. WLC 2.0	S	CAN	C	E	D	L1	V	75
Peugeot 308 II Fließheck T9 nicht für GT nicht für GTI	09/17-06/21	KIT		315 253 900 113		90	27.4	9.5	75	1750		im KIT enthalten 315 252 300 113		09/17-06/21 inkl. WLC 2.0	S	CAN	C	E	D	L1	V	75
Peugeot 308 III 5-Türer F auch für Plugin-Hybrid	07/21-			314 603 600 001		90	21.7	9.2	90	1650		314 602 300 113		07/21- auch für Plug-in Hybrid	S	CAN	C	E	D	L1	H	75
Peugeot 308 III 5-Türer F auch für Plug-in Hybrid	07/21-	KIT		314 603 900 113		90	24.2	9.2	90	1650		im KIT enthalten 314 602 300 113		07/21- auch für Plug-in Hybrid	S	CAN	C	E	D	L1	H	75
Peugeot 308 III sw F auch für Plugin-Hybrid	07/21-			314 604 600 001		90	20.0	9.2	108	1650		314 602 300 113		07/21- auch für Plug-in Hybrid	S	CAN	C	E	D	L1	H	75
				314 605 600 001		90	22.0	9.2	112	1650												
		KIT		314 604 900 113		90	22.0	9.2	108	1650		im KIT enthalten 314 602 300 113		07/21- auch für Plug-in Hybrid	S	CAN	C	E	D	L1	H	75
		KIT		314 605 900 113		90	24.0	9.2	108	1650		im KIT enthalten 314 602 300 113		07/21- auch für Plug-in Hybrid	S	CAN	C	E	D	L1	H	75

Peugeot 308 sw nicht für GT auch für AdBlue	05/14-08/17	KIT		304 151 900 113		90	21.0	9.5	75	1750		im KIT enthalten 315 196 300 113	-08/17	S	CAN	C	E2	D	L1	V	75
		KIT		304 152 900 113		90	24.0	9.5	75	1750		im KIT enthalten 315 196 300 113	-08/17	S	CAN	C	E2	D	L1	V	75
Peugeot 308 sw nicht für GT & GT-Line auch für AdBlue	05/14-02/18			304 151 600 001		90	21.0	9.5	75	1750		315 196 300 113	-08/17	S	CAN	C	E2	D	L1	V	75
				304 152 600 001		90	24.0	9.5	75	1750		315 252 300 113	09/17-02/18 inkl. WLC 2.0	S	CAN	C	E	D	L1	V	75
Peugeot 308 sw nicht für GT & GT-Line auch für AdBlue	09/17-02/18	KIT		315 252 900 113		90	22.9	9.5	75	1750		im KIT enthalten 315 252 300 113	09/17-02/18 inkl. WLC 2.0	S	CAN	C	E	D	L1	V	75
Peugeot 308 sw nicht für GT	09/17-02/18	KIT		315 253 900 113		90	27.4	9.5	75	1750		im KIT enthalten 315 252 300 113	09/17-02/18 inkl. WLC 2.0	S	CAN	C	E	D	L1	V	75
Peugeot 4007	09/07-12/12			340 094 600 001		90	27.0	10.9	100	2000		340 075 300 113		S	FRE	--	E	D	L	H	75
		KIT		340 094 900 113		90	29.0	10.9	100	2000		im KIT enthalten 340 075 300 113		S	FRE	--	E	D	L	H	75
Peugeot 4008	03/12-12/15			340 092 600 001		90	22.0	8.5	70	1400		340 093 300 113		S	A	--	--	D	L	H	60
				340 093 600 001		90	24.0	8.5	70	1400					S	A	--	--	D	L	H
		KIT		340 092 900 113		90	24.0	8.5	70	1400		im KIT enthalten 340 093 300 113		S	A	--	--	D	L	H	60
		KIT		340 093 900 113		90	26.0	8.5	70	1400		im KIT enthalten 340 093 300 113		S	A	--	--	D	L	H	60
Peugeot 407 Kombi / sw	05/04-07/08	KIT		315 104 900 113		90	29.0	10.4	75	1900		im KIT enthalten 304 401 300 113	-07/08 ->OPR11557	S	CAN	C1	E	D	L1	V	105
		KIT		315 105 900 113		90	31.4	10.4	75	1900		im KIT enthalten 304 401 300 113	-07/08 ->OPR11557	S	CAN	C1	E	D	L1	V	105

Peugeot









Peugeot







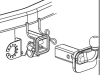

Peugeot 407 Kombi / sw	05/04-02/11			304 133 600 001		90	23.0	10.4	75	1900		304 401 300 113		-07/08 ->OPR11557	S	CAN	C1	E	D	L1	V	105
				304 135 600 001		90	25.4	10.4	75	1900												
Peugeot 407 Limousine	03/04-03/08			304 135 600 001		90	25.4	10.4	75	1900		304 401 300 113		-07/08 - >OPR11557	S	CAN	C1	E	D	L1	V	105
			KIT		315 105 900 113		90	31.4	10.4	75												
Peugeot 5008 nicht für Kfz. mit Ad-Blue-Tank	09/09-12/16			315 177 600 001		120	21.0	10.0	75	1550		304 400 300 113		-12/11	S	CAN	C1	E	D	L1	H	105
				315 178 600 001		90	22.5	9.7	80	1700												
Peugeot 5008 nicht für Kfz. mit Ad-Blue-Tank	01/12-03/14	KIT		315 177 900 113		120	23.0	10.0	75	1550		im KIT enthalten 315 109 300 113		01/12-03/14	S	CAN	C	E	D	L1	V	105
				315 178 900 113		90	24.5	9.7	80	1700												
Peugeot 5008	12/16-			314 585 600 001			20.0	9.9	72	1800		315 229 300 113		12/16- inkl. WLC 2.0	S	CAN	C	E	D	L1	V	75
				314 586 600 001		60	21.6	9.9	72	1800												
		KIT		314 585 900 113		60	23.0	9.9	72	1800	im KIT enthalten 315 229 300 113	12/16- inkl. WLC 2.0										
		KIT		314 586 900 113		60	24.6	9.9	72	1800	im KIT enthalten 315 229 300 113	12/16- inkl. WLC 2.0										
Peugeot 508 II nicht für GT & PSE nicht für Plugin Hybrid	09/18-			315 261 600 001		60	26.6	9.6	75	1800		315 228 300 113		09/18- für Fzg. ohne Vorrüstung inkl. WLC 2.0	S	CAN	C	E	D1	L1	V	75
				315 262 600 001		60	28.1	9.6	75	1800												













Peugeot 508 II für Fzg. ohne Vorrüstung nicht für GT & PSE nicht für Plugin Hybrid	09/18-	KIT		315 261 900 113		60	28.3	9.6	75	1800		im KIT enthalten 315 228 300 113	09/18- für Fzg. ohne Vorrüstung inkl. WLC 2.0	S	CAN	C	E	D1	L1	V	75	
		KIT		315 262 900 113		60	29.9	9.6	75	1800		im KIT enthalten 315 228 300 113	09/18- für Fzg. ohne Vorrüstung inkl. WLC 2.0	S	CAN	C	E	D1	L1	V	75	
Peugeot 508 II sw nicht für GT & PSE nicht für Plugin Hybrid	12/18-			315 261 600 001		60	26.6	9.6	75	1800		315 228 300 113	12/18- für Fzg. ohne Vorrüstung inkl. WLC 2.0	S	CAN	C	E	D1	L1	V	75	
				315 262 600 001		60	28.1	9.6	75	1800												
		KIT		315 262 900 113		60	29.9	9.6	75	1800		im KIT enthalten 315 228 300 113	12/18- für Fzg. ohne Vorrüstung inkl. WLC 2.0	S	CAN	C	E	D1	L1	V	75	
Peugeot 508 II sw für Fzg. ohne Vorrüstung nicht für GT & PSE nicht für Plugin Hybrid	12/18-	KIT		315 261 900 113		60	28.3	9.6	75	1800		im KIT enthalten 315 228 300 113	12/18- für Fzg. ohne Vorrüstung inkl. WLC 2.0	S	CAN	C	E	D1	L1	V	75	
Peugeot 508 Kombi nicht für GT nicht für RXH	03/11-08/18			315 180 600 001		90	20.5	10.2	75	1900												
				315 182 600 001		90	20.5	10.2	75	1900												
Peugeot 508 Limousine nicht für GT	03/11-08/18			315 175 600 001		90	20.5	10.2	75	1900												
Peugeot Bipper + Tepee nicht für Kfz. mit Gasbetrieb	02/08-07/18			306 349 600 001		150	16.5	7.5	75	1300		306 580 300 113		S	FRE	--	E	D1	L1	V	120	
		KIT		306 349 900 113		150	18.5	7.5	75	1300		im KIT enthalten 306 580 300 113		S	FRE	--	E	D1	L1	V	120	
Peugeot Bipper + Tepee inkl. Kugelplatte nicht für Kfz. mit Gasbetrieb	02/08-07/18			306 351 600 001		150	17.0	7.5	75	1300		306 580 300 113		S	FRE	--	E	D1	L1	V	120	
Peugeot Boxer Kasten/Kombi inkl. Kugelplatte	02/95-06/06			306 329 600 001	→	60	29.0	12.5	130	2000												

Peugeot















Peugeot







Peugeot Boxer Kasten/Kombi Bei Kfz. mit langem Überhang L4/XL bitte einen Satz Distanzröhrchen zur Rahmenverstärkung mitbestellen, Art.-Nr. 906270650003. Bei Fahrzeugen 03/08- fehlen in der Karosserie werkseitig Bohrungen. Diese müssen nachträglich eingebracht werden. Die Montagezeit erhöht sich dadurch auf ca. 120 Min.	06/06-		306 491 600 001		120	32.0	16.9	150	3000	306 510 300 113	-02/11 bis Fg.-Nr. 1948840	S	FRE	--	E	D1	L1	V	105	
										306 553 300 113	02/11- ab Fg.- Nr. 1948841	S	FRE	--	E	D1	L1	V	105	
Peugeot Boxer Kasten/Kombi inkl. Kugelplatte Bei Kfz. mit langem Überhang L4/XL bitte einen Satz Distanzröhrchen zur Rahmenverstärkung mitbestellen, Art.-Nr. 906270650003. Bei Fahrzeugen 03/08- fehlen in der Karosserie werkseitig Bohrungen. Diese müssen nachträglich eingebracht werden. Die Montagezeit erhöht sich dadurch auf ca. 120 Min.	06/06-		306 490 600 001		120	32.0	16.9	150	3000	306 510 300 113	-02/11 bis Fg.-Nr. 1948840	S	FRE	--	E	D1	L1	V	105	
										306 553 300 113	02/11- ab Fg.- Nr. 1948841	S	FRE	--	E	D1	L1	V	105	
Peugeot Boxer Kasten/Kombi inkl. Kugelplatte Bei Fahrzeugen 03/08- fehlen in der Karosserie werkseitig Bohrungen. Diese müssen nachträglich eingebracht werden. Die Montagezeit erhöht sich dadurch auf ca. 120 Min.	06/06-		306 357 600 001	→ 	60	29.0	15.8	150	3000	306 510 300 113	-02/11 bis Fg.-Nr. 1948840	S	FRE	--	E	D1	L1	V	105	
										306 553 300 113	02/11- ab Fg.- Nr. 1948841	S	FRE	--	E	D1	L1	V	105	
Peugeot Boxer Kasten/Kombi inkl. Kugelplatte für Fahrzeuge bis 6 m Länge 51 mm Vierkantaufnahme	06/06-		306 563 600 001		60	25.7	15.1	100	2500	306 510 300 113	-02/11 bis Fg.-Nr. 1948840	S	FRE	--	E	D1	L1	V	105	
										306 553 300 113	02/11- ab Fg.- Nr. 1948841	S	FRE	--	E	D1	L1	V	105	
Peugeot Boxer Kasten/Kombi Kasten / Kombi Bei Kfz. mit langem Überhang L4/XL bitte einen Satz Distanzröhrchen zur Rahmenverstärkung mitbestellen, Art.-Nr. 906270650003. Bei Fahrzeugen 03/08- fehlen in der Karosserie werkseitig Bohrungen. Diese müssen nachträglich eingebracht werden. Die Montagezeit erhöht sich dadurch auf ca. 120 Min.	06/06-02/11	KIT		306 271 900 113		120	34.0	16.9	150	3000	im KIT enthalten 306 510 300 113	-02/11 bis Fg.-Nr. 1948840	S	FRE	--	E	D1	L1	V	105

Peugeot Boxer Kasten/Kombi inkl. Kugelplatte Bei Kfz. mit langem Überhang L4/XL bitte einen Satz Distanzröhrchen zur Rahmenverstärkung mitbestellen, Art.-Nr. 906270650003. Bei Fahrzeugen 03/08- fehlen in der Karosserie werkseitig Bohrungen. Diese müssen nachträglich eingebracht werden. Die Montagezeit erhöht sich dadurch auf ca. 120 Min.	06/06-02/11	KIT		306 330 900 113			120	34.0	16.9	150	3000				im KIT enthalten 306 510 300 113		-02/11 bis Fg.-Nr. 1948840	S	FRE	--	E	D1	L1	V	105
Peugeot Boxer Kasten/Kombi Bei Kfz. mit langem Überhang L4/XL bitte einen Satz Distanzröhrchen zur Rahmenverstärkung mitbestellen, Art.-Nr. 906270650003. Bei Fahrzeugen 03/08- fehlen in der Karosserie werkseitig Bohrungen. Diese müssen nachträglich eingebracht werden. Die Montagezeit erhöht sich dadurch auf ca. 120 Min.	02/11-	KIT		306 491 900 113			120	32.8	16.9	150	3000				im KIT enthalten 306 553 300 113		02/11- ab Fg.- Nr. 1948841	S	FRE	--	E	D1	L1	V	105
Peugeot Boxer Kasten/Kombi inkl. Kugelplatte Bei Fahrzeugen 03/08- fehlen in der Karosserie werkseitig Bohrungen. Diese müssen nachträglich eingebracht werden. Die Montagezeit erhöht sich dadurch auf ca. 120 Min.	02/11-	KIT		306 553 900 113	→		>150	31.0	15.8	150	3000				im KIT enthalten 306 553 300 113		02/11- ab Fg.- Nr. 1948841	S	FRE	--	E	D1	L1	V	105
Peugeot Boxer Kasten/Kombi inkl. Kugelplatte Bei Kfz. mit langem Überhang L4/XL bitte einen Satz Distanzröhrchen zur Rahmenverstärkung mitbestellen, Art.-Nr. 906270650003. Bei Fahrzeugen 03/08- fehlen in der Karosserie werkseitig Bohrungen. Diese müssen nachträglich eingebracht werden. Die Montagezeit erhöht sich dadurch auf ca. 120 Min.	02/11-	KIT		306 490 900 113			120	32.2	16.9	150	3000				im KIT enthalten 306 553 300 113		02/11- ab Fg.- Nr. 1948841	S	FRE	--	E	D1	L1	V	105
Peugeot Boxer Pritsche inkl. Kugelplatte	02/95-06/06			306 329 600 001	→		60	29.0	12.5	130	2000			300 052 300 113 300 060 300 113		03/02- 03/02-	-- --	FRE C2	-- --	E1 E1	D1 D1	-- L1	V H	45	



Peugeot Expert / Traveller inkl. Kugelplatte	07/16-10/19	KIT		304 190 900 113			45	31.0	13.9	104	2500		im KIT enthalten 304 157 300 113		-10/19	S	CAN	C	E	D	L1	H	90	
Peugeot Expert / Traveller	07/16-10/19	KIT		335 106 900 113			60	28.5	13.9	104	2500		im KIT enthalten 304 157 300 113		-10/19	S	CAN	C	E	D	L1	H	90	
Peugeot Expert / Traveller auch für e-Expert / e-Traveller für Fzg. mit Vorrüstung inkl. Kugelplatte	11/19-	KIT		314 576 900 113			45	27.7	13.9	104	2500		im KIT enthalten 314 585 300 113		11/19- inkl. WLC 2.0 für Fzg. mit Vorrüstung auch für e-Expert / e- Traveller	S	FRE	C	E	D	L1	H	75	
Peugeot Expert / Traveller auch für e-Expert / e-Traveller für Fzg. mit Vorrüstung	11/19-	KIT		314 578 900 113			60	27.2	13.9	104	2500		im KIT enthalten 314 585 300 113		11/19- inkl. WLC 2.0 für Fzg. mit Vorrüstung auch für e-Expert / e- Traveller	S	FRE	C	E	D	L1	H	75	
Peugeot Partner Kasten/Kombi	11/96-04/08			304 054 600 001			90	14.8	7.8	70	1350		304 054 300 113			S	FRE	--	E1	D1	--	V	75	
		KIT		304 054 900 113			90	16.8	7.8	70	1350		im KIT enthalten 304 054 300 113			S	FRE	--	E1	D1	--	V	75	
Peugeot Partner Kasten/Kombi langer Überhang + Tepee, Fzg.- Länge = 4628 mm	08-11/11	KIT		304 129 900 113			90	18.3	8.7	64	1600		im KIT enthalten 304 400 300 113		-11/11 -> OPR12775	S	CAN	C1	E	D	L1	H	105	
Peugeot Partner Kasten/Kombi langer Überhang + Tepee, Fzg.- Länge = 4628 mm	08-08/18			304 129 600 001			90	16.3	8.7	64	1600		304 400 300 113		-11/11 -> OPR12775	S	CAN	C1	E	D	L1	H	105	
													304 402 300 107		11/11- OPR12776->	S	CAN	C1	E	--	--	V	105	
														304 402 300 113		11/11- OPR12776->	S	CAN	C1	E	D	L1	V	105
Peugeot Partner Kasten/Kombi kurzer Überhang + Tepee, Fzg.- Länge = 4380 mm	04/08-11/11	KIT		304 091 900 113			90	17.0	8.7	64	1600		im KIT enthalten 304 400 300 113		-11/11 -> OPR12775	S	CAN	C1	E	D	L1	H	105	
		KIT		304 092 900 113			90	21.0	8.7	64	1600		im KIT enthalten 304 400 300 113		-11/11 -> OPR12775	S	CAN	C1	E	D	L1	H	105	
Peugeot Partner Kasten/Kombi kurzer Überhang + Tepee, Fzg.- Länge = 4380 mm nicht für Partner Electric	04/08-08/18			304 091 600 001			90	15.0	8.7	64	1600		304 400 300 113		-11/11 -> OPR12775	S	CAN	C1	E	D	L1	H	105	
													304 402 300 107		11/11- OPR12776->	S	CAN	C1	E	--	--	V	105	
								90	19.0	8.7	64	1600		304 402 300 113		11/11- OPR12776->	S	CAN	C1	E	D	L1	V	105

Peugeot

Peugeot Partner Kasten/Kombi L1 auch für Rifter inkl. Kugelplatte	09/18-		304 118 600 001			90	17.0	8.4	64	1600		314 594 300 113			S	A	C	E	D	L	V	90	
Peugeot Partner Kasten/Kombi L1 auch für Rifter	09/18-		304 207 600 001			60	20.0	8.6	75	1500		314 594 300 113			S	A	C	E	D	L	V	90	
			304 209 600 001			60	20.5	8.6	75	1500					S	A	C	E	D	L	V	90	
		KIT		304 207 900 113			60	21.2	8.6	75	1500		im KIT enthalten 314 594 300 113			S	A	C	E	D	L	V	90
		KIT		304 209 900 113			60	21.8	8.6	75	1500		im KIT enthalten 314 594 300 113			S	A	C	E	D	L	V	90
Peugeot Partner Kasten/Kombi L2 auch für Rifter	09/18-		304 210 600 001			60	21.0	8.6	75	1500		314 594 300 113			S	A	C	E	D	L	V	90	
			304 212 600 001			60	21.5	8.6	75	1500					S	A	C	E	D	L	V	90	
		KIT		304 212 900 113			60	22.8	8.6	75	1500		im KIT enthalten 314 594 300 113			S	A	C	E	D	L	V	90
Peugeot Partner Origin	04/08-06/18		304 054 600 001			90	14.8	7.8	70	1350		304 054 300 113			S	FRE	--	E1	D1	--	V	75	
		KIT		304 054 900 113			90	16.8	7.8	70	1350		im KIT enthalten 304 054 300 113			S	FRE	--	E1	D1	--	V	75
Peugeot Rifter L1 auch für Partner	09/18-		304 207 600 001			60	20.0	8.6	75	1500		314 594 300 113		inkl. WLC 2.0	S	A	C	E	D	L	V	90	
			304 209 600 001			60	20.5	8.6	75	1500					S	A	C	E	D	L	V	90	
		KIT		304 207 900 113			60	21.2	8.6	75	1500		im KIT enthalten 314 594 300 113		inkl. WLC 2.0	S	A	C	E	D	L	V	90





















Peugeot Rifter L2 auch für Partner	09/18-		304 210 600 001			60	21.0	8.6	75	1500		314 594 300 113	inkl. WLC 2.0	S	A	C	E	D	L	V	90	
			304 212 600 001			60	21.5	8.6	75	1500												
	KIT		304 210 900 113			60	22.2	8.6	75	1500		im KIT enthalten 314 594 300 113	inkl. WLC 2.0	S	A	C	E	D	L	V	90	
	KIT		304 212 900 113			60	22.8	8.6	75	1500		im KIT enthalten 314 594 300 113	inkl. WLC 2.0	S	A	C	E	D	L	V	90	
Peugeot Rifter L1 auch für Partner inkl. Kugelplatte	09/18-		304 118 600 001			90	17.0	8.4	64	1600		314 594 300 113	inkl. WLC 2.0	S	A	C	E	D	L	V	90	
Peugeot Rifter L1 auch für Partner	09/18	KIT		304 209 900 113			60	21.8	8.6	75	1500		im KIT enthalten 314 594 300 113	inkl. WLC 2.0	S	A	C	E	D	L	V	90

























Polestar

Polestar 2 P	04/19-			320 187 600 001		60	27.3	9.3	90	1500		320 187 300 113		04/19-	S	A	--	E2	D	L1	H	60
		KIT		320 187 900 113		60	22.5	9.3	90	1500		im KIT enthalten 320 187 300 113		04/19-	S	A	--	E2	D	L1	H	60

















Porsche Cayenne Abdeckklappe für Stoßfängerausschnitt bitte beim Porsche-Händler bestellen. nicht für Kfz. mit Reserverad auf der Heckklappe	12/02-04/10	KIT		321 500 900 113	→	150	36.0	16.4	140	3500		im KIT enthalten 321 500 300 113	→	-04/10	S	CAN	--	E	D	L1	H	45
Porsche Cayenne nicht für Kfz. mit Reserverad auf der Heckklappe	12/02-10/17			321 735 600 001		150	33.5	16.4	140	3500		321 500 300 113	→	-04/10	S	CAN	--	E	D	L1	H	45
												321 765 300 113		04/10-10/17	S	CAN	C	E	D	L1	V	180
Porsche Cayenne Modelle 12/02-04/10: Abdeckklappe für Stoßfängerausschnitt bitte beim Porsche-Händler bestellen. nicht für Kfz. mit Reserverad auf der Heckklappe	12/02-10/17			321 736 600 001		150	34.0	16.4	140	3500		321 500 300 113	→	-04/10	S	CAN	--	E	D	L1	H	45
												321 765 300 113		04/10-10/17	S	CAN	C	E	D	L1	V	180
Porsche Cayenne nicht für Kfz. mit Reserverad auf der Heckklappe	04/10-10/17	KIT		321 736 900 113		150	36.0	16.4	140	3500		im KIT enthalten 321 765 300 113		04/10-10/17	S	CAN	C	E	D	L1	V	180
Porsche Cayenne (9YA)	11/17-			322 064 600 001		60	27.0	15.7	191	3500												
Porsche Macan	04/14-			327 068 600 001		90	21.0	12.1	100	2400		327 068 300 113			S	CAN	C	E	D	L1	H	30
		KIT		327 068 900 113		90	23.0	12.1	100	2400		im KIT enthalten 327 068 300 113			S	CAN	C	E	D	L1	H	30





















Renault

Renault Alaskan inkl. Kugelplatte	09/17-		332 353 600 001			30	30.6	17.2	190	3500		332 354 300 113			S	FRE	--	E2	D1	L1	H	90
		KIT		332 337 900 113			30	32.0	17.2	190	3500		im KIT enthalten 332 354 300 113			S	FRE	--	E2	D1	L1	H
Renault Arkana LCM	03/21-		316 494 600 001			60	19.8	8.8	108	1500		316 493 300 113	03/21-	S	FRE	--	E	D1	L1	H	60	
			316 495 600 001			60	22.8	8.8	108	1500												
		KIT		316 494 900 113			60	21.5	8.8	108	1500		im KIT enthalten 316 493 300 113	03/21-	S	FRE	--	E	D1	L1	H	60
		KIT		316 495 900 113			60	24.4	8.8	108	1500		im KIT enthalten 316 493 300 113	03/21-	S	FRE	--	E	D1	L1	H	60
Renault Captur I	05/13-19		316 354 600 001			90	14.0	7.1	75	1200		316 337 300 113		S	A	--	E2	D1	L1	H	90	
			316 355 600 001			90	16.0	7.1	75	1200												
		KIT		316 354 900 113			90	16.0	7.1	75	1200		im KIT enthalten 316 337 300 113		S	A	--	E2	D1	L1	H	90
		KIT		316 355 900 113			90	18.0	7.1	75	1200		im KIT enthalten 316 337 300 113		S	A	--	E2	D1	L1	H	90
Renault Captur II auch für AdBlue auch für Plugin Hybrid Bei Fzg. mit Plastik-Pralldämpfer werden Renault-Halter 82 04 269 02R und 85 04 282 73R benötigt.	01/20-		316 486 600 001			60	24.0	9.1	106	1500		316 482 300 113			S	A	C1	E2	D	L1	V	60















Renault Captur II auch für AdBlue auch für Plugin Hybrid	01/20-		316 487 600 001		60	24.9	9.1	106	1500	316 482 300 113			S	A	C1	E2	D	L1	V	60	
		KIT		316 486 900 113		60	25.9	9.1	106	1500	im KIT enthalten 316 482 300 113			S	A	C1	E2	D	L1	V	60
		KIT		316 487 900 113		60	26.7	9.1	106	1500	im KIT enthalten 316 482 300 113			S	A	C1	E2	D	L1	V	60
Renault Clio II Phase I + II, nicht für Phase IV, nicht für Clio Sport V6	09/98-10/05		316 187 600 001		90	14.5	6.2	75	1200	300 072 300 113		-05/01 (Phase I)	--	FRE	--	--	D1	L1	V		
Renault Clio III BR Phase I + II nicht für Clio Sport 197/201 PS nicht für RS-Cup nicht für GT	10/05-11/12		316 354 600 001		90	14.0	7.1	75	1200	316 252 300 113		-11/12	S	FRE	--	--	D1	L1	H	45	
			316 355 600 001		90	16.0	7.1	75	1200												
		KIT		316 251 900 113		60	15.0	7.1	75	1200	im KIT enthalten 316 252 300 113		-11/12	S	FRE	--	--	D1	L1	H	45
		KIT		316 252 900 113		90	17.0	7.1	75	1200	im KIT enthalten 316 252 300 113		-11/12	S	FRE	--	--	D1	L1	H	45
Renault Clio IV Fließheck BH nicht für GT nicht für Modell Initiale	11/12-06/19		316 354 600 001		90	14.0	7.1	75	1200	316 337 300 113		-06/19	S	A	--	E2	D1	L1	H	90	
			316 355 600 001		90	16.0	7.1	75	1200												
		KIT		316 354 900 113		90	16.0	7.1	75	1200	im KIT enthalten 316 337 300 113		-06/19	S	A	--	E2	D1	L1	H	90
		KIT		316 355 900 113		90	18.0	7.1	75	1200	im KIT enthalten 316 337 300 113		-06/19	S	A	--	E2	D1	L1	H	90
Renault Clio IV Grandtour	03/13-12/20		316 336 600 001		60	15.0	7.1	75	1200	316 337 300 113			S	A	--	E2	D1	L1	H	90	
		KIT		316 336 900 113		60	17.0	7.1	75	1200	im KIT enthalten 316 337 300 113			S	A	--	E2	D1	L1	H	90

Renault





















Renault Clio V (BF) auch für AdBlue	06/19-		316 481 600 001		75	22.9	6.1	74	900	316 482 300 113				S	A	C1	E2	D	L1	V	60
			316 482 600 001		75	24.2	6.1	74	900												
	KIT		316 481 900 113		75	24.6	6.1	74	900	im KIT enthalten 316 482 300 113				S	A	C1	E2	D	L1	V	60
	KIT		316 482 900 113		75	25.9	6.1	74	900	im KIT enthalten 316 482 300 113				S	A	C1	E2	D	L1	V	60
Renault Espace kurzer Radstand	09/02-05/15		316 195 600 001		55	31.0	11.3	80	2000	300 078 300 113				--	FRE	--	--	D1	L1	V	
Renault Espace nicht für AdBlue	06/15-10/19	KIT		316 387 900 113		120	29.0	11.0	80	2000	im KIT enthalten 316 403 300 113	06/15-10/19		S	FRE	--	E2	D1	L1	H	90
Renault Espace nicht für AdBlue	06/15-04/23		316 387 600 001		120	25.0	11.0	80	2000	316 403 300 113	06/15-10/19			S	FRE	--	E2	D1	L1	H	90
Renault Express nicht für Kfz. mit Einparkhilfe	05/21-		316 333 600 001		60	19.5	7.3	75	1200												
			316 334 600 001		60	19.5	7.3	75	1200												
Renault Grand Kangoo 7-Sitzer nicht für AdBlue	02/08-04/13	KIT		316 268 900 113		60	25.0	8.2	75	1350	im KIT enthalten 316 440 300 113		-04/13 nicht für Kfz mit Start/Stop- Automatik	S	FRE	--	E2	D1	L1	H	45
		KIT		316 269 900 113		60	25.0	8.2	75	1350	im KIT enthalten 316 440 300 113		-04/13 nicht für Kfz mit Start/Stop- Automatik	S	FRE	--	E2	D1	L1	H	45
Renault Grand Kangoo 7-Sitzer nicht für AdBlue	02/08-04/21		316 268 600 001		60	23.0	8.2	75	1350	316 353 300 113	05/13-			S	FRE	--		D1	L1	H	60
			316 269 600 001		60	23.0	8.2	75	1350	316 440 300 113	-04/13 nicht für Kfz mit Start/Stop- Automatik			S	FRE	--	E2	D1	L1	H	45

















Renault Grand Kangoo 7-Sitzer nicht für AdBlue	05/13-04/21	KIT		316 352 900 113		60	25.0	8.2	75	1350		im KIT enthalten 316 353 300 113	05/13-	S	FRE	--		D1	L1	H	60	
		KIT		316 353 900 113		60	25.0	8.2	75	1350		im KIT enthalten 316 353 300 113	05/13-	S	FRE	--		D1	L1	H	60	
Renault Grand Modus F nicht für Kfz. mit Heckträgersystem Velofix	01/08-12/12			316 354 600 001		90	14.0	7.1	75	1200		300 210 300 113		--	A	--	E1	D1	L1	V	90	
				316 355 600 001		90	16.0	7.1	75	1200												
Renault Grand Scenic	04/09-08/16			316 297 600 001		90	21.4	8.2	75	1300		316 297 300 113		S	A	--	--	D1	L1	H	60	
		KIT		316 297 900 113		90	23.4	8.2	75	1300		im KIT enthalten 316 297 300 113		S	A	--	--	D1	L1	H	60	
Renault Grand Scenic	12/16-			316 431 600 001			25.3	10.2	75	1850		316 368 300 113		S	FRE	--	E	D1	L1	H	90	
				316 432 600 001		60	27.3	10.2	75	1850												
		KIT		316 431 900 113			28.0	10.2	75	1850		im KIT enthalten 316 368 300 113		S	FRE	--	E	D1	L1	H	90	
		KIT		316 432 900 113		60	29.5	10.2	75	1850		im KIT enthalten 316 368 300 113		S	FRE	--	E	D1	L1	H	90	
Renault Kadjar	06/15-12/18			316 390 600 001		120	21.0	9.8	80	1800		316 404 300 113	-12/18	S	FRE	--	E2	D1	L1	H	90	
				316 391 600 001		120	22.0	9.8	80	1800												
		KIT		316 390 900 113		120	22.0	9.8	80	1800		im KIT enthalten 316 404 300 113	-12/18	S	FRE	--	E2	D1	L1	H	90	
		KIT		316 391 900 113		120	23.0	9.8	80	1800		im KIT enthalten 316 404 300 113	-12/18	S	FRE	--	E2	D1	L1	H	90	

Renault

Renault Kangoo III nicht für Fahrzeuge mit AHK- Vorbereitung nicht für Fahrzeuge mit Reserverrad	07/21-			316 492 600 001		90	26.7	9.4	114	1500		316 493 300 113	07/21-	S	FRE	--	E	D1	L1	H	60
Renault Kangoo III FJ/KJ für Fzg. ohne AHK-Vorbereitung für Fzg. ohne Reserverad	07/21-	KIT		316 492 900 113		90	28.3	9.4	114	1500		im KIT enthalten 316 493 300 113	07/21-	S	FRE	--	E	D1	L1	H	60
Renault Koleos auch für Phase I + II 09/11-	09/08-12/15			316 226 600 001		40	21.7	10.5	100	2000											
				316 227 600 001		40	23.8	10.5	100	2000											
Renault Koleos II Ab Facelift 2019 muss der AdBlue Tank demontiert werden.	04/17-			316 454 600 001		75	27.7	10.8	80	2000		316 437 300 113	-09/20	S	FRE	C	E2	D1	L1	H	75
Renault Koleos II Ab Facelift 2019 muss der AdBlue Tank demontiert werden.	04/17-09/20	KIT		316 454 900 113		75	28.2	10.8	80	2000		im KIT enthalten 316 437 300 113	-09/20	S	FRE	C	E2	D1	L1	H	75
Renault Master Kasten/Kombi X62B Frontantrieb inkl. Kugelplatte	03/10-			316 318 600 001		60	19.3	14.3	100	2500		316 300 300 107	für Fzg. ohne Zentralsteckver- bindung	S	FRE	--	E2	--	--	H	45
												316 300 300 113	für Fzg. ohne Zentralsteckver- bindung	S	FRE	--	E2	D1	L1	H	45
												316 318 300 113	für Fzg. mit Zentralsteck- verbindung	S	FRE	--	E2	D1	L1	H	15
Renault Master Kasten/Kombi X62B Frontantrieb inkl. Kugelplatte für Fzg. ohne Zentralsteckverbindung	03/10-	KIT		316 318 900 113		60	21.0	14.3	100	2500		im KIT enthalten 316 300 300 113	für Fzg. ohne Zentralsteckver- bindung	S	FRE	--	E2	D1	L1	H	45
Renault Master Pritsche Front- + Heckantrieb inkl. Kugelplatte nicht für Fzg. mit Doppelbereifung	07/10-			316 347 600 001		60	16.5	13.7	85	2300		316 319 300 113	für Fzg. mit Vorrüstung	S	FRE	--	E1	D1	--	H	15
Renault Mégane 5-Türer nicht für GT/GT-Line	02/16-			316 448 600 001		60	27.3	9.6	75	1850		316 359 300 107	-04/20	S	FRE	--	E2	--	--	V	90
												316 359 300 113	-04/20	S	FRE	--	E2	D1	L1	V	90













Renault

Renault Megane E-Tech	12/21-			316 496 600 001		90	20.0	6.4	75	900																
				316 497 600 001		90	22.0	6.4	75	900																
Renault Mégane Fließheck 3-/5-Türer nicht für GT	11/02-11/08			316 352 600 001		120	18.0	8.7	75	1500		300 072 300 107	-12/05	--	FRE	--	--	--	--	V						
				316 363 600 001		120	21.0	8.7	75	1500		300 072 300 113	-12/05	--	FRE	--	--	D1	L1	V						
Renault Mégane Grandtour nicht für GT	06/09-03/16			316 289 600 001		90	20.5	7.7	75	1300		316 290 300 113		S	A	--	--	D1	L1	V	60					
			KIT		316 289 900 113		90	22.5	7.7	75	1300		im KIT enthalten 316 290 300 113		S	A	--	--	D1	L1	V	60				
Renault Mégane III 5-Türer nicht für GT nicht für Generation	11/08-01/16			316 352 600 001		120	18.0	8.7	75	1500		300 210 300 113		--	A	--	E1	D1	L1	V	90					
				316 363 600 001		120	21.0	8.7	75	1500																
Renault Mégane III Coupé nicht für Sport 250 PS nicht für GT-Line nicht für Generation	01/09-08/15			316 352 600 001		120	18.0	8.7	75	1500		300 210 300 113		--	A	--	E1	D1	L1	V	90					
				316 363 600 001		120	21.0	8.7	75	1500																
Renault Mégane IV Fließheck nicht für GT + GT line	09/16--04/20	KIT		316 358 900 113		75	24.2	10.0	75	1900		im KIT enthalten 316 359 300 113	-04/20	S	FRE	--	E2	D1	L1	V	90					
				316 359 900 113		75	25.2	10.0	75	1900		im KIT enthalten 316 359 300 113	-04/20	S	FRE	--	E2	D1	L1	V	90					
Renault Mégane IV Fließheck nicht für GT + GT line	09/16-			316 358 600 001		75	21.3	10.0	75	1900		316 359 300 107	-04/20	S	FRE	--	E2	--	--	V	90					
				316 448 600 001		60	27.3	9.6	75	1850		316 359 300 113	-04/20	S	FRE	--	E2	D1	L1	V	90					
												316 447 300 113	05/20-	S	FRE	--	E2	D1	L1	H	60					

























Renault Mégane IV Grandtour nicht für E-Tech	04/16-		316 388 600 001		60	29.2	10.2	75	1850	316 359 300 107		-04/20	S	FRE	--	E2	--	--	V	90	
			316 389 600 001		60	30.0	10.2	75	1850			316 359 300 113	-04/20	S	FRE	--	E2	D1	L1	V	90
												316 447 300 113	05/20-	S	FRE	--	E2	D1	L1	H	60
Renault Mégane cc Cabrio	04/10-08/15		316 320 600 001		120	22.1	6.1	75	750	300 210 300 113			--	A	--	E1	D1	L1	V	90	
Renault Modus II nicht für Kfz. mit Heckträgersystem Velofix	01/08-12/12		316 283 600 001		60	18.0	5.8	75	900	300 210 300 113			--	A	--	E1	D1	L1	V	90	
Renault Scenic nicht für Grand Scenic, nicht für Conquest	07/03-06/09		316 352 600 001		120	18.0	8.7	75	1500	316 207 300 113			S	FRE	--	E2	D1		H	45	
			316 363 600 001		120	21.0	8.7	75	1500												
		KIT		316 206 900 113		90	21.0	8.1	75	1350	im KIT enthalten 316 207 300 113			S	FRE	--	E2	D1		H	45
		KIT		316 207 900 113		90	22.0	8.1	75	1350	im KIT enthalten 316 207 300 113			S	FRE	--	E2	D1		H	45
Renault Scenic auch für Scenic Xmod	06/09-08/16		316 352 600 001		120	18.0	8.7	75	1500	316 294 300 107		-08/16	S	A	--	--	--	--	H	60	
			316 363 600 001		120	21.0	8.7	75	1500	316 294 300 113		-08/16	S	A	--	--	D1	L1	H	60	
		KIT		316 292 900 113		90	20.3	7.9	75	1300	im KIT enthalten 316 294 300 113		-08/16	S	A	--	--	D1	L1	H	60
		KIT		316 294 900 113		90	24.4	7.9	75	1300	im KIT enthalten 316 294 300 113		-08/16	S	A	--	--	D1	L1	H	60
Renault Talisman Grandtour nicht für Kfz. mit sensorgesteuerter Heckklappe (Fußsensor)	04/16--05/20	KIT		316 407 900 113		90	27.4	10.0	75	1850	im KIT enthalten 316 407 300 113		-05/20	S	FRE	--	E2	D1	L1	H	75
Renault Talisman Grandtour nicht für Kfz. mit sensorgesteuerter Heckklappe (Fußsensor)	04/16-02/22			316 407 600 001		75	24.2	10.1	75	1850	316 407 300 113		-05/20	S	FRE	--	E2	D1	L1	H	75









Renault

Renault













Renault Talisman Limousine nicht für Kfz. mit sensorgesteuerter Heckklappe (Fußsensor)	04/16--05/20	KIT		316 407 900 113		90	27.4	10.0	75	1850		im KIT enthalten 316 407 300 113	-05/20	S	FRE	--	E2	D1	L1	H	75
Renault Talisman Limousine nicht für Kfz. mit sensorgesteuerter Heckklappe (Fußsensor)	04/16-02/22			316 407 600 001		75	24.2	10.1	75	1850		316 407 300 113	-05/20	S	FRE	--	E2	D1	L1	H	75
Renault Trafic Kasten/Kombi inkl. Kugelplatte	05/01-09/14			314 364 600 001	→ 	60	21.0	12.3	85	2100		314 860 300 113 314 870 300 113	08/06-03/10 03/10-	S S	FRE FRE	-- --	-- --	D1 D1	L1 L1	H H	60 60
Renault Trafic Kasten/Kombi inkl. Kugelplatte	08/06-03/10	KIT		314 364 900 113		60	23.0	12.3	85	2100		im KIT enthalten 314 860 300 113	08/06-03/10	S	FRE	--	--	D1	L1	H	60
Renault Trafic Kasten/Kombi inkl. Kugelplatte	03/10-09/14	KIT		314 870 900 113		60	23.0	12.3	85	2100		im KIT enthalten 314 870 300 113	03/10-	S	FRE	--	--	D1	L1	H	60
Renault Twingo nicht für Modell "Sport" auch für Gordini R.S., jedoch ist ein sichtbarer Ausschnitt notwendig (anpassen)	06/07-14			316 326 600 001	→ 	60	17.0	4.2	65	500		300 210 300 113		--	A	--	E1	D1	L1	V	90

































Seat

Seat Alhambra inkl. Wärmeschutzblech auch für 4WD Stoßfängerträger nicht erforderlich	05/00-09/10		321 665 600 001			90	24.0	12.5	100	2500		321 458 300 113			S	FRE	--	E	D1	L1	H	60
		KIT 	321 665 900 113			90	26.0	12.5	100	2500		im KIT enthalten 321 458 300 113			S	FRE	--	E	D1	L1	H	60
Seat Alhambra	10/10-01/22		321 698 600 001				22.0	12.3	100	2500		321 600 300 113	-01/22		S	FRE	C	E	D	L1	V	105
		KIT 	321 698 900 113				24.0	12.3	100	2500		im KIT enthalten 321 600 300 113	-01/22		S	FRE	C	E	D	L1	V	105
Seat Alhambra Bitte Spoiler und Klappe für Stoßfängerausschnitt beim Seat- Händler bestellen.	10/10-01/22		321 700 600 001				22.0	12.3	100	2500		321 600 300 113	-01/22		S	FRE	C	E	D	L1	V	105
		KIT 	321 700 900 113				24.0	12.3	100	2500		im KIT enthalten 321 600 300 113	-01/22		S	FRE	C	E	D	L1	V	105
Seat Altea nicht für FR	06/04-12/15		344 043 600 001			60	18.0	9.3	100	1650		344 044 300 113			S	CAN	C	E	D1	L1	V	90
Seat Altea für Fzg. ohne Vorrüstung nicht für FR	06/04-12/15	KIT 	344 043 900 113			60	20.0	9.3	100	1650		im KIT enthalten 344 044 300 113			S	CAN	C	E	D1	L1	V	90
Seat Altea auch für FR Bitte Klappe für Stoßfängerausschnitt beim Seat- Händler bestellen, Art.-Nr. 5P0 803 595.	06/04-12/15		344 044 600 001			60	18.0	9.3	100	1650		344 044 300 113			S	CAN	C	E	D1	L1	V	90
		KIT 	344 044 900 113			60	19.5	9.3	100	1650		im KIT enthalten 344 044 300 113			S	CAN	C	E	D1	L1	V	90
Seat Altea XL + Freetrack	10/06-12/15		344 043 600 001			60	18.0	9.3	100	1650		344 044 300 113	ohne Vorrüstung		S	CAN	C	E	D1	L1	V	90
Seat Altea XL + Freetrack für Fzg. ohne Vorrüstung	10/06-12/15	KIT 	344 043 900 113			60	20.0	9.3	100	1650		im KIT enthalten 344 044 300 113	ohne Vorrüstung		S	CAN	C	E	D1	L1	V	90
Seat Altea XL + Freetrack Passende Klappe für Stoßfängerausschnitt nicht verfügbar.	10/06-12/15		344 048 600 001			60	17.5	9.3	100	1650		344 044 300 113	ohne Vorrüstung		S	CAN	C	E	D1	L1	V	90

Seat Altea XL + Freetrack für Fzg. ohne Vorrüstung Passende Klappe für Stoßfängerausschnitt nicht verfügbar.	10/06-12/15	KIT		344 048 900 113		60	19.5	9.3	100	1650		im KIT enthalten 344 044 300 113		ohne Vorrüstung	S	CAN	C	E	D1	L1	V	90
Seat Arona FR: sichtbarer Ausschnitt nicht für TGI	11/17-08/21			344 111 600 001		70	21.6	7.1	55	1200		344 110 300 113			S	CAN	C	E	D	L	V	60
Seat Arona KJ nicht für TGI	11/17-08/21			344 110 600 001		70	20.4	7.1	55	1200		344 110 300 113			S	CAN	C	E	D	L	V	60
		KIT		344 110 900 113		70	21.6	7.1	55	1200		im KIT enthalten 344 110 300 113			S	CAN	C	E	D	L	V	60
		KIT		344 111 900 113		70	22.8	7.1	55	1200		im KIT enthalten 344 110 300 113			S	CAN	C	E	D	L	V	60
Seat Arona FR KJ nicht für TGI	11/17-08/21			344 110 600 001		70	20.4	7.1	55	1200		344 110 300 113			S	CAN	C	E	D	L	V	60
Seat Arona FR KJ nicht für TGI	11/17-08/21			344 111 600 001		70	21.6	7.1	55	1200		344 110 300 113			S	CAN	C	E	D	L	V	60
		KIT		344 110 900 113		70	21.6	7.1	55	1200		im KIT enthalten 344 110 300 113			S	CAN	C	E	D	L	V	60
		KIT		344 111 900 113		70	22.8	7.1	55	1200		im KIT enthalten 344 110 300 113			S	CAN	C	E	D	L	V	60









Seat









Seat Ateca KH7 auch für FR	09/16-		344 124 600 001		60	17.7	12.3	150	2500	305 407 300 113	für Fzg. mit Vorrüstung	S	CAN	C	E	D	L	H	30
										305 408 300 107	→ für Fzg. ohne Vorrüstung	S	CAN	C	E	--	--	V	60
										305 408 300 113	für Fzg. ohne Vorrüstung	S	CAN	C	E	D	L	V	60
										305 438 300 113	inkl. WLC 2.0 für Fzg. ohne Vorrüstung	S	CAN	C	E	D	L1	V	90
										344 095 300 113	09/16- KH7 für Fzg. mit Vorrüstung und im Fahrzeug integriertem Anhänger-Steuergerät , für PR-Nr. 1M7	S	CAN	--	E	D	L	H	30
Seat Ateca KH7 für Fzg. ohne Vorrüstung auch für FR	09/16-	KIT 	344 121 900 113		60	16.0	12.3	150	2500	im KIT enthalten 305 438 300 113	inkl. WLC 2.0 für Fzg. ohne Vorrüstung	S	CAN	C	E	D	L1	V	90
										KIT 	344 124 900 113		60	19.6	12.3	150	2500	im KIT enthalten 305 438 300 113	inkl. WLC 2.0 für Fzg. ohne Vorrüstung
Seat Ateca KH7 auch für FR	09/16-		344 121 600 001		60	14.0	12.3	150	2500	305 407 300 113	für Fzg. mit Vorrüstung	S	CAN	C	E	D	L	H	30
										305 408 300 107	→ für Fzg. ohne Vorrüstung	S	CAN	C	E	--	--	V	60
										305 408 300 113	für Fzg. ohne Vorrüstung	S	CAN	C	E	D	L	V	60
										305 438 300 113	inkl. WLC 2.0 für Fzg. ohne Vorrüstung	S	CAN	C	E	D	L1	V	90
										344 095 300 113	09/16- KH7 für Fzg. mit Vorrüstung und im Fahrzeug integriertem Anhänger-Steuergerät , für PR-Nr. 1M7	S	CAN	--	E	D	L	H	30
Seat Ateca KH7 für Fzg. mit Vorrüstung auch für FR	09/16-	KIT 	344 071 900 113		60	15.5	12.3	150	2500	im KIT enthalten 305 407 300 113	für Fzg. mit Vorrüstung	S	CAN	C	E	D	L	H	30
										KIT 	344 072 900 113		60	19.2	12.3	150	2500	im KIT enthalten 305 407 300 113	für Fzg. mit Vorrüstung

Seat Exeo Limousine und ST/ Kombi	03/09-12/13			344 074 600 001		120	20.0	10.6	100	2000		305 210 300 113			S	CAN	C	E	D1	L1	V	105
		KIT		344 054 900 113		120	22.0	10.6	100	2000		im KIT enthalten 305 210 300 113			S	CAN	C	E	D1	L1	V	105
Seat Ibiza ST/Kombi / 3-/5-Türer Bitte Klappe für Stoßfängerausschnitt beim Seat- Händler bestellen.	07/08--07/15	KIT		344 060 900 113		90	24.0	7.7	75	1400		im KIT enthalten 317 420 300 113	-07/15		S	CAN	C	E	D1	L1	V	105
Seat Ibiza ST/Kombi / 3-/5-Türer	07/08-06/17			344 059 600 001		90	17.5	8.3	75	1400		317 114 300 113	07/15-06/17		S	CAN	C	E	D1	L1	V	90
		KIT		344 059 900 113		90	18.5	8.3	75	1400		317 420 300 113	-07/15		S	CAN	C	E	D1	L1	V	105
Seat Ibiza ST/Kombi / 3-/5-Türer Bitte Klappe für Stoßfängerausschnitt beim Seat- Händler bestellen.	07/08-06/17			344 079 600 001		90	22.0	7.7	75	1400		317 114 300 113	07/15-06/17		S	CAN	C	E	D1	L1	V	90
		KIT		344 079 900 113		90	19.5	7.7	75	1400		317 420 300 113	-07/15		S	CAN	C	E	D1	L1	V	105
Seat Ibiza ST/Kombi / 3-/5-Türer	07/15-06/17	KIT		344 059 900 113		90	18.5	8.3	75	1400		im KIT enthalten 317 114 300 113	07/15-06/17		S	CAN	C	E	D1	L1	V	90
Seat Ibiza ST/Kombi / 3-/5-Türer Bitte Klappe für Stoßfängerausschnitt beim Seat- Händler bestellen.	07/15-06/17			344 079 900 113		90	19.5	7.7	75	1400		im KIT enthalten 317 114 300 113	07/15-06/17		S	CAN	C	E	D1	L1	V	90
		KIT		344 122 900 113		60	19.0	7.5	91	1270		im KIT enthalten 344 110 300 113			S	CAN	C	E	D	L	V	60
Seat Ibiza V (KJ1) nicht für TGI	02/17-			344 122 600 001		60	17.0	7.5	91	1270		344 110 300 113			S	CAN	C	E	D	L	V	60
		KIT		344 123 900 113		60	20.0	7.5	91	1270		im KIT enthalten 344 110 300 113			S	CAN	C	E	D	L	V	60
Seat Ibiza V (KJ1) nicht für TGI	02/17-			344 123 600 001		60	18.0	7.5	91	1270		344 110 300 113			S	CAN	C	E	D	L	V	60
		KIT		305 223 600 001		120	16.8	8.9	75	1650												
Seat Leon 1M1	11/99-06/06			305 223 600 001		120	16.8	8.9	75	1650												
Seat Leon nicht für FR + FRV Formula Race, nicht für Cupra	09/05-12/12			344 043 600 001		60	18.0	9.3	100	1650		321 600 300 113			S	FRE	C	E	D	L1	V	105

Seat











Seat





















Seat Leon auch für FR nicht für FRV Formula Race, Cupra Bitte Klappe für Stoßfängerausschnitt beim Seat- Händler bestellen, Art.-Nr.-05/09: 5P0 803 595, 05/09-: 1P0 092 595.	09/05-12/12			344 044 600 001		60	18.0	9.3	100	1650		321 600 300 113			S	FRE	C	E	D	L1	V	105
Seat Leon III (5F) für Fzg. ohne Vorrüstung 5-Türer Seat Leon SC, 3-Türer Seat Leon ST, Kombi auch für FR nicht für Cupra	11/12-06/14	KIT		317 131 900 113		60	21.0	10.3	85	2000		im KIT enthalten 305 406 300 113		-06/14 für Fzg. ohne Vorrüstung	S	CAN	C	E	D	L1	V	150
Seat Leon III (5F) für Fzg. ohne Vorrüstung 5-Türer Seat Leon SC, 3-Türer Seat Leon ST, Kombi auch für FR nicht für Cupra Bitte Klappe für Stoßfängerausschnitt beim Seat- Händler bestellen.	11/12-06/14	KIT		317 132 900 113		60	21.0	10.3	85	2000		im KIT enthalten 305 406 300 113		-06/14 für Fzg. ohne Vorrüstung	S	CAN	C	E	D	L1	V	150
Seat Leon III (5F) 5-Türer Seat Leon SC, 3-Türer Seat Leon ST, Kombi auch für X-Perience 06/14- auch für FR nicht für Cupra	11/12-04/20			317 131 600 001		60	19.0	10.3	85	2000		305 403 300 113		-06/14 für Fzg. mit Vorrüstung	S	CAN	C	E	D	L1	H	45
												305 406 300 113		-06/14 für Fzg. ohne Vorrüstung	S	CAN	C	E	D	L1	V	150
												305 407 300 113		06/14-04/20 für Fzg. mit Vorrüstung	S	CAN	C	E	D	L	H	30
												305 408 300 107	→	06/14-04/20 für Fzg. ohne Vorrüstung	S	CAN	C	E	--	--	V	60
												305 408 300 113		06/14-04/20 für Fzg. ohne Vorrüstung	S	CAN	C	E	D	L	V	60
												344 095 300 113		06/14-04/20 für Fzg. mit Vorrüstung und im Fahrzeug integriertem Anhäng- Steuergerät	S	CAN	--	E	D	L	H	30

Seat Leon III (5F) 5-Türer Seat Leon SC, 3-Türer Seat Leon ST, Kombi auch für X-Perience 06/14- auch für FR nicht für Cupra Bitte Klappe für Stoßfängerausschnitt beim Seat- Händler bestellen.	11/12-04/20		317 132 600 001		60	19.0	10.3	85	2000	305 403 300 113	-06/14 für Fzg. mit Vorrüstung	S	CAN	C	E	D	L1	H	45	
										305 406 300 113	-06/14 für Fzg. ohne Vorrüstung	S	CAN	C	E	D	L1	V	150	
										305 407 300 113	06/14-04/20 für Fzg. mit Vorrüstung	S	CAN	C	E	D	L	H	30	
										305 408 300 107 →	06/14-04/20 für Fzg. ohne Vorrüstung	S	CAN	C	E	--	--	V	60	
										305 408 300 113	06/14-04/20 für Fzg. ohne Vorrüstung	S	CAN	C	E	D	L	V	60	
									344 095 300 113	06/14-04/20 für Fzg. mit Vorrüstung und im Fahrzeug integriertem Anhäng- Steuergerät	S	CAN	--	E	D	L	H	30		
Seat Leon III (5F) für Fzg. ohne Vorrüstung 5-Türer Seat Leon SC, 3-Türer Seat Leon ST, Kombi auch für X-Perience auch für FR nicht für Cupra	11/12-04/20	KIT		305 418 900 113		60	20.9	10.3	85	2000	im KIT enthalten 305 438 300 113	inkl. WLC 2.0 für Fzg. ohne Vorrüstung	S	CAN	C	E	D	L1	V	90
Seat Leon III (5F) für Fzg. ohne Vorrüstung 5-Türer Seat Leon SC, 3-Türer Seat Leon ST, Kombi auch für X-Perience auch für FR nicht für Cupra Bitte Klappe für Stoßfängerausschnitt beim Seat- Händler bestellen.	11/12-04/20	KIT		305 419 900 113		60	20.9	10.3	85	2000	im KIT enthalten 305 438 300 113	inkl. WLC 2.0 für Fzg. ohne Vorrüstung	S	CAN	C	E	D	L1	V	90
Seat Leon III (5F) für Fzg. mit Vorrüstung 5-Türer Seat Leon SC, 3-Türer Seat Leon ST, Kombi auch für X-Perience auch für FR nicht für Cupra	06/14-04/20	KIT		317 154 900 113		60	20.5	10.3	85	2000	im KIT enthalten 305 407 300 113	06/14-04/20 für Fzg. mit Vorrüstung	S	CAN	C	E	D	L	H	30

















Seat















Seat

Seat Leon III (5F) für Fzg. mit Vorrüstung 5-Türer Seat Leon SC, 3-Türer Seat Leon ST, Kombi auch für X-Perience auch für FR nicht für Cupra Bitte Klappe für Stoßfängerausschnitt beim Seat-Händler bestellen.	06/14-04/20	KIT		317 155 900 113		60	20.5	10.3	85	2000		im KIT enthalten 305 407 300 113	06/14-04/20 für Fzg. mit Vorrüstung	S	CAN	C	E	D	L	H	30
Seat Leon III (5F) für Fzg. ohne Vorrüstung 5-Türer Seat Leon SC, 3-Türer Seat Leon ST, Kombi auch für X-Perience auch für FR nicht für Cupra	06/14-04/20	KIT		305 408 900 113		60	19.0	10.3	85	2000		im KIT enthalten 305 408 300 113	für Fzg. ohne Vorrüstung	S	CAN	C	E	D	L	V	60
Seat Leon III (5F) für Fzg. ohne Vorrüstung 5-Türer Seat Leon SC, 3-Türer Seat Leon ST, Kombi auch für X-Perience auch für FR nicht für Cupra Bitte Klappe für Stoßfängerausschnitt beim Seat-Händler bestellen.	06/14-04/20	KIT		305 409 900 113		60	21.0	10.3	85	2000		im KIT enthalten 305 408 300 113	für Fzg. ohne Vorrüstung	S	CAN	C	E	D	L	V	60
Seat Leon IV (KL1) für Fzg. ohne Vorrüstung auch für Hybrid	04/20-	KIT		322 080 900 113		60	21.0	10.3	85	2000		im KIT enthalten 322 080 300 113	für Fzg. ohne Vorrüstung	S	CAN	C	E	D	L	V	120
Seat Leon IV (KL1) auch für Hybrid	04/20-			317 131 600 001		60	19.0	10.3	85	2000		322 080 300 113 344 095 300 113	für Fzg. ohne Vorrüstung 04/20- KL1 für Fzg. mit Vorrüstung und im Fahrzeug integriertem Anhänger-Steuergerät , für PR-Nr. 1M7	S	CAN	C	E	D	L	V	120
														S	CAN	--	E	D	L	H	30

Seat Leon IV KL1 auch für Hybrid	04/20-			305 605 600 001		60	19.4	9.0	109	2100		322 080 300 113	für Fzg. ohne Vorrüstung	S	CAN	C	E	D	L	V	120
				305 606 600 001		60	21.4	9.0	109	2100		344 095 300 113	04/20- KL1 für Fzg. mit Vorrüstung und im Fahrzeug integriertem Anhänger-Steuergerät , für PR-Nr. 1M7	S	CAN	--	E	D	L	H	30
Seat Leon IV KL1 für Fzg. ohne Vorrüstung auch für Hybrid	04/20-	KIT		305 605 900 113		60	21.4	9.0	109	2100		im KIT enthalten 322 080 300 113	für Fzg. ohne Vorrüstung	S	CAN	C	E	D	L	V	120
				305 606 900 113		60	23.4	9.0	109	2100		im KIT enthalten 322 080 300 113	für Fzg. ohne Vorrüstung	S	CAN	C	E	D	L	V	120
Seat Leon IV Sportstourer KL8 auch für Hybrid	03/20-			305 605 600 001		60	19.4	9.0	109	2100		322 080 300 113	für Fzg. ohne Vorrüstung	S	CAN	C	E	D	L	V	120
				305 606 600 001		60	21.4	9.0	109	2100		344 095 300 113	03/20- KL8 für Fzg. mit Vorrüstung und im Fahrzeug integriertem Anhänger-Steuergerät , für PR-Nr. 1M7	S	CAN	--	E	D	L	H	30
Seat Leon IV Sportstourer KL8 auch für Hybrid AUFNAHMEROHR FÜR KUGELSTANGE SICHTBAR	03/20-			305 606 600 001		60	21.4	9.0	109	2100		322 080 300 113	für Fzg. ohne Vorrüstung	S	CAN	C	E	D	L	V	120
				305 606 600 001		60	21.4	9.0	109	2100		344 095 300 113	03/20- KL8 für Fzg. mit Vorrüstung und im Fahrzeug integriertem Anhänger-Steuergerät , für PR-Nr. 1M7	S	CAN	--	E	D	L	H	30
Seat Leon IV Sportstourer KL8 für Fzg. ohne Vorrüstung auch für Hybrid AUFNAHMEROHR FÜR KUGELSTANGE SICHTBAR	03/20-	KIT		305 605 900 113		60	21.4	9.0	109	2100		im KIT enthalten 322 080 300 113	für Fzg. ohne Vorrüstung	S	CAN	C	E	D	L	V	120
				305 606 900 113		60	23.4	9.0	109	2100		im KIT enthalten 322 080 300 113	für Fzg. ohne Vorrüstung	S	CAN	C	E	D	L	V	120

























Seat

Seat Tarraco KN2	09/18-		344 121 600 001		60	14.0	12.3	150	2500	305 408 300 107	→	für Fzg. ohne Vorrüstung	S	CAN	C	E	--	--	V	60
										305 408 300 113		für Fzg. ohne Vorrüstung	S	CAN	C	E	D	L	V	60
										344 095 300 113		09/18- KN2 für Fzg. mit Vorrüstung und im Fahrzeug integriertem Anhänger-Steuergerät , für PR-Nr. 1M7	S	CAN	--	E	D	L	H	30
Seat Tarraco KN2 für Fzg. ohne Vorrüstung	09/18-	KIT		344 121 900 113		60	16.0	12.3	150	2500	im KIT enthalten 305 438 300 113	inkl. WLC 2.0 für Fzg. ohne Vorrüstung	S	CAN	C	E	D	L1	V	90
Seat Tarraco KN2 für Fzg. mit Vorrüstung	09/18-	KIT		344 071 900 113		60	15.5	12.3	150	2500	im KIT enthalten 305 407 300 113	für Fzg. mit Vorrüstung								30
		KIT		344 070 900 113		60	18.7	12.3	150	2500	im KIT enthalten 305 407 300 113	für Fzg. mit Vorrüstung								
Seat Tarraco KN2	09/18-		344 120 600 001		60	16.6	12.3	150	2500	305 408 300 107	→	für Fzg. ohne Vorrüstung	S	CAN	C	E	--	--	V	60
										305 408 300 113		für Fzg. ohne Vorrüstung	S	CAN	C	E	D	L	V	60
										344 095 300 113		09/18- KN2 für Fzg. mit Vorrüstung und im Fahrzeug integriertem Anhänger-Steuergerät , für PR-Nr. 1M7	S	CAN	--	E	D	L	H	30
Seat Tarraco KN2 für Fzg. ohne Vorrüstung	09/18-	KIT		344 120 900 113		60	18.5	12.3	150	2500	im KIT enthalten 305 438 300 113	inkl. WLC 2.0 für Fzg. ohne Vorrüstung	S	CAN	C	E	D	L1	V	90
Seat Toledo	03/12--07/15	KIT		317 129 900 113		45	23.0	8.5	50	1200	im KIT enthalten 317 420 300 113	-07/15	S	CAN	C	E	D1	L1	V	105
		KIT		317 130 900 113		45	23.0	8.5	50	1200	im KIT enthalten 317 420 300 113	-07/15	S	CAN	C	E	D1	L1	V	105

Seat Toledo Typ 6L, 5P, 1P	11/04-03/12			344 043 600 001		60	18.0	9.3	100	1650		344 044 300 113				S	CAN	C	E	D1	L1	V	90
				344 044 600 001		60	18.0	9.3	100	1650													
	KIT		344 044 900 113		60	19.5	9.3	100	1650		im KIT enthalten 344 044 300 113				S	CAN	C	E	D1	L1	V	90	
Seat Toledo Typ 6L, 5P, 1P für Fzg. ohne Vorrüstung	11/04-03/12	KIT		344 043 900 113		60	20.0	9.3	100	1650		im KIT enthalten 344 044 300 113				S	CAN	C	E	D1	L1	V	90
Seat Toledo	03/12-04/19			317 130 600 001		45	21.5	8.5	50	1200		317 114 300 113	07/15-			S	CAN	C	E	D1	L1	V	90
				317 420 300 113								317 420 300 113	-07/15			S	CAN	C	E	D1	L1	V	105
Seat Toledo	07/15-04/19	KIT		317 120 900 113		45	25.0	8.5	50	1200		im KIT enthalten 317 114 300 113	07/15-			S	CAN	C	E	D1	L1	V	90

























Seat



















Skoda

Skoda Enyaq IV 5AC	10/20-		317 184 600 001		60	18.2	9.1	100	1400		322 090 300 113	10/20- für Fzg. ohne Vorrüstung	S	CAN	C	E	D	L	V	75
Skoda Fabia I Combi/ Stufenheck nicht für GT, auch für Praktik -07	11/00-12/07		317 059 600 001		60	16.5	7.0	50	1200		317 043 300 113		S	FRE	--	E	D1	L1	H	45
		KIT 	317 059 900 113		60	18.5	7.0	50	1200		im KIT enthalten 317 043 300 113		S	FRE	--	E	D1	L1	H	45
Skoda Fabia II Combi nicht für RS	01/08-05/10	KIT 	317 085 900 113		40	16.5	7.2	86	1200		im KIT enthalten 317 400 300 113	-05/10	S	C2	C	E	D1	--	H	45
Skoda Fabia II Combi nicht für RS Bitte Abdeckklappe für Stoßfängerausschnitt beim Skoda-Händler bestellen.	01/08-05/10	KIT 	317 086 900 113		40	16.5	7.2	86	1200		im KIT enthalten 317 400 300 113	-05/10	S	C2	C	E	D1	--	H	45
Skoda Fabia II Combi nicht für RS	01/08-12/14		317 113 600 001		40	14.5	7.2	86	1200		317 400 300 113	-05/10	S	C2	C	E	D1	--	H	45
		317 420 300 113	05/10-	S	CAN	C	E	D1	L1	V	105									
Skoda Fabia II Combi nicht für RS Bitte Abdeckklappe für Stoßfängerausschnitt beim Skoda-Händler bestellen.	01/08-12/14		317 114 600 001		40	15.0	7.2	86	1200		317 400 300 113	-05/10	S	C2	C	E	D1	--	H	45
		317 420 300 113	05/10-	S	CAN	C	E	D1	L1	V	105									
Skoda Fabia II Combi nicht für RS	05/10-12/14	KIT 	317 250 900 113		40	16.5	7.2	86	1200		im KIT enthalten 317 420 300 113	05/10-	S	CAN	C	E	D1	L1	V	105
Skoda Fabia II Combi nicht für RS Bitte Abdeckklappe für Stoßfängerausschnitt beim Skoda-Händler bestellen.	05/10-12/14		317 251 900 113		40	16.5	7.2	86	1200		im KIT enthalten 317 420 300 113	05/10-	S	CAN	C	E	D1	L1	V	105
		317 420 300 113	05/10-	S	CAN	C	E	D1	L1	V	105									
Skoda Fabia II Schrägheck nicht für RS + Monte Carlo	06/07-05/10	KIT 	317 085 900 113		40	16.5	7.2	86	1200		im KIT enthalten 317 400 300 113	-05/10	S	C2	C	E	D1	--	H	45
Skoda Fabia II Schrägheck nicht für RS + Monte Carlo Bitte Abdeckklappe für Stoßfängerausschnitt beim Skoda-Händler bestellen.	06/07-05/10		317 086 900 113		40	16.5	7.2	86	1200		im KIT enthalten 317 400 300 113	-05/10	S	C2	C	E	D1	--	H	45
		317 400 300 113	-05/10	S	C2	C	E	D1	--	H	45									
Skoda Fabia II Schrägheck nicht für RS + Monte Carlo	06/07-10/14		317 113 600 001		40	14.5	7.2	86	1200		317 400 300 113	-05/10	S	C2	C	E	D1	--	H	45
		317 420 300 113	05/10-	S	CAN	C	E	D1	L1	V	105									

Skoda Fabia II Schrägheck nicht für RS + Monte Carlo Bitte Abdeckklappe für Stoßfängerausschnitt beim Skoda-Händler bestellen.	06/07-10/14			317 114 600 001		40	15.0	7.2	86	1200		317 400 300 113	-05/10	S	C2	C	E	D1	--	H	45
												317 420 300 113	05/10-	S	CAN	C	E	D1	L1	V	105
Skoda Fabia II Schrägheck nicht für RS + Monte Carlo	05/10-10/14	KIT		317 250 900 113		40	16.5	7.2	86	1200		im KIT enthalten 317 420 300 113	05/10-	S	CAN	C	E	D1	L1	V	105
Skoda Fabia II Schrägheck nicht für RS + Monte Carlo Bitte Abdeckklappe für Stoßfängerausschnitt beim Skoda-Händler bestellen.	05/10-10/14	KIT		317 251 900 113		40	16.5	7.2	86	1200		im KIT enthalten 317 420 300 113	05/10-	S	CAN	C	E	D1	L1	V	105
Skoda Fabia III Combi auch für Facelift 2019- Achtung: Aufnahmerohr und Steckdosenhalter sichtbar	01/15-04/22			317 114 600 001		40	15.0	7.2	86	1200		317 114 300 113	01/15-04/22	S	CAN	C	E	D1	L1	V	90
		KIT		317 114 900 113		40	18.0	7.2	86	1200		im KIT enthalten 317 114 300 113	01/15-04/22	S	CAN	C	E	D1	L1	V	90
Skoda Fabia III Combi	01/15-04/22			317 113 600 001		40	14.5	7.2	86	1200		317 114 300 113	01/15-04/22	S	CAN	C	E	D1	L1	V	90
		KIT		317 113 900 113		40	17.5	7.2	86	1200		im KIT enthalten 317 114 300 113	01/15-04/22	S	CAN	C	E	D1	L1	V	90
Skoda Fabia III Schrägheck (542)	11/14-05/21			317 113 600 001		40	14.5	7.2	86	1200		317 114 300 113	11/14-05/21	S	CAN	C	E	D1	L1	V	90
		KIT		317 113 900 113		40	17.5	7.2	86	1200		im KIT enthalten 317 114 300 113	11/14-05/21	S	CAN	C	E	D1	L1	V	90
Skoda Fabia III Schrägheck (542) auch für Facelift 2019- Achtung: Aufnahmerohr und Steckdosenhalter sichtbar	11/14-05/21			317 114 600 001		40	15.0	7.2	86	1200		317 114 300 113	11/14-05/21	S	CAN	C	E	D1	L1	V	90
		KIT		317 114 900 113		40	18.0	7.2	86	1200		im KIT enthalten 317 114 300 113	11/14-05/21	S	CAN	C	E	D1	L1	V	90

























Skoda















Skoda Fabia IV Schrägheck PJ3 nicht für Monte Carlo	06/21-			317 174 600 001		60	18.3	6.6	80	1100		344 110 300 113	06/21-	S	CAN	C	E	D	L	V	60
		KIT		317 173 900 113		60	18.0	6.6	80	1100		im KIT enthalten 344 110 300 113	06/21-	S	CAN	C	E	D	L	V	60
		KIT		317 174 900 113		60	20.3	6.6	80	1100		im KIT enthalten 344 110 300 113	06/21-	S	CAN	C	E	D	L	V	60
Skoda Fabia IV Schrägheck PJ3 nicht für Monte Carlo	06/21-			317 173 600 001		60	16.0	6.6	80	1100		344 110 300 113	06/21-	S	CAN	C	E	D	L	V	60
Skoda Kamiq nicht für TGI	07/19-			317 171 600 001		60	19.3	7.7	89	2100		344 110 300 113		S	CAN	C	E	D	L	V	60
				317 172 600 001		60	21.4	11.2	130	2100											
		KIT		317 171 900 113		60	21.3	7.7	89	2100		im KIT enthalten 344 110 300 113		S	CAN	C	E	D	L	V	60
Skoda Kamiq nicht für TGI	07/19-	KIT		317 172 900 113		60	23.4	11.2	130	2100		im KIT enthalten 344 110 300 113		S	CAN	C	E	D	L	V	60
Skoda Karoq KU7	11/17-11/21			344 121 600 001		60	14.0	12.3	150	2500		305 407 300 113	für Fzg. mit Vorrüstung	S	CAN	C	E	D	L	H	30
												305 408 300 107	→ für Fzg. ohne Vorrüstung	S	CAN	C	E	--	--	V	60
													305 408 300 113	für Fzg. ohne Vorrüstung	S	CAN	C	E	D	L	V
Skoda Karoq KU7 für Fzg. ohne Vorrüstung	11/17-11/21	KIT		344 121 900 113		60	16.0	12.3	150	2500		im KIT enthalten 305 438 300 113	inkl. WLC 2.0 für Fzg. ohne Vorrüstung	S	CAN	C	E	D	L1	V	90
Skoda Karoq KU7 für Fzg. mit Vorrüstung	11/17-11/21	KIT		344 071 900 113		60	15.5	12.3	150	2500		im KIT enthalten 305 407 300 113	für Fzg. mit Vorrüstung	S	CAN	C	E	D	L	H	30
		KIT		344 072 900 113		60	19.2	12.3	150	2500		im KIT enthalten 305 407 300 113	für Fzg. mit Vorrüstung	S	CAN	C	E	D	L	H	30

Skoda Karoq KU7	11/17-11/21		344 124 600 001		60	17.7	12.3	150	2500	305 407 300 113		für Fzg. mit Vorrüstung	S	CAN	C	E	D	L	H	30	
										305 408 300 107		für Fzg. ohne Vorrüstung	S	CAN	C	E	--	--	V	60	
										305 408 300 113		für Fzg. ohne Vorrüstung	S	CAN	C	E	D	L	V	60	
										305 438 300 113		inkl. WLC 2.0 für Fzg. ohne Vorrüstung	S	CAN	C	E	D	L1	V	90	
Skoda Karoq KU7 für Fzg. ohne Vorrüstung	11/17-11/21	KIT		344 124 900 113		60	19.6	12.3	150	2500	im KIT enthalten 305 438 300 113		inkl. WLC 2.0 für Fzg. ohne Vorrüstung	S	CAN	C	E	D	L1	V	90
Skoda Kodiaq NS7 150 BHP Diesel Manual 4x4 7-Sitzer ist nicht für Anhängerbetrieb freigegeben. auch für Facelift 2021-	10/16-		344 121 600 001		60	14.0	12.3	150	2500	305 408 300 107		für Fzg. ohne Vorrüstung	S	CAN	C	E	--	--	V	60	
										305 408 300 113		für Fzg. ohne Vorrüstung	S	CAN	C	E	D	L	V	60	
Skoda Kodiaq NS7 für Fzg. ohne Vorrüstung 150 BHP Diesel Manual 4x4 7-Sitzer ist nicht für Anhängerbetrieb freigegeben. auch für Facelift 2021-	10/16-	KIT		344 121 900 113		60	16.0	12.3	150	2500	im KIT enthalten 305 438 300 113		inkl. WLC 2.0 für Fzg. ohne Vorrüstung	S	CAN	C	E	D	L1	V	90
Skoda Kodiaq NS7 für Fzg. mit Vorrüstung 150 BHP Diesel Manual 4x4 7-Sitzer ist nicht für Anhängerbetrieb freigegeben. auch für Facelift 2021-	10/16-	KIT		344 071 900 113		60	15.5	12.3	150	2500	im KIT enthalten 305 407 300 113		für Fzg. mit Vorrüstung	S	CAN	C	E	D	L	H	30
											KIT		344 070 900 113		60	18.7	12.3	150	2500	im KIT enthalten 305 407 300 113	
Skoda Kodiaq NS7 150 BHP Diesel Manual 4WD 7-Sitzer ist nicht für Anhängerbetrieb freigegeben auch für Facelift 2021-	10/16-		344 120 600 001		60	16.6	12.3	150	2500	305 408 300 107		für Fzg. ohne Vorrüstung	S	CAN	C	E	--	--	V	60	
										305 408 300 113		für Fzg. ohne Vorrüstung	S	CAN	C	E	D	L	V	60	
Skoda Kodiaq NS7 für Fzg. ohne Vorrüstung 150 BHP Diesel Manual 4WD 7-Sitzer ist nicht für Anhängerbetrieb freigegeben auch für Facelift 2021-	10/16-	KIT		344 120 900 113		60	18.5	12.3	150	2500	im KIT enthalten 305 438 300 113		inkl. WLC 2.0 für Fzg. ohne Vorrüstung	S	CAN	C	E	D	L1	V	90





















Skoda





























Skoda

Skoda Octavia I Limousine/Combi Typ 1U nicht für Allradfahrzeuge, auch für RS Bei Anhängelasten ab 1400 kg bitte unbedingt Hinweise in der Betriebsanleitung des Fahrzeugs beachten!	12/96-01/05			305 223 600 001		120	16.8	8.9	75	1650		317 015 300 113			S	FRE	--	E	D1	L1	H	45	
		KIT		317 016 900 113		90	18.2	8.4	60	1500		im KIT enthalten 317 015 300 113			S	FRE	--	E	D1	L1	H	45	
Skoda Octavia II Combi 1Z / 3T auch für 4 x 4, RS und Scout Facelift 11/08-: kein Ausschnitt erforderlich	01/05-12/13			317 104 600 001		40	18.0	10.6	100	2000		321 600 300 113			S	FRE	C	E	D	L1	V	105	
				317 102 600 001		40	19.0	10.6	100	2000													
		KIT		317 104 900 113		40	20.0	10.6	100	2000		im KIT enthalten 321 600 300 113			S	FRE	C	E	D	L1	V	105	
		KIT		317 102 900 113		40	21.0	10.6	100	2000		im KIT enthalten 321 600 300 113			S	FRE	C	E	D	L1	V	105	
Skoda Octavia II Limousine 1Z / 3T auch für 4 x 4, RS und Scout Facelift 11/08-: kein Ausschnitt erforderlich	01/05-12/13			317 104 600 001		40	18.0	10.6	100	2000		321 600 300 113			S	FRE	C	E	D	L1	V	105	
				317 102 600 001		40	19.0	10.6	100	2000													
		KIT		317 104 900 113		40	20.0	10.6	100	2000		im KIT enthalten 321 600 300 113			S	FRE	C	E	D	L1	V	105	
		KIT		317 102 900 113		40	21.0	10.6	100	2000		im KIT enthalten 321 600 300 113			S	FRE	C	E	D	L1	V	105	
Skoda Octavia III (5E) für Fzg. ohne Vorrüstung Limousine und Combi auch für RS und Scout auch für Fzg. mit Gasbetrieb	02/13-06/14	KIT		317 132 900 113		60	21.0	10.3	85	2000		im KIT enthalten 305 406 300 113		-06/14 für Fzg. ohne Vorrüstung	S	CAN	C	E	D	L1	V	150	
Skoda Octavia III (5E) Limousine und Combi für Fzg. ohne Vorrüstung auch für RS und Scout auch für Fzg. mit Gasbetrieb	02/13-06/14	KIT		317 131 900 113		60	21.0	10.3	85	2000		im KIT enthalten 305 406 300 113		-06/14 für Fzg. ohne Vorrüstung	S	CAN	C	E	D	L1	V	150	

Skoda Octavia III (5E) Limousine und Combi auch für RS und Scout auch für Fzg. mit Gasbetrieb	02/13-01/20		317 131 600 001		60	19.0	10.3	85	2000	305 403 300 113	-06/14 für Fzg. mit Vorrüstung	S	CAN	C	E	D	L1	H	45	
			317 132 600 001		60	19.0	10.3	85	2000	305 406 300 113	-06/14 für Fzg. ohne Vorrüstung	S	CAN	C	E	D	L1	V	150	
										305 407 300 113	06/14-01/20 für Fzg. mit Vorrüstung	S	CAN	C	E	D	L	H	30	
										305 408 300 107	→ 06/14-01/20 für Fzg. ohne Vorrüstung	S	CAN	C	E	--	--	V	60	
										305 408 300 113	06/14-01/20 für Fzg. ohne Vorrüstung	S	CAN	C	E	D	L	V	60	
Skoda Octavia III (5E) für Fzg. ohne Vorrüstung Limousine und Combi auch für RS und Scout auch für Fzg. mit Gasbetrieb	02/13-01/20	KIT		305 418 900 113		60	20.9	10.3	85	2000	im KIT enthalten 305 438 300 113	inkl. WLC 2.0 für Fzg. ohne Vorrüstung	S	CAN	C	E	D	L1	V	90
				305 419 900 113		60	20.9	10.3	85	2000	im KIT enthalten 305 438 300 113	inkl. WLC 2.0 für Fzg. ohne Vorrüstung	S	CAN	C	E	D	L1	V	90
Skoda Octavia III (5E) für Fzg. ohne Vorrüstung Limousine und Combi auch für RS und Scout auch für Fzg. mit Gasbetrieb	06/14-01/20	KIT		305 408 900 113		60	19.0	10.3	85	2000	im KIT enthalten 305 408 300 113	06/14-01/20 für Fzg. ohne Vorrüstung	S	CAN	C	E	D	L	V	60
				305 409 900 113		60	21.0	10.3	85	2000	im KIT enthalten 305 408 300 113	06/14-01/20 für Fzg. ohne Vorrüstung	S	CAN	C	E	D	L	V	60
Skoda Octavia III (5E) für Fzg. mit Vorrüstung Limousine und Combi auch für RS und Scout auch für Fzg. mit Gasbetrieb	06/14-01/20	KIT		317 155 900 113		60	20.5	10.3	85	2000	im KIT enthalten 305 407 300 113	06/14-01/20 für Fzg. mit Vorrüstung	S	CAN	C	E	D	L	H	30
Skoda Octavia III (5E) für Fzg. mit Vorrüstung Limousine und Combi auch für RS und Scout auch für Fzg. mit Gasbetrieb	06/14-01/20	KIT		317 154 900 113		60	20.5	10.3	85	2000	im KIT enthalten 305 407 300 113	06/14-01/20 für Fzg. mit Vorrüstung	S	CAN	C	E	D	L	H	30

























Skoda























Skoda Octavia IV Combi (NX5) für Fzg. ohne Vorrüstung auch für AdBlue Bei Fzg. ohne AHK-Vorbereitung bitte Original-Spoiler beim Fahrzeughändler bestellen. Bitte Halter für Antennenverstärker separat bestellen: 917131631001	01/20-	KIT		322 080 900 113		60	21.0	10.3	85	2000		im KIT enthalten 322 080 300 113	für Fzg. ohne Vorrüstung	S	CAN	C	E	D	L	V	120
		KIT		322 081 900 113		60	21.0	10.3	85	2000		im KIT enthalten 322 080 300 113	für Fzg. ohne Vorrüstung	S	CAN	C	E	D	L	V	120
Skoda Octavia IV Combi (NX5) auch für AdBlue Bei Fzg. ohne AHK-Vorbereitung bitte Original-Spoiler beim Fahrzeughändler bestellen. Bitte Halter für Antennenverstärker separat bestellen: 917131631001	01/20-			317 131 600 001		60	19.0	10.3	85	2000		322 080 300 113	für Fzg. ohne Vorrüstung	S	CAN	C	E	D	L	V	120
				317 132 600 001		60	19.0	10.3	85	2000		322 081 300 113	für Fzg. mit Vorrüstung	S	CAN	C	E	D	L	H	45
Skoda Octavia IV Combi (NX5) auch für AdBlue auch für Hybrid Bei Fzg. ohne AHK-Vorbereitung bitte Original-Spoiler beim Fahrzeughändler bestellen.	01/20-			322 093 600 001		60	17.7	12.3	150	2500		322 080 300 113	für Fzg. ohne Vorrüstung	S	CAN	C	E	D	L	V	120
				322 094 600 001		60	17.7	12.3	150	2500		322 081 300 113	für Fzg. mit Vorrüstung	S	CAN	C	E	D	L	H	45
Skoda Octavia IV Combi (NX5) für Fzg. ohne Vorrüstung auch für AdBlue auch für Hybrid Bei Fzg. ohne AHK-Vorbereitung bitte Original-Spoiler beim Fahrzeughändler bestellen.	01/20-	KIT		322 093 900 113		60	19.6	12.3	150	2500		im KIT enthalten 322 080 300 113	für Fzg. ohne Vorrüstung	S	CAN	C	E	D	L	V	120
		KIT		322 094 900 113		60	19.6	12.3	150	2500		im KIT enthalten 322 080 300 113	für Fzg. ohne Vorrüstung	S	CAN	C	E	D	L	V	120
Skoda Octavia IV Limousine (NX3) für Fzg. ohne Vorrüstung auch für AdBlue Bei Fzg. ohne AHK-Vorbereitung bitte Original-Spoiler beim Fahrzeughändler bestellen. Bitte Halter für Antennenverstärker separat bestellen: 917131631001	01/20-	KIT		322 080 900 113		60	21.0	10.3	85	2000		im KIT enthalten 322 080 300 113	für Fzg. ohne Vorrüstung	S	CAN	C	E	D	L	V	120
Skoda Octavia IV Limousine (NX3) auch für AdBlue Bei Fzg. ohne AHK-Vorbereitung bitte Original-Spoiler beim Fahrzeughändler bestellen. Bitte Halter für Antennenverstärker separat bestellen: 917131631001	01/20-			317 131 600 001		60	19.0	10.3	85	2000		322 080 300 113	für Fzg. ohne Vorrüstung	S	CAN	C	E	D	L	V	120
												322 081 300 113	für Fzg. mit Vorrüstung	S	CAN	C	E	D	L	H	45

Skoda Octavia IV Limousine (NX3) auch für AdBlue auch für Hybrid Bei Fzg. ohne AHK-Vorbereitung bitte Original-Spoiler beim Fahrzeughändler bestellen.	01/20-			322 093 600 001		60	17.7	12.3	150	2500		322 080 300 113	für Fzg. ohne Vorrüstung	S	CAN	C	E	D	L	V	120
				322 094 600 001		60	17.7	12.3	150	2500		322 081 300 113	für Fzg. mit Vorrüstung	S	CAN	C	E	D	L	H	45
Skoda Octavia IV Limousine (NX3) für Fzg. ohne Vorrüstung auch für AdBlue auch für Hybrid Bei Fzg. ohne AHK-Vorbereitung bitte Original-Spoiler beim Fahrzeughändler bestellen.	01/20-	KIT		322 093 900 113		60	19.6	12.3	150	2500		im KIT enthalten 322 080 300 113	für Fzg. ohne Vorrüstung	S	CAN	C	E	D	L	V	120
				322 094 900 113		60	19.6	12.3	150	2500		im KIT enthalten 322 080 300 113	für Fzg. ohne Vorrüstung	S	CAN	C	E	D	L	V	120
Skoda Rapid / Rapid Spaceback auch für Monte Carlo nicht für Scoutline	10/12-07/15	KIT		317 129 900 113		45	23.0	8.5	50	1200		im KIT enthalten 317 420 300 113	-07/15	S	CAN	C	E	D1	L1	V	105
				317 130 900 113		45	23.0	8.5	50	1200		im KIT enthalten 317 420 300 113	-07/15	S	CAN	C	E	D1	L1	V	105
Skoda Rapid / Rapid Spaceback auch für Monte Carlo nicht für Scoutline	10/12-12/19			317 130 600 001		45	21.5	8.5	50	1200		317 420 300 113	-07/15	S	CAN	C	E	D1	L1	V	105
Skoda Rapid / Rapid Spaceback auch für Monte Carlo nicht für Scoutline	07/15-12/19	KIT		317 120 900 113		45	25.0	8.5	50	1200		im KIT enthalten 317 114 300 113	07/15-	S	CAN	C	E	D1	L1	V	90
Skoda Roomster auch für Skoda Praktik 07- auch für Scout	09/06-05/10	KIT		317 063 900 113		40	19.0	7.5	50	1200		im KIT enthalten 317 400 300 113	-05/10	S	C2	C	E	D1	--	H	45
Skoda Roomster auch für Skoda Praktik 07- auch für Scout Abdeckklappe bitte beim Skoda- Händler bestellen, Art.-Nr. XEA 77001	09/06-05/10	KIT		317 064 900 113		40	19.0	7.5	50	1200		im KIT enthalten 317 400 300 113	-05/10	S	C2	C	E	D1	--	H	45
Skoda Roomster auch für Skoda Praktik 07- auch für Scout	09/06-04/15			317 063 600 001		40	17.0	7.5	50	1200		317 400 300 113	-05/10	S	C2	C	E	D1	--	H	45
				317 420 300 113		40	17.0	7.5	50	1200		317 420 300 113	05/10-	S	CAN	C	E	D1	L1	V	105
Skoda Roomster auch für Skoda Praktik 07- auch für Scout Abdeckklappe bitte beim Skoda- Händler bestellen, Art.-Nr. XEA 77001	09/06-04/15			317 064 600 001		40	17.0	7.5	50	1200		317 400 300 113	-05/10	S	C2	C	E	D1	--	H	45
				317 420 300 113		40	17.0	7.5	50	1200		317 420 300 113	05/10-	S	CAN	C	E	D1	L1	V	105























Skoda

Skoda

























Skoda Roomster auch für Skoda Praktik 07- auch für Scout	05/10-04/15	KIT		317 420 900 113		40	19.0	7.5	50	1200		im KIT enthalten 317 420 300 113	05/10-	S	CAN	C	E	D1	L1	V	105	
Skoda Roomster auch für Skoda Praktik 07- auch für Scout Abdeckklappe bitte beim Skoda- Händler bestellen, Art.-Nr. XEA 77001	05/10-04/15	KIT		317 421 900 113		40	19.0	7.5	50	1200		im KIT enthalten 317 420 300 113	05/10-	S	CAN	C	E	D1	L1	V	105	
Skoda Scala nicht für CNG Bitte prüfen, ob Anhängelast in den Fahrzeugpapieren eingetragen ist.	02/19-			317 169 600 001		60	20.9	10.3	120	2000		344 110 300 113		S	CAN	C	E	D	L	V	60	
				317 170 600 001		60	23.2	10.3	120	2000												
		KIT		317 170 900 113		60	25.2	10.3	120	2000	im KIT enthalten 344 110 300 113											
Skoda Scala nur für Fzg. mit Anhängervorbereitung nicht für CNG	02/19-	KIT		317 169 900 113		60	22.9	10.3	120	2000		im KIT enthalten 344 110 300 113		S	CAN	C	E	D	L	V	60	
Skoda Superb nicht für Kfz mit Tuning-Paket der Fa. M+S	03/02-06/08			321 505 600 001	→	90	20.8	10.3	85	1800		300 072 300 113		--	FRE	--	--	D1	L1	V		
Skoda Superb Combi II auch für Facelift 06/13-	12/09-05/15			317 104 600 001		40	18.0	10.6	100	2000		321 600 300 113		S	FRE	C	E	D	L1	V	105	
				317 102 600 001		40	19.0	10.6	100	2000												
		KIT		317 104 900 113		40	20.0	10.6	100	2000	im KIT enthalten 321 600 300 113											
		KIT		317 102 900 113		40	21.0	10.6	100	2000	im KIT enthalten 321 600 300 113											
Skoda Superb Combi III (3V5) auch für Sportline auch für Plugin Hybrid (Bitte prüfen, ob Anhängelast in den Fahrzeugpapieren eingetragen ist.)	03/15-			317 140 600 001		90	15.0	11.5	100	2200		305 407 300 113		S	CAN	C	E	D	L	H	30	
				317 141 600 001		90	15.9	11.5	100	2200		305 408 300 107	→	für Fzg. ohne Vorrüstung	S	CAN	C	E	--	--	V	60
												305 408 300 113		für Fzg. ohne Vorrüstung	S	CAN	C	E	D	L	V	60























Skoda Superb Combi III (3V5) für Fzg. ohne Vorrüstung auch für Sportline auch für Plugin Hybrid (Bitte prüfen, ob Anhängelast in den Fahrzeugpapieren eingetragen ist.)	03/15-	KIT		317 140 900 113		90	19.6	11.5	100	2200	im KIT enthalten 305 408 300 113	für Fzg. ohne Vorrüstung	S	CAN	C	E	D	L	V	60
		KIT		317 143 900 113		90	17.4	11.5	100	2200	im KIT enthalten 305 438 300 113	inkl. WLC 2.0 für Fzg. ohne Vorrüstung	S	CAN	C	E	D	L1	V	90
		KIT		317 141 900 113		90	19.9	11.5	100	2200	im KIT enthalten 305 408 300 113	für Fzg. ohne Vorrüstung	S	CAN	C	E	D	L	V	60
		KIT		317 142 900 113		90	17.8	11.5	100	2200	im KIT enthalten 305 438 300 113	inkl. WLC 2.0 für Fzg. ohne Vorrüstung	S	CAN	C	E	D	L1	V	90
Skoda Superb Combi III (3V5) für Fzg. mit Vorrüstung auch für Sportline auch für Plugin Hybrid (Bitte prüfen, ob Anhängelast in den Fahrzeugpapieren eingetragen ist.)	03/15-	KIT		317 138 900 113		90	17.0	11.5	100	2200	im KIT enthalten 305 407 300 113	für Fzg. mit Vorrüstung	S	CAN	C	E	D	L	H	30
		KIT		317 139 900 113		90	17.5	11.5	100	2200	im KIT enthalten 305 407 300 113	für Fzg. mit Vorrüstung	S	CAN	C	E	D	L	H	30
Skoda Superb Limousine II auch für Facelift 06/13-	06/08-05/15			317 104 600 001		40	18.0	10.6	100	2000	321 600 300 113		S	FRE	C	E	D	L1	V	105
				317 102 600 001		40	19.0	10.6	100	2000										
		KIT		317 104 900 113		40	20.0	10.6	100	2000	im KIT enthalten 321 600 300 113		S	FRE	C	E	D	L1	V	105
		KIT		317 102 900 113		40	21.0	10.6	100	2000	im KIT enthalten 321 600 300 113		S	FRE	C	E	D	L1	V	105
Skoda Superb Limousine III (3V5) auch für Sportline auch für Plugin Hybrid (Bitte prüfen, ob Anhängelast in den Fahrzeugpapieren eingetragen ist.)	03/15-			317 141 600 001		90	15.9	11.5	100	2200	305 407 300 113	für Fzg. mit Vorrüstung	S	CAN	C	E	D	L	H	30
											305 408 300 107	→ für Fzg. ohne Vorrüstung	S	CAN	C	E	--	--	V	60
												305 408 300 113	für Fzg. ohne Vorrüstung	S	CAN	C	E	D	L	V

Skoda





Skoda Superb Limousine III (3V5) auch für Sportline auch für Plugin Hybrid (Bitte prüfen, ob Anhängelast in den Fahrzeugpapieren eingetragen ist.)	03/15-			317 140 600 001		90	15.0	11.5	100	2200		305 407 300 113	→	für Fzg. mit Vorrüstung	S	CAN	C	E	D	L	H	30
												305 408 300 107		für Fzg. ohne Vorrüstung	S	CAN	C	E	--	--	V	60
														305 408 300 113	für Fzg. ohne Vorrüstung	S	CAN	C	E	D	L	V
Skoda Superb Limousine III (3V5) für Fzg. ohne Vorrüstung auch für Sportline auch für Plugin Hybrid (Bitte prüfen, ob Anhängelast in den Fahrzeugpapieren eingetragen ist.)	03/15-	KIT		317 140 900 113		90	19.6	11.5	100	2200		im KIT enthalten 305 408 300 113		für Fzg. ohne Vorrüstung	S	CAN	C	E	D	L	V	60
		KIT		317 143 900 113		90	17.4	11.5	100	2200		im KIT enthalten 305 438 300 113		inkl. WLC 2.0 für Fzg. ohne Vorrüstung	S	CAN	C	E	D	L1	V	90
		KIT		317 141 900 113		90	19.9	11.5	100	2200		im KIT enthalten 305 408 300 113		für Fzg. ohne Vorrüstung	S	CAN	C	E	D	L	V	60
		KIT		317 142 900 113		90	17.8	11.5	100	2200		im KIT enthalten 305 438 300 113		inkl. WLC 2.0 für Fzg. ohne Vorrüstung	S	CAN	C	E	D	L1	V	90
Skoda Superb Limousine III (3V5) für Fzg. mit Vorrüstung auch für Sportline auch für Plugin Hybrid (Bitte prüfen, ob Anhängelast in den Fahrzeugpapieren eingetragen ist.)	03/15-	KIT		317 138 900 113		90	17.0	11.5	100	2200		im KIT enthalten 305 407 300 113		für Fzg. mit Vorrüstung	S	CAN	C	E	D	L	H	30
		KIT		317 139 900 113		90	17.5	11.5	100	2200		im KIT enthalten 305 407 300 113		für Fzg. mit Vorrüstung	S	CAN	C	E	D	L	H	30
Skoda Yeti	08/09-12/17			317 125 600 001		40	18.0	10.6	85	2100		317 079 300 107	→		S	CAN	C	E	--	--	V	105
												317 079 300 113			S	CAN	C	E	D	L1	V	105
		KIT		317 080 900 113		40	20.0	10.6	85	2100		im KIT enthalten 317 079 300 113			S	CAN	C	E	D	L1	V	105
Skoda Yeti Wir empfehlen, den Ausschnitt im Stoßfänger vom Skoda-Händler vornehmen zu lassen, da hierzu ein Spezialwerkzeug notwendig ist. Abdeckklappe und Rahmen für Stoßfängerausschnitt beim Skoda-Händler erhältlich.	08/09-12/17			317 128 600 001		40	19.5	10.6	85	2100		317 079 300 107	→		S	CAN	C	E	--	--	V	105
												317 079 300 113			S	CAN	C	E	D	L1	V	105
		KIT		317 105 900 113		40	20.5	10.6	85	2100		im KIT enthalten 317 079 300 113			S	CAN	C	E	D	L1	V	105

Subaru



















Subaru Levorg	09/15-12/21		348 064 600 001	→ 	60	22.5	8.7	90	1500																		
				348 065 600 001		60	24.0	8.7	90	1500																	
Subaru Outback (BS)	03/15-07/20		348 062 600 001		60	24.5	10.5	90	2000	348 062 300 113									S	FRE	--	E1	D1	L1	V	75	
				348 063 600 001		60	26.0	10.5	90		2000																
Subaru Outback BT	05/21-		348 085 600 001		90	19.2	10.8	125	2100																		
				348 086 600 001		90	21.5	10.8	125	2100																	
Subaru Solterra	06/22-		348 087 600 001		75	19.8	5.7	75	750																		
				348 088 600 001		75	19.8	5.7	75	750																	
Subaru Trezia	03/11-12/14		335 414 600 001		60	21.0	5.8	50	900																		
Subaru XV (GP)	03/12-10/17		348 037 600 001		90	20.0	8.9	75	1600	348 037 300 113									S	A	--	--	D	L1	V	90	
			KIT		348 037 900 113		90	22.0	8.9	75	1600	im KIT enthalten 348 037 300 113								S	A	--	--	D	L1	V	90
Subaru XV (GT)	10/17-10/23		348 078 600 001			75	21.4	8.0	90	1940	348 073 300 113	-10/23							S	A	C1	E1	D	L1	V	90	
			KIT		348 078 900 113			75	22.8	8.0	90	1940	im KIT enthalten 348 073 300 113	-10/23							S	A	C1	E1	D	L1	V















Suzuki Across A5Z auch für Plugin Hybrid nicht für Kfz. mit sensorgesteuerter Heckklappe	06/20-		335 510 600 001		60	23.0	10.2	100	2000	335 110 300 113				S	A	--	E2	D	L1	H	45	
			335 511 600 001		60	25.0	10.2	100	2000													
	KIT		335 510 900 113		60	24.4	10.2	100	2000	im KIT enthalten 335 110 300 113				S	A	--	E2	D	L1	H	45	
	KIT		335 511 900 113		60	26.8	10.2	100	2000	im KIT enthalten 335 110 300 113				S	A	--	E2	D	L1	H	45	
Suzuki Grand Vitara 3-Türer JT für Fahrzeuge mit Reserverad auf der Heckklappe	10/05-12/15		342 098 600 001		90	20.0	8.5	100	1600													
Suzuki Grand Vitara 5-Türer JT für Fahrzeuge mit Reserverad auf der Heckklappe	04/05-12/15		342 162 600 001	→ 	90	26.0	10.6	80	2000													
Suzuki Jimny	98-09/18		341 003 600 001		60	26.0	7.0	75	1300	300 072 300 107 300 072 300 113				--	FRE	--	--	--	--	V		
Suzuki Jimny (A6G)	07/18-		341 066 600 001		60	27.5	7.4	90	1500	341 052 300 113	07/18-			S	FRE	--	E1	D1	L1	V	60	
			341 067 600 001		30	19.0	7.4	90	1500													
	KIT		341 066 900 113		60	29.0	7.4	90	1500	im KIT enthalten 341 052 300 113	07/18-			S	FRE	--	E1	D1	L1	V	60	
	KIT		341 067 900 113		30	20.5	7.4	90	1500	im KIT enthalten 341 052 300 113	07/18-			S	FRE	--	E1	D1	L1	V	60	
Suzuki S-Cross II	01/22-		341 077 600 001		45	19.0	8.5	75	1500													
Suzuki SX4 S-Cross I JY	09/13-12/21		341 077 600 001		45	19.0	8.5	75	1500	341 024 300 107 341 024 300 113				S	FRE	--	--	--	--	H	60	
		KIT		341 024 900 113		45	22.0	8.5	75	1500	im KIT enthalten 341 024 300 113				S	FRE	--	--	D1	L1	H	60

Suzuki











Tesla Modell 3 (5YJ3) Bitte prüfen, ob Anhängelast in den Fahrzeugpapieren eingetragen ist.	01/19-			351 008 600 001			60	17.4	6.8	100	1000		351 008 300 113	01/19-	S	FRE	--	E2	--	--	H	45
													351 009 300 113	01/19-	S	A	--	E2	D	L1	H	60
Tesla Modell 3	01/19-	KIT		351 008 900 113			60	19.5	6.8	100	1000		im KIT enthalten 351 009 300 113	01/19-	S	A	--	E2	D	L1	H	60

















Toyota

Toyota Auris Touring Sports nicht für Hybrid	07/13-03/19			335 425 600 001		90	17.0	8.7	75	1500		335 423 300 113			S	FRE	--	E2	D	L1	V	120
		KIT		335 425 900 113		90	19.0	8.7	75	1500		im KIT enthalten 335 423 300 113			S	FRE	--	E2	D	L1	V	120
Toyota Avensis Wagon-Kombi / Touring Sports T27	01/09-10/18			335 345 600 001		60	24.0	10.3	80	2000		335 345 300 113			S	FRE	--	--	D	L1	V	105
				335 346 600 001		60	24.0	10.3	80	2000						S	FRE	--	--	D	L1	V
		KIT		335 345 900 113		60	26.0	10.3	80	2000		im KIT enthalten 335 345 300 113			S	FRE	--	--	D	L1	V	105
		KIT		335 346 900 113		60	26.0	10.3	80	2000		im KIT enthalten 335 345 300 113			S	FRE	--	--	D	L1	V	105
Toyota C-HR X1 auch für Hybrid	01/17-10/19	KIT		335 495 900 113		60	30.0	7.6	75	1300		im KIT enthalten 335 494 300 113	-10/19		S	FRE	--	E2	D	L1	H	75
Toyota C-HR X1 auch für Hybrid	01/17-10/23			335 495 600 001		60	25.5	7.6	75	1300		335 494 300 113	-10/19		S	FRE	--	E2	D	L1	H	75
Toyota Corolla (E21)	10/18-			335 514 600 001		60	18.9	7.6	90	2100		335 423 300 113	für Fzg. ohne Vorrüstung		S	FRE	--	E2	D	L1	V	120
				335 515 600 001		60	21.9	7.6	90	2100												
		KIT		335 514 900 113		60	20.6	7.6	90	2100		im KIT enthalten 335 423 300 113	für Fzg. ohne Vorrüstung		S	FRE	--	E2	D	L1	V	120
		KIT		335 515 900 113		60	23.6	7.6	90	2100		im KIT enthalten 335 423 300 113	für Fzg. ohne Vorrüstung		S	FRE	--	E2	D	L1	V	120

Toyota Corolla Touring Sports auch für Hybrid nicht für Kfz. mit sensorgesteuerter Heckklappe	02/19-		335 512 600 001		60	19.0	7.5	75	1300	335 423 300 113				S	FRE	--	E2	D	L1	V	120	
			335 513 600 001		60	22.0	7.5	75	1300													
	KIT		335 512 900 113		60	21.4	7.5	75	1300	im KIT enthalten 335 423 300 113					S	FRE	--	E2	D	L1	V	120
	KIT		335 513 900 113		60	24.4	7.5	75	1300	im KIT enthalten 335 423 300 113					S	FRE	--	E2	D	L1	V	120
Toyota Corolla Verso	04/04-09		335 323 600 001	→ 	70	24.0	8.6	75	1450													
Toyota Hilux Double Cab, 4x4 inkl. Kugelplatte nur für Fahrzeuge mit Unterfahrerschutz amtliche Typbezeichnung des Fzg. auf dem Typenschild: e11*2007/46*0148	10/10-		335 408 600 001		30	10.0	13.8	120	2500	335 456 300 113	09/16-			S	FRE	--	--	D	L1	V	75	
Toyota Hilux Double Cab, 4x4 inkl. Kugelplatte nur für Fahrzeuge mit Unterfahrerschutz amtliche Typbezeichnung des Fzg. auf dem Typenschild: e11*2007/46*0148	10/10-08/16		335 408 900 113		30	12.0	13.8	120	2500													
Toyota Hilux Double Cab, 4x4 inkl. Kugelplatte	09/16-		335 505 600 001		30	34.4	16.4	200	3500	335 456 300 113	09/16-			S	FRE	--	--	D	L1	V	75	
		KIT		335 505 900 113		30	35.0	16.4	200	3500	im KIT enthalten 335 456 300 113	09/16-			S	FRE	--	--	D	L1	V	75
Toyota Hilux Extra Cab, 4x4 inkl. Kugelplatte nur für Fahrzeuge mit Unterfahrerschutz amtliche Typbezeichnung des Fzg. auf dem Typenschild: e11*2007/46*0149	08/10-		335 408 600 001		30	10.0	13.8	120	2500	335 456 300 113	09/16-			S	FRE	--	--	D	L1	V	75	













Toyota

















Toyota Hilux Extra Cab, 4x4 inkl. Kugelplatte nur für Fahrzeuge mit Unterfahrschutz amtliche Typbezeichnung des Fzg. auf dem Typenschild: e11*2007/46*0149	08/10-08/16		335 408 900 113		30	12.0	13.8	120	2500												
Toyota Hilux Extra Cab, 4x4 inkl. Kugelplatte	09/16-		335 505 600 001		30	34.4	16.4	200	3500		335 456 300 113	09/16-	S	FRE	--	--	D	L1	V	75	
		KIT		335 505 900 113		30	35.0	16.4	200	3500		im KIT enthalten 335 456 300 113	09/16-	S	FRE	--	--	D	L1	V	75
Toyota Hilux Single Cab, 4x4 inkl. Kugelplatte nur für Fahrzeuge mit Unterfahrschutz amtliche Typbezeichnung des Fzg. auf dem Typenschild: e11*2007/46*0148	10/10-		335 408 600 001		30	10.0	13.8	120	2500		335 456 300 113	09/16-	S	FRE	--	--	D	L1	V	75	
Toyota Hilux Single Cab, 4x4 inkl. Kugelplatte nur für Fahrzeuge mit Unterfahrschutz amtliche Typbezeichnung des Fzg. auf dem Typenschild: e11*2007/46*0148	10/10-08/16		335 408 900 113		30	12.0	13.8	120	2500												
Toyota Hilux Single Cab, 4x4 inkl. Kugelplatte	09/16-		335 505 600 001		30	34.4	16.4	200	3500		335 456 300 113	09/16-	S	FRE	--	--	D	L1	V	75	
		KIT		335 505 900 113		30	35.0	16.4	200	3500		im KIT enthalten 335 456 300 113	09/16-	S	FRE	--	--	D	L1	V	75
Toyota Landcruiser J 12	01/03-10/09		335 294 600 001		75	8.5	16.3	130	3500		300 210 300 113		--	A	--	E1	D1	L1	V	90	
Toyota Landcruiser J 15 passende Anschraubplatten: 329062600001,329042600001, 329072600001. Kappe für Stoßfängerauschnitt bitte beim Toyota-Händler bestellen.	11/09-		335 397 600 001			16.0	16.3	130	3500		335 398 300 113		S	A	--	--	D	L1	H	75	

Toyota Landcruiser J 15 inkl. Anschraubplatten: 329062600001 Kappe für Stoßfängerausschnitt bitte beim Toyota-Händler bestellen.	11/09-	KIT		335 397 900 113		18.0	15.9	130	3500		im KIT enthalten 335 398 300 113			S	A	--	--	D	L1	H	75	
Toyota Landcruiser V8 / 200 J20	03/08-06/21			335 359 600 001		90	15.0	17.2	140	3500	300 210 300 113			--	A	--	E1	D1	L1	V	90	
Toyota Proace	04/12-02/16			306 331 600 001		75	22.5	12.2	122	2200	304 400 300 113			S	CAN	C1	E	D	L1	H	105	
				306 333 600 001		75	22.5	12.2	122	2200												
		KIT		306 331 900 113		75	22.5	12.2	122	2200	im KIT enthalten 304 400 300 113			S	CAN	C1	E	D	L1	H	105	
		KIT		306 333 900 113		75	24.5	12.2	122	2200	im KIT enthalten 304 400 300 113			S	CAN	C1	E	D	L1	H	105	
Toyota Proace auch für Proace Electric inkl. Kugelplatte	03/16-			304 190 600 001		45	26.0	13.9	104	2500	304 157 300 113	-10/19	S	CAN	C	E	D	L1	H	90		
											314 585 300 113	11/19- inkl. WLC 2.0 für Fzg. mit Vorrüstung auch für Proace Electric	S	FRE	C	E	D	L1	H	75		
Toyota Proace auch für Proace Electric	03/16-			335 106 600 001		60	25.5	13.9	104	2500	304 157 300 113	-10/19	S	CAN	C	E	D	L1	H	90		
											314 585 300 113	11/19- inkl. WLC 2.0 für Fzg. mit Vorrüstung auch für Proace Electric	S	FRE	C	E	D	L1	H	75		
Toyota Proace inkl. Kugelplatte	03/16-10/19	KIT		304 190 900 113		45	31.0	13.9	104	2500	im KIT enthalten 304 157 300 113	-10/19	S	CAN	C	E	D	L1	H	90		
Toyota Proace	03/16-10/19	KIT		335 106 900 113		60	28.5	13.9	104	2500	im KIT enthalten 304 157 300 113	-10/19	S	CAN	C	E	D	L1	H	90		
Toyota Proace auch für Proace Electric für Fzg. mit Vorrüstung inkl. Kugelplatte	11/19-	KIT		314 576 900 113		45	27.7	13.9	104	2500	im KIT enthalten 314 585 300 113	11/19- inkl. WLC 2.0 für Fzg. mit Vorrüstung auch für Proace Electric	S	FRE	C	E	D	L1	H	75		

Toyota



Toyota

























Toyota Proace auch für Proace Electric für Fzg. mit Vorrüstung	11/19-	KIT		314 578 900 113			60	27.2	13.9	104	2500		im KIT enthalten 314 585 300 113		11/19- inkl. WLC 2.0 für Fzg. mit Vorrüstung auch für Proace Electric	S	FRE	C	E	D	L1	H	75
Toyota Proace City L1 auch für City Verso	11/19-			304 207 600 001			60	20.0	8.6	75	1500		314 594 300 113		inkl. WLC 2.0	S	A	C	E	D	L	V	90
				304 118 600 001			90	17.0	8.4	64	1600												
				304 209 600 001			60	20.5	8.6	75	1500												
		KIT		304 207 900 113			60	21.2	8.6	75	1500	im KIT enthalten 314 594 300 113		inkl. WLC 2.0	S	A	C	E	D	L	V	90	
KIT		304 209 900 113			60	21.8	8.6	75	1500	im KIT enthalten 314 594 300 113		inkl. WLC 2.0	S	A	C	E	D	L	V	90			
Toyota Proace City L2 auch für City Verso	11/19-			304 210 600 001			60	21.0	8.6	75	1500		314 594 300 113		inkl. WLC 2.0	S	A	C	E	D	L	V	90
				304 212 600 001			60	21.5	8.6	75	1500												
		KIT		304 210 900 113			60	22.2	8.6	75	1500	im KIT enthalten 314 594 300 113		inkl. WLC 2.0	S	A	C	E	D	L	V	90	
		KIT		304 212 900 113			60	22.8	8.6	75	1500	im KIT enthalten 314 594 300 113		inkl. WLC 2.0	S	A	C	E	D	L	V	90	
Toyota Proace Verso auch für Proace Verso Electric	03/16-			335 106 600 001			60	25.5	13.9	104	2500		304 157 300 113		-10/19	S	CAN	C	E	D	L1	H	90
													314 585 300 113		11/19- inkl. WLC 2.0 für Fzg. mit Vorrüstung auch für Proace Verso Electric	S	FRE	C	E	D	L1	H	75
Toyota Proace Verso auch für Proace Verso Electric inkl. Kugelplatte	03/16-			304 190 600 001			45	26.0	13.9	104	2500		314 585 300 113		11/19- inkl. WLC 2.0 für Fzg. mit Vorrüstung auch für Proace Verso Electric	S	FRE	C	E	D	L1	H	75

Toyota Proace Verso	03/16-10/19	KIT		335 106 900 113			60	28.5	13.9	104	2500		im KIT enthalten 304 157 300 113	-10/19	S	CAN	C	E	D	L1	H	90	
Toyota Proace Verso inkl. Kugelplatte	03/16-10/19	KIT		304 190 900 113			45	31.0	13.9	104	2500		im KIT enthalten 304 157 300 113	-10/19	S	CAN	C	E	D	L1	H	90	
Toyota Proace Verso auch für Proace Verso Electric für Fzg. mit Vorrüstung inkl. Kugelplatte	11/19-	KIT		314 576 900 113			45	27.7	13.9	104	2500		im KIT enthalten 314 585 300 113	11/19- inkl. WLC 2.0 für Fzg. mit Vorrüstung auch für Proace Verso Electric	S	FRE	C	E	D	L1	H	75	
Toyota Proace Verso auch für Proace Verso Electric für Fzg. mit Vorrüstung	11/19-	KIT		314 578 900 113			60	27.2	13.9	104	2500		im KIT enthalten 314 585 300 113	11/19- inkl. WLC 2.0 für Fzg. mit Vorrüstung auch für Proace Verso Electric	S	FRE	C	E	D	L1	H	75	
Toyota RAV4 nicht in Verbindung mit nachrüstbarer Trittstufe	06/00-02/06			335 246 600 001		>150	16.7	9.8	75	2000													
Toyota RAV4 alle Modelle	03/06-13			335 325 600 001			90	36.0	10.4	80	2000		335 251 300 113		S	FRE	--	--	D1	L1	H	60	
		KIT		335 348 600 001			90	37.0	10.4	80	2000		im KIT enthalten 335 251 300 113		S	FRE	--	--	D1	L1	H	60	
Toyota RAV4 IV A4 nicht für Fahrzeuge mit Fußsensor	02/13-12/18			335 418 600 001		120	37.0	10.9	80	2000		335 419 300 113	-12/18	S	A	--	E1	D	L1	H	60		
				335 419 600 001		120	38.0	10.9	80	2000													
		KIT		335 418 900 113		120	37.0	10.9	80	2000		im KIT enthalten 335 419 300 113	-12/18	S	A	--	E1	D	L1	H	60		
		KIT		335 419 900 113		120	40.0	10.9	80	2000		im KIT enthalten 335 419 300 113	-12/18	S	A	--	E1	D	L1	H	60		

















Toyota







Volkswagen

VW Amarok für Kfz. mit Stoßfänger mit integrierter Trittstufe	08/10-05/20		321 831 600 001			30	7.2	15.7	140	3200		321 704 300 107	mit Vorrüstung	S	CAN	C	E	--	--	H	15	
												321 704 300 113	mit Vorrüstung	S	CAN	C	E	D	--	H	15	
VW Amarok für Kfz. mit Stoßfänger mit integrierter Trittstufe Anhängebock inkl. Kugelplatte	08/10-05/20		321 835 600 001			30	10.0	15.7	130	3200		321 704 300 107	mit Vorrüstung	S	CAN	C	E	--	--	H	15	
												321 704 300 113	mit Vorrüstung	S	CAN	C	E	D	--	H	15	
VW Arteon	04/17-		317 140 600 001			90	15.0	11.5	100	2200		305 407 300 113	für Fzg. mit Vorrüstung	S	CAN	C	E	D	L	H	30	
												305 408 300 107	→ für Fzg. ohne Vorrüstung	S	CAN	C	E	--	--	V	60	
												305 408 300 113	für Fzg. ohne Vorrüstung	S	CAN	C	E	D	L	V	60	
VW Arteon für Fzg. ohne Vorrüstung	04/17-	KIT		317 140 900 113			90	19.6	11.5	100	2200		im KIT enthalten 305 408 300 113	für Fzg. ohne Vorrüstung	S	CAN	C	E	D	L	V	60
													KIT		317 141 900 113			90	19.9	11.5	100	2200
VW Arteon für Fzg. mit Vorrüstung	04/17-	KIT		317 138 900 113			90	17.0	11.5	100	2200		im KIT enthalten 305 407 300 113	für Fzg. mit Vorrüstung	S	CAN	C	E	D	L	H	30
													KIT		317 139 900 113			90	17.5	11.5	100	2200
VW Arteon inkl. WLC 2.0 für Fzg. ohne Vorrüstung	04/17-	KIT		322 004 900 113			60	26.3	10.6	125	2100		im KIT enthalten 305 438 300 113	inkl. WLC 2.0 für Fzg. ohne Vorrüstung	S	CAN	C	E	D	L1	V	90
													KIT		317 142 900 113			90	17.8	11.5	100	2200
VW Arteon inkl. WLC 2.0 für Fzg. ohne Vorrüstung	04/17-	KIT		317 143 900 113			90	17.4	11.5	100	2200		im KIT enthalten 305 438 300 113	inkl. WLC 2.0 für Fzg. ohne Vorrüstung	S	CAN	C	E	D	L1	V	90

VW Arteon Shooting Brake 3H9 auch für AdBlue auch für R-Line Bitte Halter für Antennenverstärker separat bestellen:917131631001	06/20-			317 140 600 001		90	15.0	11.5	100	2200		305 407 300 113	→	für Fzg. mit Vorrüstung	S	CAN	C	E	D	L	H	30
				317 141 600 001		90	15.9	11.5	100	2200		305 408 300 107		für Fzg. ohne Vorrüstung	S	CAN	C	E	--	--	V	60
												305 408 300 113		für Fzg. ohne Vorrüstung	S	CAN	C	E	D	L	V	60
												305 438 300 113		inkl. WLC 2.0 für Fzg. ohne Vorrüstung	S	CAN	C	E	D	L1	V	90
VW Arteon Shooting Brake 3H9 für Fzg. ohne Vorrüstung auch für AdBlue auch für R-Line Bitte Halter für Antennenverstärker separat bestellen:917131631001	06/20-	KIT		317 140 900 113		90	19.6	11.5	100	2200		im KIT enthalten 305 408 300 113		für Fzg. ohne Vorrüstung	S	CAN	C	E	D	L	V	60
				317 143 900 113		90	17.4	11.5	100	2200		im KIT enthalten 305 438 300 113		inkl. WLC 2.0 für Fzg. ohne Vorrüstung	S	CAN	C	E	D	L1	V	90
				317 141 900 113		90	19.9	11.5	100	2200		im KIT enthalten 305 408 300 113		für Fzg. ohne Vorrüstung	S	CAN	C	E	D	L	V	60
				317 142 900 113		90	17.8	11.5	100	2200		im KIT enthalten 305 438 300 113		inkl. WLC 2.0 für Fzg. ohne Vorrüstung	S	CAN	C	E	D	L1	V	90
VW Arteon Shooting Brake 3H9 für Fzg. mit Vorrüstung auch für AdBlue auch für R-Line Bitte Halter für Antennenverstärker separat bestellen:917131631001	06/20-	KIT		317 138 900 113		90	17.0	11.5	100	2200		im KIT enthalten 305 407 300 113		für Fzg. mit Vorrüstung	S	CAN	C	E	D	L	H	30
				317 139 900 113		90	17.5	11.5	100	2200		im KIT enthalten 305 407 300 113		für Fzg. mit Vorrüstung	S	CAN	C	E	D	L	H	30
VW Bora Limousine nicht für Syncro - 4-Motion	10/98-05/05			305 222 600 001		120	17.5	8.9	75	1650		321 465 300 113			S	FRE	--	E	D1	L1	H	60
				305 223 600 001		120	16.8	8.9	75	1650												
			KIT		321 457 900 113		90	19.5	8.9	75	1650	im KIT enthalten 321 465 300 113										
			KIT		321 465 900 113		90	18.8	8.9	75	1650	im KIT enthalten 321 465 300 113										







Volkswagen





VW Bora Variant nicht für Syncro - 4-Motion	10/98-05/05		305 222 600 001		120	17.5	8.9	75	1650	321 457 300 113				S	FRE	--	E	D1	L1	H	60	
			305 223 600 001		120	16.8	8.9	75	1650													
		KIT		305 222 900 113		90	19.5	8.9	75	1650	im KIT enthalten 321 457 300 113				S	FRE	--	E	D1	L1	H	60
		KIT		305 223 900 113		90	18.8	8.9	75	1650	im KIT enthalten 321 457 300 113											
VW CC	12-11/16		321 821 600 001		90	17.5	11.3	90	2200	321 600 300 113				S	FRE	C	E	D	L1	V	105	
			321 823 600 001		90	20.0	11.3	90	2200													
		KIT		321 821 900 113		90	19.5	11.3	90	2200	im KIT enthalten 321 600 300 113				S	FRE	C	E	D	L1	V	105
		KIT		321 823 900 113		90	22.0	11.3	90	2200	im KIT enthalten 321 600 300 113											
VW Caddy 4x4 / 4-Motion inkl. Stoßfängerträger auch für Caddy Cross 10/13- auch für Caddy Alltrack 16-	10/08-09/20		321 768 600 001		75	19.5	8.9	80	1500	321 554 300 107	09/10-09/20	S	CAN	C	E	--	--	V	105			
										321 554 300 113	09/10-09/20	S	CAN	C	E	D	L1	V	105			
										321 557 300 107	-08/10	S	CAN	C	E	--	--	V	105			
										321 557 300 113	-08/10	S	CAN	C	E	D	L1	V	105			
										321 661 300 113	01/13- mit Vorrüstung	S	CAN	C	E	D	L1	H	30			
										321 673 300 113	09/10-09/20	S	CAN	C	E	D	L1	V	105			
VW Caddy 4x4 / 4-Motion inkl. Stoßfängerträger auch für Caddy Cross 10/13- auch für Caddy Alltrack 16- inkl. Kugelplatte	10/08-09/20		321 837 600 001		75	20.5	8.9	80	1500	321 554 300 107	09/10-09/20	S	CAN	C	E	--	--	V	105			
										321 554 300 113	09/10-09/20	S	CAN	C	E	D	L1	V	105			
										321 557 300 107	-08/10	S	CAN	C	E	--	--	V	105			
										321 557 300 113	-08/10	S	CAN	C	E	D	L1	V	105			
										321 661 300 113	01/13- mit Vorrüstung	S	CAN	C	E	D	L1	H	30			
										321 673 300 113	09/10-09/20	S	CAN	C	E	D	L1	V	105			

VW Caddy III + IV / Caddy Life auch für Caddy Maxi nicht für Kfz. mit Gasbetrieb inkl. Blechträger für Stoßfänger Aufnahmebox für abnehmbare Kugelstange 2K0 804 969 bitte beim VW-Händler bestellen.	02/04-08/10	KIT		321 659 900 113			75	19.0	9.4	80	1650		im KIT enthalten 321 673 300 113	09/10-09/20	S	CAN	C	E	D	L1	V	105
													im KIT enthalten 321 557 300 113	-08/10	S	CAN	C	E	D	L1	V	105
VW Caddy III + IV / Caddy Life auch für Caddy Maxi inkl. Stoßfängerträger 5-Sitzer: auch für Kfz. mit Gasbetrieb 7-Sitzer: nicht für Kfz. mit Gasbetrieb	02/04-08/10	KIT		321 661 900 113			75	22.5	9.4	80	1650		im KIT enthalten 321 557 300 113	-08/10	S	CAN	C	E	D	L1	V	105
VW Caddy III + IV / Caddy Life auch für Caddy Maxi auch für Caddy Alltrack 16- inkl. Stoßfängerträger 5-Sitzer: auch für Kfz. mit Gasbetrieb 7-Sitzer: nicht für Kfz. mit Gasbetrieb	02/04-09/20			321 661 600 001			75	19.5	9.4	80	1650		321 554 300 107	09/10-09/20	S	CAN	C	E	--	--	V	105
													321 554 300 113	09/10-09/20	S	CAN	C	E	D	L1	V	105
													321 557 300 107	-08/10	S	CAN	C	E	--	--	V	105
													321 557 300 113	-08/10	S	CAN	C	E	D	L1	V	105
													321 661 300 113	01/13- mit Vorrüstung	S	CAN	C	E	D	L1	H	30
													321 673 300 113	09/10-09/20	S	CAN	C	E	D	L1	V	105
VW Caddy III + IV / Caddy Life auch für Caddy Maxi auch für Caddy Alltrack 16- nicht für Kfz. mit Gasbetrieb inkl. Blechträger für Stoßfänger Aufnahmebox für abnehmbare Kugelstange 2K0 804 969 bitte beim VW-Händler bestellen.	02/04-09/20			321 673 600 001			75	18.0	9.4	80	1650		321 554 300 107	09/10-09/20	S	CAN	C	E	--	--	V	105
													321 554 300 113	09/10-09/20	S	CAN	C	E	D	L1	V	105
													321 557 300 107	-08/10	S	CAN	C	E	--	--	V	105
													321 557 300 113	-08/10	S	CAN	C	E	D	L1	V	105
													321 661 300 113	01/13- mit Vorrüstung	S	CAN	C	E	D	L1	H	30
													321 673 300 113	09/10-09/20	S	CAN	C	E	D	L1	V	105
VW Caddy III + IV / Caddy Life auch für Caddy Maxi auch für Caddy Alltrack 16- inkl. Stoßfängerträger 5-Sitzer: auch für Kfz. mit Gasbetrieb 7-Sitzer: nicht für Kfz. mit Gasbetrieb	09/10-09/20	KIT		321 554 900 113			75	21.5	9.4	80	1650		im KIT enthalten 321 554 300 113	09/10-09/20	S	CAN	C	E	D	L1	V	105
VW Caddy III + IV / Caddy Life auch für Caddy Maxi auch für Caddy Alltrack 16- nicht für Kfz. mit Gasbetrieb inkl. Blechträger für Stoßfänger Aufnahmebox für abnehmbare Kugelstange 2K0 804 969 bitte beim VW-Händler bestellen.	09/10-09/20	KIT		321 660 900 113			75	20.0	9.4	80	1650		im KIT enthalten 321 554 300 113	09/10-09/20	S	CAN	C	E	D	L1	V	105







Volkswagen





Volkswagen

VW Caddy V	09/20-		322 088 600 001			90	20.0	9.8	119	1620		322 088 300 113		09/20- für Fzg. mit Vorrüstung	S	CAN	C	E	D	L	H	30
			322 089 600 001			90	23.0	9.8	119	1620		322 089 300 113		09/20- für Fzg. ohne Vorrüstung	S	CAN	C	E	D	L	V	60
			322 092 300 113									322 092 300 113		09/20- für Fzg. ohne Vorrüstung, inkl. WLC 2.0	S	CAN	C	E	D	L	V	90
VW Caddy V für Fzg. ohne Vorrüstung	09/20-	KIT 	322 088 900 113			90	22.0	9.8	119	1620		im KIT enthalten 322 092 300 113		09/20- für Fzg. ohne Vorrüstung, inkl. WLC 2.0	S	CAN	C	E	D	L	V	90
			322 089 900 113			90	25.0	9.8	119	1620		im KIT enthalten 322 092 300 113		09/20- für Fzg. ohne Vorrüstung, inkl. WLC 2.0	S	CAN	C	E	D	L	V	90
VW Caddy V für Fzg. mit Vorrüstung	09/20-	KIT 	322 086 900 113			90	21.5	9.8	119	1620		im KIT enthalten 322 088 300 113		09/20- für Fzg. mit Vorrüstung	S	CAN	C	E	D	L	H	30
			322 087 900 113			90	24.5	9.8	119	1620		im KIT enthalten 322 088 300 113		09/20- für Fzg. mit Vorrüstung	S	CAN	C	E	D	L	H	30
VW Crafter Kasten/Kombi für Fzg. ohne Vorrüstung Typen 30/35/38 Fzg. mit 3,0 und 3,5 t zGG, Aufüstung auf 3,8 t zGG möglich bei Fzg. mit Stoßfänger mit integrierter Trittstufe muss das mittlere Teil der Außenhaut ausgetauscht werden (erhältlich beim VW-Händler) inkl. Kugelplatte VW-Auftritt kann nicht verwendet werden. Passende Trittstufen: 313285600001 / 313440600001	04/06-12/14	KIT 	313 376 900 113			120	22.0	18.1	150	3500		im KIT enthalten 313 105 300 113		-12/14 für Fzg. ohne Vorrüstung	S	CAN	C	E	D1	--	V	90
VW Crafter Kasten/Kombi Typen 46 und 50 Fzg. mit 5,0 t zGG, Ablastung auf 4,6 t zGG möglich Radstand: 3665 mm bei Fzg. mit Stoßfänger mit integrierter Trittstufe muss das mittlere Teil der Außenhaut ausgetauscht werden (erhältlich beim VW-Händler) passende Kugelplatte: 329141600001 VW-Auftritt kann nicht verwendet werden. Passende Trittstufen: 313285600001 / 313440600001	04/06-12/16		313 272 600 001			120	22.0	20.2	150	3500		313 105 300 107		-12/14 für Fzg. ohne Vorrüstung	S	CAN	C	E	--	--	V	90
												313 105 300 113		-12/14 für Fzg. ohne Vorrüstung	S	CAN	C	E	D1	--	V	90
												313 107 300 113		01/15- für Fzg. mit Vorrüstung	S	CAN	C	E	D1	L1	H	45
												313 108 300 113		01/15- für Fzg. ohne Vorrüstung	S	CAN	C	E	D1	L1	V	90
												321 106 300 113		-12/14 für Fzg. mit Vorrüstung	S	CAN	C	E	D	--	H	45





















VW Crafter Kasten/Kombi Typen 46 und 50 Fzg. mit 5,0 t zGG, Ablastung auf 4,6 t zGG möglich Radstand: 4325 mm bei Fzg. mit Stoßfänger mit integrierter Trittstufe muss das mittlere Teil der Außenhaut ausgetauscht werden (erhältlich beim VW-Händler) passende Kugelplatte: 329141600001 VW-Austritt kann nicht verwendet werden. Passende Trittstufen: 313285600001 / 313440600001	04/06-12/16		313 273 600 001		120	23.0	20.2	150	3500	313 105 300 107 →	-12/14 für Fzg. ohne Vorrüstung	S	CAN	C	E	--	--	V	90
										313 105 300 113	-12/14 für Fzg. ohne Vorrüstung	S	CAN	C	E	D1	--	V	90
										313 107 300 113	01/15- für Fzg. mit Vorrüstung	S	CAN	C	E	D1	L1	H	45
										313 108 300 113	01/15- für Fzg. ohne Vorrüstung	S	CAN	C	E	D1	L1	V	90
										321 106 300 113	-12/14 für Fzg. mit Vorrüstung	S	CAN	C	E	D	--	H	45
VW Crafter Kasten/Kombi Typen 30/35/38 Fzg. mit 3,0 und 3,5 t zGG, Auflastung auf 3,8 t zGG möglich. Nur Fahrzeuge ohne Trittstufe. Für Fahrzeuge mit Trittstufe Art.-Nr.313553600001. passende Kugelplatte: 329141600001 VW-Austritt kann nicht verwendet werden. Passende Trittstufen: 313285600001 / 313440600001	04/06-12/16		313 376 600 001		120	20.0	18.1	150	3500	313 105 300 107 →	-12/14 für Fzg. ohne Vorrüstung	S	CAN	C	E	--	--	V	90
										313 105 300 113	-12/14 für Fzg. ohne Vorrüstung	S	CAN	C	E	D1	--	V	90
										313 107 300 113	01/15- für Fzg. mit Vorrüstung	S	CAN	C	E	D1	L1	H	45
										313 108 300 113	01/15- für Fzg. ohne Vorrüstung	S	CAN	C	E	D1	L1	V	90
										321 106 300 113	-12/14 für Fzg. mit Vorrüstung	S	CAN	C	E	D	--	H	45
VW Crafter Kasten/Kombi für Fzg. ohne Vorrüstung Typen 30/35/38 Fzg. mit 3,0 und 3,5 t zGG, Auflastung auf 3,8 t zGG möglich bei Fzg. mit Stoßfänger mit integrierter Trittstufe muss das mittlere Teil der Außenhaut ausgetauscht werden (erhältlich beim VW-Händler) inkl. Kugelplatte VW-Austritt kann nicht verwendet werden. Passende Trittstufen: 313285600001 / 313440600001	01/15-12/16	KIT 	313 108 900 113		120	23.0	18.1	150	3500	im KIT enthalten 313 108 300 113	01/15- für Fzg. ohne Vorrüstung	S	CAN	C	E	D1	L1	V	90
VW Crafter Kasten/Kombi Einfachbereifung Kugelplatte bitte separat bestellen: 329141600001 nicht für Kfz mit integrierter Trittstufe im Stoßfänger Bitte ggfs. Unterfahrschutz tauschen. nicht für e-Crafter	01/17-		321 946 600 001		30	26.7	17.5	150	3500	321 112 300 113	für Fzg. mit Vorrüstung	S	CAN	--	E	D	L	V	15
										321 113 300 107	für Fzg. ohne Vorrüstung	S	CAN	C	E	--	--	V	60
										321 113 300 113	für Fzg. ohne Vorrüstung	S	CAN	C	E	D	L	V	60

























Volkswagen

VW Crafter Kasten/Kombi Zwillingsbereifung Kugelplatte bitte separat bestellen: 329141600001 nicht für Kfz mit integrierter Tritstufe im Stoßfänger Bitte ggfs.Unterfahrschutz tauschen. nicht für e-Crafter	01/17-		321 947 600 001			30	27.0	21.0	150	3500		321 112 300 113	für Fzg. mit Vorrüstung	S	CAN	--	E	D	L	V	15
												321 113 300 107	für Fzg. ohne Vorrüstung	S	CAN	C	E	--	--	V	60
												321 113 300 113	für Fzg. ohne Vorrüstung	S	CAN	C	E	D	L	V	60
VW Crafter Kasten/Kombi für Fzg. ohne Vorrüstung Zwillingsbereifung inkl. Kugelplatte nicht für Kfz mit integrierter Tritstufe im Stoßfänger Bitte ggfs.Unterfahrschutz tauschen. nicht für e-Crafter	01/17-	KIT		321 947 900 113		30	30.0	21.0	150	3500		im KIT enthalten 321 113 300 113	für Fzg. ohne Vorrüstung	S	CAN	C	E	D	L	V	60
VW Crafter Kasten/Kombi für Fzg. ohne Vorrüstung Einfachbereifung inkl. Kugelplatte nicht für Kfz mit integrierter Tritstufe im Stoßfänger Bitte ggfs.Unterfahrschutz tauschen. nicht für e-Crafter	01/17-	KIT		321 946 900 113		30	28.5	17.5	150	3500		im KIT enthalten 321 113 300 113	für Fzg. ohne Vorrüstung	S	CAN	C	E	D	L	V	60
VW Crafter Kasten/Kombi Einfachbereifung inkl. Kugelplatte nur für Kfz mit integrierter Tritstufe im Stoßfänger nicht für e-Crafter	01/17-		322 011 600 001			60	29.7	15.8	120	3000		321 112 300 113	für Fzg. mit Vorrüstung	S	CAN	--	E	D	L	V	15
												321 113 300 107	für Fzg. ohne Vorrüstung	S	CAN	C	E	--	--	V	60
												321 113 300 113	für Fzg. ohne Vorrüstung	S	CAN	C	E	D	L	V	60
VW Crafter Pritsche/Fahrgestell für Fzg. ohne Vorrüstung Typen 46 und 50 Fzg. mit 5,0 t zGG, Ablastung auf 4,6 t zGG möglich Radstand: 3665 + 4325 mm inkl. Kugelplatte Evt. vorhandenen Unterfahrschutz austauschen und neu VW-Nr. 2E3 805 721 A montieren.	04/06-12/14	KIT		313 275 900 113		90	20.0	20.2	150	3500		im KIT enthalten 313 105 300 113	-12/14 für Fzg. ohne Vorrüstung	S	CAN	C	E	D1	--	V	90
VW Crafter Pritsche/Fahrgestell für Fzg. ohne Vorrüstung Typen 30/35/38 Fzg. mit 3,0 und 3,5 t zGG, Auflastung auf 3,8 t zGG möglich nicht für Fzg. mit Unterfahrschutz inkl. Kugelplatte	04/06-12/14	KIT		313 377 900 113	→	90	22.0	18.1	150	3500		im KIT enthalten 313 105 300 113	-12/14 für Fzg. ohne Vorrüstung	S	CAN	C	E	D1	--	V	90























VW Crafter Pritsche/Fahrgestell für Fzg. ohne Vorrüstung Typen 30/35/38 Fzg. mit 3,0 und 3,5 t zGG, Auflastung auf 3,8 t zGG möglich nicht für Fzg. mit Unterfahrschutz inkl. Kugelplatte	04/06-12/14	KIT		313 522 900 113			60	21.8	20.2	240	3500		im KIT enthalten 313 105 300 113		-12/14 für Fzg. ohne Vorrüstung	S	CAN	C	E	D1	--	V	90
VW Crafter Pritsche/Fahrgestell Typen 46 und 50 Fzg. mit 5,0 t zGG, Ablastung auf 4,6 t zGG möglich Radstand: 3665 + 4325 mm Kugelplatte: 329059600001 Evt. vorhandenen Unterfahrschutz austauschen und neu VW-Nr. 2E3 805 721 A montieren.	04/06-12/16			313 275 600 001			90	18.0	20.2	150	3500		313 105 300 107	→	-12/14 für Fzg. ohne Vorrüstung	S	CAN	C	E	--	--	V	90
													313 105 300 113		-12/14 für Fzg. ohne Vorrüstung	S	CAN	C	E	D1	--	V	90
													313 107 300 113		01/15- für Fzg. mit Vorrüstung	S	CAN	C	E	D1	L1	H	45
													313 108 300 113		01/15- für Fzg. ohne Vorrüstung	S	CAN	C	E	D1	L1	V	90
													321 106 300 113		-12/14 für Fzg. mit Vorrüstung	S	CAN	C	E	D	--	H	45
VW Crafter Pritsche/Fahrgestell Typen 30/35/38 Fzg. mit 3,0 und 3,5 t zGG, Auflastung auf 3,8 t zGG möglich nicht für Fzg. mit Unterfahrschutz passende Kugelplatte: 329059600001	04/06-12/16			313 377 600 001	→		90	20.0	18.1	150	3500		313 105 300 107	→	-12/14 für Fzg. ohne Vorrüstung	S	CAN	C	E	--	--	V	90
													313 105 300 113		-12/14 für Fzg. ohne Vorrüstung	S	CAN	C	E	D1	--	V	90
													313 107 300 113		01/15- für Fzg. mit Vorrüstung	S	CAN	C	E	D1	L1	H	45
													313 108 300 113		01/15- für Fzg. ohne Vorrüstung	S	CAN	C	E	D1	L1	V	90
													321 106 300 113		-12/14 für Fzg. mit Vorrüstung	S	CAN	C	E	D	--	H	45
VW Crafter Pritsche/Fahrgestell Typen 30/35/38 Fzg. mit 3,0 und 3,5 t zGG, Auflastung auf 3,8 t zGG möglich nicht für Fzg. mit Unterfahrschutz inkl. Kugelplatte (nur Verwendung 2-Loch-Flansch möglich)	04/06-12/16			313 522 600 001			60	19.6	20.2	240	3500		313 105 300 113		-12/14 für Fzg. ohne Vorrüstung	S	CAN	C	E	D1	--	V	90
VW Crafter Pritsche/Fahrgestell für Fzg. ohne Vorrüstung Typen 30/35/38 Fzg. mit 3,0 und 3,5 t zGG, Auflastung auf 3,8 t zGG möglich nicht für Fzg. mit Unterfahrschutz Kugelplatte 3290806000001 inkl.	01/15-12/16	KIT		313 107 900 113			60	22.9	20.2	240	3500		im KIT enthalten 313 108 300 113		01/15- für Fzg. ohne Vorrüstung	S	CAN	C	E	D1	L1	V	90













Volkswagen

VW Crafter Pritsche/Fahrgestell Einfachbereifung Kugelplatte bitte separat bestellen: 329141600001 nicht für e-Crafter	01/17-		321 948 600 001			30	22.0	21.0	150	3500		321 112 300 113	für Fzg. mit Vorrüstung	S	CAN	--	E	D	L	V	15
						321 113 300 107	für Fzg. ohne Vorrüstung	S	CAN	C		E	--	--	V	60					
						321 113 300 113	für Fzg. ohne Vorrüstung	S	CAN	C		E	D	L	V	60					
VW Crafter Pritsche/Fahrgestell für Fzg. ohne Vorrüstung Einfachbereifung inkl. Kugelplatte nicht für e-Crafter	01/17-	KIT 	321 948 900 113			30	26.5	21.0	150	3500		im KIT enthalten 321 113 300 113	für Fzg. ohne Vorrüstung	S	CAN	C	E	D	L	V	60
VW Eos / Cabrio Spoiler inkl. Abdeckklappe bitte beim VW-Händler bestellen. auch für Facelift 01/11-	06/06-12/15		321 543 600 001			75	18.0	9.3	100	1800		321 600 300 113		S	FRE	C	E	D	L1	V	105
VW Golf IV Limousine nicht für Syncro - 4-Motion und Cabrio nicht für Golf R32 / 241 PS	10/97-10/03		305 222 600 001			120	17.5	8.9	75	1650		321 465 300 113	-10/03	S	FRE	--	E	D1	L1	H	60
				305 223 600 001			120	16.8	8.9	75	1650										
		KIT 	321 457 900 113			90	19.5	8.9	75	1650		im KIT enthalten 321 465 300 113	-10/03	S	FRE	--	E	D1	L1	H	60
		KIT 	321 465 900 113			90	18.8	8.9	75	1650		im KIT enthalten 321 465 300 113	-10/03	S	FRE	--	E	D1	L1	H	60
VW Golf IV Variant nicht für Syncro - 4-Motion und Cabrio nicht für Golf R32 / 241 PS	10/97-05/07		305 222 600 001			120	17.5	8.9	75	1650		321 457 300 113	-05/07	S	FRE	--	E	D1	L1	H	60
				305 223 600 001			120	16.8	8.9	75	1650										
		KIT 	305 222 900 113			90	19.5	8.9	75	1650		im KIT enthalten 321 457 300 113	-05/07	S	FRE	--	E	D1	L1	H	60
		KIT 	305 223 900 113			90	18.8	8.9	75	1650		im KIT enthalten 321 457 300 113	-05/07	S	FRE	--	E	D1	L1	H	60















VW Golf V Limousine nicht für R/RS32 09/05- nicht für R/R20 / 270 PS 09- auch für 4-Motion / Gti	11/03-09/08		321 865 600 001		60	17.0	9.4	100	1800	321 600 300 113	-09/08	S	FRE	C	E	D	L1	V	105
		KIT		321 750 900 113		60	18.5	9.4	100	1800	im KIT enthalten 321 600 300 113	-09/08	S	FRE	C	E	D	L1	V
VW Golf V Limousine nicht für R/RS32 09/05- nicht für R/R20 / 270 PS 09- auch für 4-Motion / Gti Bitte Spoiler und Abdeckklappe für Stoßfängerausschnitt beim VW-Händler bestellen.	11/03-09/08		321 885 600 001		60	17.0	9.4	100	1800	321 600 300 113	-09/08	S	FRE	C	E	D	L1	V	105
		KIT		321 751 900 113		60	18.5	9.4	100	1800	im KIT enthalten 321 600 300 113	-09/08	S	FRE	C	E	D	L1	V
VW Golf V Plus auch für Cross Golf nicht für RS32 09/05- nicht für R20 / 270 PS 09- auch für 4-Motion / Gti	03/05-02/09		321 865 600 001		60	17.0	9.4	100	1800	321 600 300 113	-02/09	S	FRE	C	E	D	L1	V	105
		KIT		321 750 900 113		60	18.5	9.4	100	1800	im KIT enthalten 321 600 300 113	-02/09	S	FRE	C	E	D	L1	V
VW Golf V Plus auch für Cross Golf nicht für RS32 09/05- nicht für R20 / 270 PS 09- auch für 4-Motion / Gti Bitte Spoiler und Adeckklappe für Stoßfängerausschnitt beim VW- Händler bestellen.	03/05-02/09		321 885 600 001		60	17.0	9.4	100	1800	321 600 300 113	-02/09	S	FRE	C	E	D	L1	V	105
		KIT		321 751 900 113		60	18.5	9.4	100	1800	im KIT enthalten 321 600 300 113	-02/09	S	FRE	C	E	D	L1	V
VW Golf V Variant auch für 4-Motion Bitte Spoiler beim VW-Händler bestellen.	06/07-05/09		321 630 600 001		90	17.0	9.3	100	1800	321 600 300 113	-05/09	S	FRE	C	E	D	L1	V	105
		KIT		321 630 900 113		90	21.0	9.3	100	1800	im KIT enthalten 321 600 300 113	-05/09	S	FRE	C	E	D	L1	V
VW Golf V Variant auch für 4-Motion	06/07-05/09		321 662 600 001		90	17.0	9.3	100	1800	321 600 300 113	-05/09	S	FRE	C	E	D	L1	V	105
		KIT		321 662 900 113		90	19.0	9.3	100	1800	im KIT enthalten 321 600 300 113	-05/09	S	FRE	C	E	D	L1	V













Volkswagen

VW Golf VI Cabrio Ausschnitt gemäß Schablone, alternativ Spoiler + Klappe beim VW-Händler erhältlich	06/11-05/16			321 873 600 001		60	17.0	9.4	75	1800		305 256 300 113	-05/16	S	CAN	C	E	D1	--	V	120
		KIT		321 730 900 113		60	19.0	9.4	75	1800		im KIT enthalten 305 256 300 113	-05/16	S	CAN	C	E	D1	--	V	120
VW Golf VI Limousine nicht für R/RS32 09/05- nicht für R/R20 / 270 PS 09- auch für 4-Motion / Gti	10/08-09/12			321 865 600 001		60	17.0	9.4	100	1800		321 600 300 113	-09/12	S	FRE	C	E	D	L1	V	105
		KIT		321 750 900 113		60	18.5	9.4	100	1800		im KIT enthalten 321 600 300 113	-09/12	S	FRE	C	E	D	L1	V	105
VW Golf VI Limousine nicht für R/RS32 09/05- nicht für R/R20 / 270 PS 09- auch für 4-Motion / Gti Bitte Spoiler und Abdeckklappe für Stoßfängerausschnitt beim VW-Händler bestellen.	10/08-09/12			321 885 600 001		60	17.0	9.4	100	1800		321 600 300 113	-09/12	S	FRE	C	E	D	L1	V	105
		KIT		321 751 900 113		60	18.5	9.4	100	1800		im KIT enthalten 321 600 300 113	-09/12	S	FRE	C	E	D	L1	V	105
VW Golf VI Plus auch für Cross Golf nicht für RS32 09/05- nicht für R20 / 270 PS 09- auch für 4-Motion / Gti	03/09-12/13			321 865 600 001		60	17.0	9.4	100	1800		321 600 300 113	-12/13	S	FRE	C	E	D	L1	V	105
		KIT		321 750 900 113		60	18.5	9.4	100	1800		im KIT enthalten 321 600 300 113	-12/13	S	FRE	C	E	D	L1	V	105
VW Golf VI Plus auch für Cross Golf nicht für RS32 09/05- nicht für R20 / 270 PS 09- auch für 4-Motion / Gti Bitte Spoiler und Adeckklappe für Stoßfängerausschnitt beim VW- Händler bestellen.	03/09-12/13			321 885 600 001		60	17.0	9.4	100	1800		321 600 300 113	-12/13	S	FRE	C	E	D	L1	V	105
		KIT		321 751 900 113		60	18.5	9.4	100	1800		im KIT enthalten 321 600 300 113	-12/13	S	FRE	C	E	D	L1	V	105
VW Golf VI Variant auch für 4-Motion Bitte Spoiler beim VW-Händler bestellen.	06/09-07/13			321 630 600 001		90	17.0	9.3	100	1800		321 600 300 113	-07/13	S	FRE	C	E	D	L1	V	105
		KIT		321 630 900 113		90	21.0	9.3	100	1800		im KIT enthalten 321 600 300 113	-07/13	S	FRE	C	E	D	L1	V	105





















VW Golf VI Variant auch für 4-Motion	06/09-07/13			321 662 600 001		90	17.0	9.3	100	1800		321 600 300 113	-07/13	S	FRE	C	E	D	L1	V	105
		KIT		321 662 900 113		90	19.0	9.3	100	1800		im KIT enthalten 321 600 300 113	-07/13	S	FRE	C	E	D	L1	V	105
VW Golf VII Limousine (AU) für Fzg. ohne Vorrüstung nicht für e-Golf	10/12-06/14	KIT		317 131 900 113		60	21.0	10.3	85	2000		im KIT enthalten 305 406 300 113	-06/14 für Fzg. ohne Vorrüstung	S	CAN	C	E	D	L1	V	150
VW Golf VII Limousine (AU) für Fzg. ohne Vorrüstung nicht für e-Golf Spoiler inkl. Abdeckklappe bitte beim VW-Händler bestellen.	10/12-06/14	KIT		317 132 900 113		60	21.0	10.3	85	2000		im KIT enthalten 305 406 300 113	-06/14 für Fzg. ohne Vorrüstung	S	CAN	C	E	D	L1	V	150
VW Golf VII Limousine (AU) nicht für e-Golf, GTI TCR, GTI Clubsport	10/12-07/19			317 131 600 001		60	19.0	10.3	85	2000		305 403 300 113	-06/14 für Fzg. mit Vorrüstung	S	CAN	C	E	D	L1	H	45
												305 406 300 113	-06/14 für Fzg. ohne Vorrüstung	S	CAN	C	E	D	L1	V	150
												305 407 300 113	06/14-07/19 für Fzg. mit Vorrüstung	S	CAN	C	E	D	L	H	30
												305 408 300 107	→ 06/14-07/19 für Fzg. ohne Vorrüstung	S	CAN	C	E	--	--	V	60
												305 408 300 113	06/14-07/19 für Fzg. ohne Vorrüstung	S	CAN	C	E	D	L	V	60
VW Golf VII Limousine (AU) nicht für e-Golf, GTI TCR, GTI Clubsport Spoiler inkl. Abdeckklappe bitte beim VW-Händler bestellen.	10/12-07/19			317 132 600 001		60	19.0	10.3	85	2000		305 403 300 113	-06/14 für Fzg. mit Vorrüstung	S	CAN	C	E	D	L1	H	45
												305 406 300 113	-06/14 für Fzg. ohne Vorrüstung	S	CAN	C	E	D	L1	V	150
												305 407 300 113	06/14-07/19 für Fzg. mit Vorrüstung	S	CAN	C	E	D	L	H	30
												305 408 300 107	→ 06/14-07/19 für Fzg. ohne Vorrüstung	S	CAN	C	E	--	--	V	60
												305 408 300 113	06/14-07/19 für Fzg. ohne Vorrüstung	S	CAN	C	E	D	L	V	60















Volkswagen

VW Golf VII Limousine (AU) für Fzg. ohne Vorrüstung nicht für e-Golf, GTI TCR, GTI Clubsport	10/12-07/19	KIT		305 418 900 113		60	20.9	10.3	85	2000		im KIT enthalten 305 438 300 113		inkl. WLC 2.0 für Fzg. ohne Vorrüstung	S	CAN	C	E	D	L1	V	90
VW Golf VII Limousine (AU) für Fzg. ohne Vorrüstung nicht für e-Golf, GTI TCR, GTI Clubsport Spoiler inkl. Abdeckklappe bitte beim VW-Händler bestellen.	10/12-07/19	KIT		305 419 900 113		60	20.9	10.3	85	2000		im KIT enthalten 305 438 300 113		inkl. WLC 2.0 für Fzg. ohne Vorrüstung	S	CAN	C	E	D	L1	V	90
VW Golf VII Limousine (AU) für Fzg. ohne Vorrüstung nicht für e-Golf, GTI TCR, GTI Clubsport	06/14-07/19	KIT		305 408 900 113		60	19.0	10.3	85	2000		im KIT enthalten 305 408 300 113		06/14-07/19 für Fzg. ohne Vorrüstung	S	CAN	C	E	D	L	V	60
VW Golf VII Limousine (AU) für Fzg. ohne Vorrüstung nicht für e-Golf, GTI TCR, GTI Clubsport Spoiler inkl. Abdeckklappe bitte beim VW-Händler bestellen.	06/14-07/19	KIT		305 409 900 113		60	21.0	10.3	85	2000		im KIT enthalten 305 408 300 113		06/14-07/19 für Fzg. ohne Vorrüstung	S	CAN	C	E	D	L	V	60
VW Golf VII Limousine (AU) für Fzg. mit Vorrüstung nicht für e-Golf, GTI TCR, GTI Clubsport Spoiler inkl. Abdeckklappe bitte beim VW-Händler bestellen.	06/14-07/19	KIT		317 155 900 113		60	20.5	10.3	85	2000		im KIT enthalten 305 407 300 113		06/14-07/19 für Fzg. mit Vorrüstung	S	CAN	C	E	D	L	H	30
VW Golf VII Limousine (AU) für Fzg. mit Vorrüstung nicht für e-Golf, GTI TCR, GTI Clubsport	06/14-07/19	KIT		317 154 900 113		60	20.5	10.3	85	2000		im KIT enthalten 305 407 300 113		06/14-07/19 für Fzg. mit Vorrüstung	S	CAN	C	E	D	L	H	30
VW Golf VII Sportsvan AM1	06/14-06/20			317 131 600 001		60	19.0	10.3	85	2000		305 407 300 113		für Fzg. mit Vorrüstung	S	CAN	C	E	D	L	H	30
												305 408 300 107	→	für Fzg. ohne Vorrüstung	S	CAN	C	E	--	--	V	60
												305 408 300 113		für Fahrzeuge ohne Vorrüstung	S	CAN	C	E	D	L	V	60

VW Golf VII Sportsvan AM1 Spoiler inkl. Abdeckklappe bitte beim VW-Händler bestellen.	06/14-06/20		317 132 600 001		60	19.0	10.3	85	2000	305 407 300 113	→	für Fzg. mit Vorrüstung	S	CAN	C	E	D	L	H	30	
												305 408 300 107	für Fzg. ohne Vorrüstung	S	CAN	C	E	--	--	V	60
												305 408 300 113	für Fahrzeuge ohne Vorrüstung	S	CAN	C	E	D	L	V	60
VW Golf VII Sportsvan AM1 für Fzg. ohne Vorrüstung	06/14-06/20	KIT 	305 408 900 113		60	19.0	10.3	85	2000	im KIT enthalten 305 408 300 113		für Fahrzeuge ohne Vorrüstung	S	CAN	C	E	D	L	V	60	
												305 418 900 113	inkl. WLC 2.0 für Fzg. ohne Vorrüstung	S	CAN	C	E	D	L1	V	90
VW Golf VII Sportsvan AM1 für Fzg. ohne Vorrüstung Spoiler inkl. Abdeckklappe bitte beim VW-Händler bestellen.	06/14-06/20	KIT 	305 409 900 113		60	21.0	10.3	85	2000	im KIT enthalten 305 408 300 113		für Fahrzeuge ohne Vorrüstung	S	CAN	C	E	D	L	V	60	
												305 419 900 113	inkl. WLC 2.0 für Fzg. ohne Vorrüstung	S	CAN	C	E	D	L1	V	90
VW Golf VII Sportsvan AM1 für Fzg. mit Vorrüstung Spoiler inkl. Abdeckklappe bitte beim VW-Händler bestellen.	06/14-06/20	KIT 	317 155 900 113		60	20.5	10.3	85	2000	im KIT enthalten 305 407 300 113		für Fzg. mit Vorrüstung	S	CAN	C	E	D	L	H	30	
VW Golf VII Sportsvan AM1 für Fzg. mit Vorrüstung	06/14-06/20	KIT 	317 154 900 113		60	20.5	10.3	85	2000	im KIT enthalten 305 407 300 113		für Fzg. mit Vorrüstung	S	CAN	C	E	D	L	H	30	
VW Golf VII Variant			321 782 600 001		60	17.0	10.2	80	2000												
VW Golf VII Variant für Fzg. ohne Vorrüstung auch für 4-Motion	08/13-06/14	KIT 	321 781 900 113		60	18.0	10.2	80	2000	im KIT enthalten 305 406 300 113		-06/14für Fzg. ohne Vorrüstung	S	CAN	C	E	D	L1	V	150	
												321 782 900 113		60	19.0	10.2	80	2000	im KIT enthalten 305 406 300 113	-06/14für Fzg. ohne Vorrüstung	S





















Volkswagen

























VW Golf VII Variant auch für 4-Motion auch für Alltrack 02/15-	08/13-08/20		321 781 600 001		60	16.0	10.2	80	2000	305 403 300 113		-06/14 für Fzg. mit Vorrüstung	S	CAN	C	E	D	L1	H	45					
						321 782 600 001		60	17.0			10.2	80	2000	305 406 300 113		-06/14 für Fzg. ohne Vorrüstung	S	CAN	C	E	D	L1	V	150
								305 407 300 113	305 408 300 107			305 408 300 113	→	06/14- für Fzg. mit Vorrüstung			S	CAN	C	E	D	L	H	30	
														06/14- für Fzg. ohne Vorrüstung			S	CAN	C	E	--	--	V	60	
														06/14- für Fzg. ohne Vorrüstung			S	CAN	C	E	D	L	V	60	
VW Golf VII Variant für Fzg. ohne Vorrüstung auch für 4-Motion auch für Alltrack 02/15-	08/13-08/20	KIT 	321 787 900 113		60	17.9	10.2	80	2000	im KIT enthalten 305 438 300 113		inkl. WLC 2.0 für Fzg. ohne Vorrüstung	S	CAN	C	E	D	L1	V	90					
					KIT 	321 786 900 113		60	18.9			10.2	80	2000	im KIT enthalten 305 438 300 113		inkl. WLC 2.0 für Fzg. ohne Vorrüstung	S	CAN	C	E	D	L1	V	90
								VW Golf VII Variant für Fzg. ohne Vorrüstung auch für 4-Motion auch für Alltrack 02/15-	06/14-08/20			KIT 	321 783 900 113				60	18.0	10.2	80	2000	im KIT enthalten 305 408 300 113		06/14- für Fzg. ohne Vorrüstung	S
KIT 	321 784 900 113		60	19.0	10.2	80	2000			im KIT enthalten 305 408 300 113					06/14- für Fzg. ohne Vorrüstung	S	CAN	C	E	D	L			V	60
			VW Golf VIII Limousine CD1 nicht für GTI Clubsport Modell Style: Bitte Spoiler wechseln. Bitte Halter für Antennenverstärker separat bestellen:917131631001	07/19-		317 131 600 001		60	19.0			10.3	85	2000	322 080 300 113		für Fzg. ohne Vorrüstung	S	CAN	C	E	D	L	V	120
	317 132 600 001							60	19.0	10.3	85	2000	322 081 300 113				für Fzg. mit Vorrüstung	S	CAN	C	E	D	L	H	45
			VW Golf VIII Limousine CD1 für Fzg. ohne Vorrüstung nicht für GTI Clubsport Modell Style: Bitte Spoiler wechseln. Bitte Halter für Antennenverstärker separat bestellen:917131631001	07/19-	KIT 	322 080 900 113		60	21.0	10.3	85	2000			im KIT enthalten 322 080 300 113		für Fzg. ohne Vorrüstung	S	CAN	C	E	D	L	V	120
KIT 	322 081 900 113							60	21.0	10.3	85	2000	im KIT enthalten 322 080 300 113				für Fzg. ohne Vorrüstung	S	CAN	C	E	D	L	V	120

VW Golf VIII Limousine CD1 auch für AdBlue auch für Hybrid nicht für GTI Clubsport nicht für R-Line Modell Style: Bitte Spoiler wechseln.	07/19-			322 093 600 001		60	17.7	12.3	150	2500		322 080 300 113	für Fzg. ohne Vorrüstung	S	CAN	C	E	D	L	V	120
				322 094 600 001		60	17.7	12.3	150	2500		322 081 300 113	für Fzg. mit Vorrüstung	S	CAN	C	E	D	L	H	45
VW Golf VIII Limousine CD1 für Fzg. ohne Vorrüstung auch für AdBlue auch für Hybrid nicht für GTI Clubsport nicht für R-Line Modell Style: Bitte Spoiler wechseln.	07/19-	KIT		322 093 900 113		60	19.6	12.3	150	2500		im KIT enthalten 322 080 300 113	für Fzg. ohne Vorrüstung	S	CAN	C	E	D	L	V	120
				322 094 900 113		60	19.6	12.3	150	2500		im KIT enthalten 322 080 300 113	für Fzg. ohne Vorrüstung	S	CAN	C	E	D	L	V	120
VW Golf VIII Variant CG5 für Fzg. ohne Vorrüstung auch für AdBlue auch für Hybrid	08/20-	KIT		322 093 900 113		60	19.6	12.3	150	2500		im KIT enthalten 322 080 300 113	für Fzg. ohne Vorrüstung	S	CAN	C	E	D	L	V	120
				322 094 900 113		60	19.6	12.3	150	2500		im KIT enthalten 322 080 300 113	für Fzg. ohne Vorrüstung	S	CAN	C	E	D	L	V	120
VW Golf VIII Variant CG5 auch für AdBlue auch für Hybrid	08/20-			322 093 600 001		60	17.7	12.3	150	2500		322 080 300 113	für Fzg. ohne Vorrüstung	S	CAN	C	E	D	L	V	120
				322 094 600 001		60	17.7	12.3	150	2500		322 081 300 113	für Fzg. mit Vorrüstung	S	CAN	C	E	D	L	H	45
VW ID.4 E21	05/20-			322 091 600 001		60	18.2	9.1	100	1400		322 090 300 113	05/20- für Fzg. ohne Vorrüstung	S	CAN	C	E	D	L	V	75
VW ID.5 E39	05/22-			322 091 600 001		60	18.2	9.1	100	1400											
VW ID. Buzz Kasten/Bus EBB,EBA	04/22-			322 134 600 001		90	23.1	11.5	100	1000		322 134 300 113		S	CAN	C	E	D	L	V	75
			KIT		322 134 900 113		90	25.2	11.5	100	1000		im KIT enthalten 322 134 300 113		S	CAN	C	E	D	L	V









Volkswagen

























Volkswagen

VW Jetta Bitte Spoiler beim VW-Händler bestellen.	08/05-12/10			321 630 600 001		90	17.0	9.3	100	1800		321 600 300 113				S	FRE	C	E	D	L1	V	105
		KIT		321 630 900 113		90	21.0	9.3	100	1800		im KIT enthalten 321 600 300 113				S	FRE	C	E	D	L1	V	105
VW Jetta	08/05-12/10			321 662 600 001		90	17.0	9.3	100	1800		321 600 300 113				S	FRE	C	E	D	L1	V	105
		KIT		321 662 900 113		90	19.0	9.3	100	1800		im KIT enthalten 321 600 300 113				S	FRE	C	E	D	L1	V	105
VW LT II Die Aufstellung zum VW LT II finden Sie im Anhang.	03/96-03/06																						
VW Passat CC auch für 4-Motion nicht für R36 Stoßfängerunterteil inkl. Abdeckklappe bitte beim VW-Händler bestellen.	03/05-12/12			321 546 600 001		90	17.5	11.3	90	2200		321 600 300 113				S	FRE	C	E	D	L1	V	105
		KIT		321 546 900 113		90	21.0	11.3	90	2200		im KIT enthalten 321 600 300 113				S	FRE	C	E	D	L1	V	105
VW Passat Limousine Frontantrieb nicht für 4-Motion Reserveradeinlage für sichere Unterbringung der abnehmbaren Kugelstange: 3B0 804 993A	10/96-03/05			321 505 600 001	→	90	20.8	10.3	85	1800													
VW Passat Limousine auch für 4-Motion nicht für R36	03/05-10/10			321 544 600 001		90	16.0	11.3	90	2200		321 600 300 113				S	FRE	C	E	D	L1	V	105
		KIT		321 544 900 113		90	18.0	12.3	90	2200		im KIT enthalten 321 600 300 113				S	FRE	C	E	D	L1	V	105
VW Passat Limousine auch für 4-Motion nicht für R36 Stoßfängerunterteil inkl. Abdeckklappe bitte beim VW-Händler bestellen.	03/05-10/10			321 546 600 001		90	17.5	11.3	90	2200		321 600 300 113				S	FRE	C	E	D	L1	V	105
		KIT		321 546 900 113		90	21.0	11.3	90	2200		im KIT enthalten 321 600 300 113				S	FRE	C	E	D	L1	V	105















VW Passat Limousine B7 R-Line = sichtbarer Ausschnitt	10/10-11/14			321 821 600 001		90	17.5	11.3	90	2200		321 600 300 113			S	FRE	C	E	D	L1	V	105
				321 823 600 001		90	20.0	11.3	90	2200												
		KIT		321 821 900 113		90	19.5	11.3	90	2200	im KIT enthalten 321 600 300 113			S	FRE	C	E	D	L1	V	105	
		KIT		321 823 900 113		90	22.0	11.3	90	2200	im KIT enthalten 321 600 300 113			S	FRE	C	E	D	L1	V	105	
VW Passat Limousine B8 für Fzg. mit Vorrüstung Bitte Halter für Antennenverstärker separat bestellen: 917131631001	11/14-	KIT		317 138 900 113		90	17.0	11.5	100	2200	im KIT enthalten 305 407 300 113		-12/21 für Fzg. mit Vorrüstung	S	CAN	C	E	D	L	H	30	
		KIT		317 139 900 113		90	17.5	11.5	100	2200	im KIT enthalten 305 407 300 113		-12/21 für Fzg. mit Vorrüstung	S	CAN	C	E	D	L	H	30	
VW Passat Limousine B8 Bitte Halter für Antennenverstärker separat bestellen: 917131631001	11/14-12/21			317 140 600 001		90	15.0	11.5	100	2200	305 407 300 113	→	-12/21 für Fzg. mit Vorrüstung	S	CAN	C	E	D	L	H	30	
				317 141 600 001		90	15.9	11.5	100	2200	305 408 300 107		-12/21 für Fzg. ohne Vorrüstung	S	CAN	C	E	--	--	V	60	
											305 408 300 113		-12/21 für Fzg. ohne Vorrüstung	S	CAN	C	E	D	L	V	60	
											305 438 300 113		-12/21 inkl. WLC 2.0 für Fzg. ohne Vorrüstung	S	CAN	C	E	D	L1	V	90	
VW Passat Limousine B8 für Fzg. ohne Vorrüstung Bitte Halter für Antennenverstärker separat bestellen: 917131631001	11/14-12/21	KIT		317 140 900 113		90	19.6	11.5	100	2200	im KIT enthalten 305 408 300 113		-12/21 für Fzg. ohne Vorrüstung	S	CAN	C	E	D	L	V	60	
		KIT		317 143 900 113		90	17.4	11.5	100	2200	im KIT enthalten 305 438 300 113		-12/21 inkl. WLC 2.0 für Fzg. ohne Vorrüstung	S	CAN	C	E	D	L1	V	90	
		KIT		317 141 900 113		90	19.9	11.5	100	2200	im KIT enthalten 305 408 300 113		-12/21 für Fzg. ohne Vorrüstung	S	CAN	C	E	D	L	V	60	
		KIT		317 142 900 113		90	17.8	11.5	100	2200	im KIT enthalten 305 438 300 113		-12/21 inkl. WLC 2.0 für Fzg. ohne Vorrüstung	S	CAN	C	E	D	L1	V	90	



















Volkswagen

<p>VW Passat Variant Frontantrieb nicht für 4-Motion Um den optimalen Sitz des Stoßfängers ab Bauj. 11/00 zu gewährleisten, empfehlen wir die Montage der Stoßfängerverstärkung VW-Nr. 3B9 807 251A, erhältlich beim VW-Partner. Reserveradeinlage für sichere Unterbringung der abnehmbaren Kugelstange: 3B0 804 993A</p>	04/97-09/05			<p>321 505 600 001 → </p>		90	20.8	10.3	85	1800		<p>321 520 300 113</p>		11/00-	S	FRE	--	E	D1	L1	V	60	
<p>VW Passat Variant Frontantrieb nicht für 4-Motion Um den optimalen Sitz des Stoßfängers ab Bauj. 11/00 zu gewährleisten, empfehlen wir die Montage der Stoßfängerverstärkung VW-Nr. 3B9 807 251A, erhältlich beim VW-Partner. Reserveradeinlage für sichere Unterbringung der abnehmbaren Kugelstange: 3B0 804 993A</p>	11/00-09/05	KIT		<p>321 505 900 113 → </p>		90	24.0	10.3	85	2000		<p>im KIT enthalten 321 520 300 113</p>		11/00-	S	FRE	--	E	D1	L1	V	60	
<p>VW Passat Variant auch für 4-Motion, auch für R36 08/05-: Für den optimalen Sitz des Stoßfängers die Stoßfängerverstärkung 3C9 807 251 A beim VW-Händler bestellen.</p>	09/05-10/10			<p>321 544 600 001</p>		90	16.0	11.3	90	2200		<p>321 600 300 113</p>			S	FRE	C	E	D	L1	V	105	
		KIT		<p>321 544 900 113</p>		90	18.0	12.3	90	2200		<p>im KIT enthalten 321 600 300 113</p>			S	FRE	C	E	D	L1	V	105	
		KIT		<p>321 546 900 113</p>		90	21.0	11.3	90	2200		<p>im KIT enthalten 321 600 300 113</p>			S	FRE	C	E	D	L1	V	105	













VW Passat Variant B7 auch für Alltrack R-Line = sichtbarer Ausschnitt	10/10-11/14			321 821 600 001		90	17.5	11.3	90	2200		321 600 300 113								S	FRE	C	E	D	L1	V	105	
				321 823 600 001		90	20.0	11.3	90	2200																		
		KIT		321 821 900 113		90	19.5	11.3	90	2200	im KIT enthalten 321 600 300 113																	
		KIT		321 823 900 113		90	22.0	11.3	90	2200	im KIT enthalten 321 600 300 113																	
VW Passat Variant B8 auch für Alltrack Für den optimalen Sitz des Stoßfängers die Stoßfängerverstärkung 3G9807863B beim VW-Händler bestellen. Bitte Halter für Antennenverstärker separat bestellen: 917131631001	11/14-			317 140 600 001		90	15.0	11.5	100	2200		305 407 300 113	→	für Fzg. mit Vorrüstung	S	CAN	C	E	D	L	H							30
				317 141 600 001		90	15.9	11.5	100	2200		305 408 300 107		für Fzg. ohne Vorrüstung	S	CAN	C	E	--	--			V					60
												305 408 300 113		für Fzg. ohne Vorrüstung	S	CAN	C	E	D	L	V							60
												305 438 300 113		inkl. WLC 2.0 für Fzg. ohne Vorrüstung	S	CAN	C	E	D	L1	V							90
VW Passat Variant B8 für Fzg. ohne Vorrüstung auch für Alltrack Für den optimalen Sitz des Stoßfängers die Stoßfängerverstärkung 3G9807863B beim VW-Händler bestellen. Bitte Halter für Antennenverstärker separat bestellen: 917131631001	11/14-	KIT		317 140 900 113		90	19.6	11.5	100	2200		im KIT enthalten 305 408 300 113		für Fzg. ohne Vorrüstung	S	CAN	C	E	D	L	V						60	
		KIT		317 143 900 113		90	17.4	11.5	100	2200		im KIT enthalten 305 438 300 113		inkl. WLC 2.0 für Fzg. ohne Vorrüstung	S	CAN	C	E	D	L1	V					90		
		KIT		317 141 900 113		90	19.9	11.5	100	2200		im KIT enthalten 305 408 300 113		für Fzg. ohne Vorrüstung	S	CAN	C	E	D	L	V					60		
		KIT		317 142 900 113		90	17.8	11.5	100	2200		im KIT enthalten 305 438 300 113		inkl. WLC 2.0 für Fzg. ohne Vorrüstung	S	CAN	C	E	D	L1	V					90		
VW Passat Variant B8 für Fzg. mit Vorrüstung auch für Alltrack Für den optimalen Sitz des Stoßfängers die Stoßfängerverstärkung 3G9807863B beim VW-Händler bestellen. Bitte Halter für Antennenverstärker separat bestellen: 917131631001	11/14-	KIT		317 138 900 113		90	17.0	11.5	100	2200		im KIT enthalten 305 407 300 113		für Fzg. mit Vorrüstung	S	CAN	C	E	D	L	H					30		
		KIT		317 139 900 113		90	17.5	11.5	100	2200		im KIT enthalten 305 407 300 113		für Fzg. mit Vorrüstung	S	CAN	C	E	D	L	H					30		









Volkswagen

VW Phaeton Bitte beim VW-Händler bestellen: Spoiler V6 Benzin + V 8: 3D5 807 434 F Spoiler V6 Diesel + V10: 3D5 807 434 H Spoiler: V12: 3D5 807 434 G Stoßfänger-Abdeckung: 3D5 807 397 A V7S Klammer (2x): 6Q0 807 180 Halterung für Kugelstange im Kofferraum, bestehend aus: Halterung: 3D5 863 503 Aufnahme für Kugelkopf: 3D5 804 969 A Montageteile: 3D5 807 996 Deckel rechts: 3D5 868 886 A	05/02-01/16			321 525 600 001		90	26.0	13.6	100	2500		321 495 300 113		11/08-	S	CAN	C	E	D	L1	H	60	
VW Polo auch für R-Line Falls aus optischen Gründen erwünscht, kann bei VW ein kpl. Stoßfänger inkl. Abdeckkappe bestellt werden. R-Line: Verlängerung für Steckdosenhalter erforderlich, Art.-Nr. 921740650001	06/09-04/14	KIT		321 741 900 113		120	17.0	7.0	50	1200		im KIT enthalten 321 527 300 113		-04/14	S	CAN	C	E	D1	L1	V	105	
VW Polo auch für R-Line Falls aus optischen Gründen erwünscht, kann bei VW ein kpl. Stoßfänger inkl. Abdeckkappe bestellt werden. R-Line: Verlängerung für Steckdosenhalter erforderlich, Art.-Nr. 921740650001	06/09-04/14	KIT		321 748 900 113		120	18.5	7.0	50	1200		im KIT enthalten 321 527 300 113		-04/14	S	CAN	C	E	D1	L1	V	105	
VW Polo auch für R-Line Falls aus optischen Gründen erwünscht, kann bei VW ein kpl. Stoßfänger inkl. Abdeckkappe bestellt werden. R-Line: Verlängerung für Steckdosenhalter erforderlich, Art.-Nr. 921740650001	06/09-07/17		 	321 832 600 001 321 878 600 001	 	120	14.5	7.0	50	1200		321 527 300 113 321 529 300 113	-04/14 04/14-07/17	S S	CAN CAN	C C	E E	D1 D1	L1 L1	V V	105		
VW Polo auch für R-Line Falls aus optischen Gründen erwünscht, kann bei VW ein kpl. Stoßfänger inkl. Abdeckkappe bestellt werden. R-Line: Verlängerung für Steckdosenhalter erforderlich, Art.-Nr. 921740650001	04/14-07/17	KIT KIT	 	321 832 900 113 321 878 900 113	 	120	16.5	7.0	50	1200		im KIT enthalten 321 529 300 113 im KIT enthalten 321 529 300 113	04/14-07/17 04/14-07/17	S S	CAN CAN	C C	E E	D1 D1	L1 L1	V V			





























VW Polo Bluemotion Bitte prüfen, ob Anhängelast in den Fahrzeugpapieren eingetragen ist. Verlängerung für Steckdosenhalter erforderlich, Art.-Nr. 921740650001	06/09-04/14	KIT		321 741 900 113		120	17.0	7.0	50	1200		im KIT enthalten 321 527 300 113	-04/14	S	CAN	C	E	D1	L1	V	105
VW Polo Bluemotion Verlängerung für Steckdosenhalter erforderlich, Art.-Nr. 921740650001. Bitte prüfen, ob Anhängelast in den Fahrzeugpapieren eingetragen ist.	06/09-04/14	KIT		321 748 900 113		120	18.5	7.0	50	1200		im KIT enthalten 321 527 300 113	-04/14	S	CAN	C	E	D1	L1	V	105
VW Polo Bluemotion Bitte prüfen, ob Anhängelast in den Fahrzeugpapieren eingetragen ist.	06/09-07/17			321 832 600 001		120	14.5	7.0	50	1200		321 527 300 113 321 529 300 113	-04/14 04/14-07/17	S S	CAN CAN	C C	E E	D1 D1	L1 L1	V V	105
VW Polo Bluemotion Verlängerung für Steckdosenhalter erforderlich, Art.-Nr. 921740650001. Bitte prüfen, ob Anhängelast in den Fahrzeugpapieren eingetragen ist.	06/09-07/17			321 878 600 001		120	16.5	7.0	50	1200		321 527 300 113 321 529 300 113	-04/14 04/14-07/17	S S	CAN CAN	C C	E E	D1 D1	L1 L1	V V	105
VW Polo Bluemotion Bitte prüfen, ob Anhängelast in den Fahrzeugpapieren eingetragen ist. Verlängerung für Steckdosenhalter erforderlich, Art.-Nr. 921740650001	04/14-07/17	KIT		321 832 900 113		120	16.5	7.0	50	1200		im KIT enthalten 321 529 300 113	04/14-07/17	S	CAN	C	E	D1	L1	V	
VW Polo Bluemotion Verlängerung für Steckdosenhalter erforderlich, Art.-Nr. 921740650001. Bitte prüfen, ob Anhängelast in den Fahrzeugpapieren eingetragen ist.	04/14-07/17	KIT		321 878 900 113		120	18.5	7.0	50	1200		im KIT enthalten 321 529 300 113	04/14-07/17	S	CAN	C	E	D1	L1	V	
VW Polo Cross Bitte Abdeckklappe beim VW-Händler bestellen.	02/06-06/09			321 523 600 001		90	16.0	7.0	50	1200		321 524 300 113		S	C2	C	E	D1	L1	H	45
		KIT		321 523 900 113		90	18.0	7.0	50	1200		im KIT enthalten 321 524 300 113		S	C2	C	E	D1	L1	H	45
VW Polo Cross Verlängerung für Steckdosenhalter erforderlich, Art.-Nr. 921740650001	06/09-04/14	KIT		321 741 900 113		120	17.0	7.0	50	1200		im KIT enthalten 321 527 300 113	-04/14	S	CAN	C	E	D1	L1	V	105











Volkswagen

VW Polo Cross Bitte Spoiler beim VW-Händler bestellen. Verlängerung für Steckdosenhalter erforderlich, Art.-Nr. 921740650001	06/09-04/14	KIT		321 748 900 113		120	18.5	7.0	50	1200		im KIT enthalten 321 527 300 113	-04/14	S	CAN	C	E	D1	L1	V	105
VW Polo Cross Verlängerung für Steckdosenhalter erforderlich, Art.-Nr. 921740650001	06/09-04/14			321 832 600 001		120	14.5	7.0	50	1200		321 527 300 113	-04/14	S	CAN	C	E	D1	L1	V	105
VW Polo Cross Bitte Spoiler beim VW-Händler bestellen. Verlängerung für Steckdosenhalter erforderlich, Art.-Nr. 921740650001	06/09-04/14			321 878 600 001		120	16.5	7.0	50	1200		321 527 300 113	-04/14	S	CAN	C	E	D1	L1	V	105
VW Polo Fun Sonderfreigabe durch VW erforderlich.	04-09			321 523 600 001		90	16.0	7.0	50	1200		321 524 300 113		S	C2	C	E	D1	L1	H	45
		KIT		321 523 900 113		90	18.0	7.0	50	1200		im KIT enthalten 321 524 300 113		S	C2	C	E	D1	L1	H	45
VW Polo Gti Verlängerung für Steckdosenhalter erforderlich, Art.-Nr. 921740650001	06/09-04/14	KIT		321 741 900 113		120	17.0	7.0	50	1200		im KIT enthalten 321 527 300 113	-04/14	S	CAN	C	E	D1	L1	V	105
VW Polo Gti Bitte Abdeckklappe beim VW-Händler bestellen. Verlängerung für Steckdosenhalter erforderlich, Art.-Nr. 921740650001	06/09-04/14	KIT		321 748 900 113		120	18.5	7.0	50	1200		im KIT enthalten 321 527 300 113	-04/14	S	CAN	C	E	D1	L1	V	105
VW Polo Gti Verlängerung für Steckdosenhalter erforderlich, Art.-Nr. 921740650001	06/09-04/14			321 832 600 001		120	14.5	7.0	50	1200		321 527 300 113	-04/14	S	CAN	C	E	D1	L1	V	105
VW Polo Gti Bitte Abdeckklappe beim VW-Händler bestellen. Verlängerung für Steckdosenhalter erforderlich, Art.-Nr. 921740650001	06/09-04/14			321 878 600 001		120	16.5	7.0	50	1200		321 527 300 113	-04/14	S	CAN	C	E	D1	L1	V	105













VW Polo Steilheck für Polo Fun mit Sonderfreigabe durch VW nicht für GTi / 150 PS auch für Facelift ab 05/05, Blue Motion Für die Abdeckung (bei demontierter Kugelstange) bitte folgende Teile beim VW-Händler erwerben: 1 Spoiler 6Q6 807 433 B41 1 Deckel 6Q6 807 397 B41 2 Bolzen 6Q6 807 643 2 Federklammern 6Q6 807 180 2 Scheiben 6N0 129 355	11/01-08/09			321 523 600 001		90	16.0	7.0	50	1200		321 523 300 113	-05/05	S	C2	C	E	D1	L1	H	45
												321 524 300 113	05/05-	S	C2	C	E	D1	L1	H	45
VW Polo Steilheck für Polo Fun mit Sonderfreigabe durch VW nicht für GTi / 150 PS auch für Facelift ab 05/05, Blue Motion Für die Abdeckung (bei demontierter Kugelstange) bitte folgende Teile beim VW-Händler erwerben: 1 Spoiler 6Q6 807 433 B41 1 Deckel 6Q6 807 397 B41 2 Bolzen 6Q6 807 643 2 Federklammern 6Q6 807 180 2 Scheiben 6N0 129 355	05/05-09	KIT		321 523 900 113		90	18.0	7.0	50	1200		im KIT enthalten 321 524 300 113	05/05-	S	C2	C	E	D1	L1	H	45
VW Polo VI (AW1) nicht für GTI, nicht für R-Line, nicht für TGI nicht für Facelift	06/17-06/21			344 123 600 001		60	18.0	7.5	91	1270		344 110 300 113		S	CAN	C	E	D	L	V	60
		KIT		344 122 900 113		60	19.0	7.5	91	1270		im KIT enthalten 344 110 300 113		S	CAN	C	E	D	L	V	60
		KIT		344 123 900 113		60	20.0	7.5	91	1270		im KIT enthalten 344 110 300 113		S	CAN	C	E	D	L	V	60
VW Polo VI (AW1) nicht für GTI, nicht für R-Line, nicht für TGI nicht für Facelift	06/17-06/21			344 122 600 001		60	17.0	7.5	91	1270		344 110 300 113		S	CAN	C	E	D	L	V	60





















Volkswagen

VW Polo VI AW1 für Facelift nicht für GTI nicht für R-Line nicht für TGI	06/21-		322 112 600 001		75	17.0	7.8	95	1200	344 110 300 113				S	CAN	C	E	D	L	V	60	
			322 113 600 001		75	18.0	7.8	95	1200													
	KIT		322 112 900 113		75	19.0	7.8	95	1200	im KIT enthalten 344 110 300 113					S	CAN	C	E	D	L	V	60
	KIT		322 113 900 113		75	20.0	7.8	95	1200	im KIT enthalten 344 110 300 113					S	CAN	C	E	D	L	V	60
VW Sharan inkl. Wärmeschutzblech auch 4WD Stoßfängerträger nicht erforderlich. Bei 4-Motion bitte Hinweise des Kfz.-Herstellers beachten.	05/00-08/10		321 665 600 001		90	24.0	12.5	100	2500	321 458 300 113				S	FRE	--	E	D1	L1	H	60	
		KIT		321 665 900 113		90	26.0	12.5	100	2500	im KIT enthalten 321 458 300 113				S	FRE	--	E	D1	L1	H	60
VW Sharan	09/10-03/22		321 698 600 001			22.0	12.3	100	2500	321 600 300 113	-03/22			S	FRE	C	E	D	L1	V	105	
		KIT		321 698 900 113			24.0	12.3	100	2500	im KIT enthalten 321 600 300 113	-03/22			S	FRE	C	E	D	L1	V	105
VW Sharan Bitte Spoiler und Klappe für Stoßfängerauschnitt beim VW- Händler bestellen.	09/10-03/22		321 700 600 001			22.0	12.3	100	2500	321 600 300 113	-03/22			S	FRE	C	E	D	L1	V	105	
		KIT		321 700 900 113			24.0	12.3	100	2500	im KIT enthalten 321 600 300 113	-03/22			S	FRE	C	E	D	L1	V	105
VW T-Cross (C11) nicht für R-Line	12/18-		322 075 600 001		60	19.3	7.9	70	1400	344 110 300 113				S	CAN	C	E	D	L	V	60	
			322 076 600 001		60	20.6	7.9	70	1400													
	KIT		322 075 900 113		60	21.4	7.9	70	1400	im KIT enthalten 344 110 300 113				S	CAN	C	E	D	L	V	60	
	KIT		322 076 900 113		60	22.7	7.9	70	1400	im KIT enthalten 344 110 300 113				S	CAN	C	E	D	L	V	60	

VW T-Roc A11 Bitte Halter für Antennenverstärker separat bestellen:917131631001 für Fzg. 07/17-12/21: Bitte Steckdosenverlängerung 921740650001 zusätzlich bestellen. auch für Facelift 01/22-	07/17-		317 132 600 001		60	19.0	10.3	85	2000		305 407 300 113	→	für Fzg. mit Vorrüstung	S	CAN	C	E	D	L	H	30
										305 408 300 107	für Fzg. ohne Vorrüstung		S	CAN	C	E	--	--	V	60	
										305 408 300 113	für Fzg. ohne Vorrüstung		S	CAN	C	E	D	L	V	60	
										305 438 300 113	inkl. WLC 2.0 für Fzg. ohne Vorrüstung		S	CAN	C	E	D	L1	V	90	
VW T-Roc A11 für Fzg. ohne Vorrüstung Bitte Halter für Antennenverstärker separat bestellen:917131631001 für Fzg. 07/17-12/21: Bitte Steckdosenverlängerung 921740650001 zusätzlich bestellen. auch für Facelift 01/22-	07/17-	KIT 	305 409 900 113		60	21.0	10.3	85	2000		im KIT enthalten 305 408 300 113	→	für Fzg. ohne Vorrüstung	S	CAN	C	E	D	L	V	60
										305 419 900 113	inkl. WLC 2.0 für Fzg. ohne Vorrüstung		S	CAN	C	E	D	L1	V	90	
VW T-Roc A11 Bitte Halter für Antennenverstärker separat bestellen:917131631001 auch für Facelift 01/22-	07/17-		317 131 600 001		60	19.0	10.3	85	2000		305 407 300 113	→	für Fzg. mit Vorrüstung	S	CAN	C	E	D	L	H	30
										305 408 300 107	für Fzg. ohne Vorrüstung		S	CAN	C	E	--	--	V	60	
										305 408 300 113	für Fzg. ohne Vorrüstung		S	CAN	C	E	D	L	V	60	
										305 438 300 113	inkl. WLC 2.0 für Fzg. ohne Vorrüstung		S	CAN	C	E	D	L1	V	90	
VW T-Roc A11 für Fzg. ohne Vorrüstung Bitte Halter für Antennenverstärker separat bestellen:917131631001 auch für Facelift 01/22-	07/17-	KIT 	305 408 900 113		60	19.0	10.3	85	2000		im KIT enthalten 305 408 300 113	→	für Fzg. ohne Vorrüstung	S	CAN	C	E	D	L	V	60
										305 418 900 113	inkl. WLC 2.0 für Fzg. ohne Vorrüstung		S	CAN	C	E	D	L1	V	90	
VW T-Roc A11 für Fzg. mit Vorrüstung Bitte Halter für Antennenverstärker separat bestellen:917131631001 auch für Facelift 01/22-	07/17-	KIT 	317 154 900 113		60	20.5	10.3	85	2000		im KIT enthalten 305 407 300 113	→	für Fzg. mit Vorrüstung	S	CAN	C	E	D	L	H	30











Volkswagen













VW T-Roc A11 für Fzg. mit Vorrüstung Bitte Halter für Antennenverstärker separat bestellen:917131631001 für Fzg. 07/17-12/21: Bitte Steckdosenverlängerung 921740650001 zusätzlich bestellen. auch für Facelift 01/22-	07/17-	KIT		317 155 900 113		60	20.5	10.3	85	2000		im KIT enthalten 305 407 300 113	für Fzg. mit Vorrüstung	S	CAN	C	E	D	L	H	30
VW T-Roc Cabrio Bitte Halter für Antennenverstärker separat bestellen:917131631001	12/19-			317 131 600 001		60	19.0	10.3	85	2000		305 407 300 113	für Fzg. mit Vorrüstung	S	CAN	C	E	D	L	H	30
												305 408 300 107	→ für Fzg. ohne Vorrüstung	S	CAN	C	E	--	--	V	60
												305 408 300 113	für Fzg. ohne Vorrüstung	S	CAN	C	E	D	L	V	60
												305 438 300 113	inkl. WLC 2.0 für Fzg. ohne Vorrüstung	S	CAN	C	E	D	L1	V	90
VW T-Roc Cabrio Bitte Halter für Antennenverstärker separat bestellen:917131631001 Bitte Steckdosenverlängerung 921740650001 zusätzlich bestellen.	12/19-			317 132 600 001		60	19.0	10.3	85	2000		305 407 300 113	für Fzg. mit Vorrüstung	S	CAN	C	E	D	L	H	30
												305 408 300 107	→ für Fzg. ohne Vorrüstung	S	CAN	C	E	--	--	V	60
												305 408 300 113	für Fzg. ohne Vorrüstung	S	CAN	C	E	D	L	V	60
												305 438 300 113	inkl. WLC 2.0 für Fzg. ohne Vorrüstung	S	CAN	C	E	D	L1	V	90
VW T-Roc Cabrio für Fzg. ohne Vorrüstung Bitte Halter für Antennenverstärker separat bestellen:917131631001	12/19-	KIT		305 408 900 113		60	19.0	10.3	85	2000		im KIT enthalten 305 408 300 113	für Fzg. ohne Vorrüstung	S	CAN	C	E	D	L	V	60
		KIT		305 418 900 113		60	20.9	10.3	85	2000		im KIT enthalten 305 438 300 113	inkl. WLC 2.0 für Fzg. ohne Vorrüstung	S	CAN	C	E	D	L1	V	90
VW T-Roc Cabrio für Fzg. mit Vorrüstung Bitte Halter für Antennenverstärker separat bestellen:917131631001	12/19-	KIT		317 154 900 113		60	20.5	10.3	85	2000		im KIT enthalten 305 407 300 113	für Fzg. mit Vorrüstung	S	CAN	C	E	D	L	H	30

VW T-Roc Cabrio für Fzg. ohne Vorrüstung Bitte Halter für Antennenverstärker separat bestellen:917131631001 Bitte Steckdosenverlängerung 921740650001 zusätzlich bestellen.	12/19-	KIT		305 409 900 113		60	21.0	10.3	85	2000		im KIT enthalten 305 408 300 113	für Fzg. ohne Vorrüstung	S	CAN	C	E	D	L	V	60
		KIT		305 419 900 113		60	20.9	10.3	85	2000		im KIT enthalten 305 438 300 113	inkl. WLC 2.0 für Fzg. ohne Vorrüstung	S	CAN	C	E	D	L1	V	90
VW T-Roc Cabrio für Fzg. mit Vorrüstung Bitte Halter für Antennenverstärker separat bestellen:917131631001 Bitte Steckdosenverlängerung 921740650001 zusätzlich bestellen.	12/19-	KIT		317 155 900 113		60	20.5	10.3	85	2000		im KIT enthalten 305 407 300 113	für Fzg. mit Vorrüstung	S	CAN	C	E	D	L	H	30
VW T7 Multivan STM, STN auch für Plugin-Hybrid	08/21-			322 100 600 001		90	18.7	11.5	140	2000		322 100 300 113	08/21- auch für Plugin-Hybrid	S	CAN	C	E	D1	L1	V	90
				322 101 600 001		90	18.7	11.5	140	2000											
		KIT		322 100 900 113		90	20.7	11.5	140	2000		im KIT enthalten 322 100 300 113	08/21- auch für Plugin-Hybrid	S	CAN	C	E	D1	L1	V	90
		KIT		322 101 900 113		90	20.7	11.5	140	2000		im KIT enthalten 322 100 300 113	08/21- auch für Plugin-Hybrid	S	CAN	C	E	D1	L1	V	90
VW Taigo CS1 auch für R-Line	09/21-			322 111 600 001		90	20.0	7.5	90	1200		344 110 300 113	09/21-	S	CAN	C	E	D	L	V	60
		KIT		322 111 900 113		90	22.1	7.5	90	1200		im KIT enthalten 344 110 300 113	09/21-	S	CAN	C	E	D	L	V	60
VW Tiguan	11/07-03/16			305 421 600 001		90	19.0	12.0	100	2500		321 600 300 113		S	FRE	C	E	D	L1	V	105
				305 423 600 001		90	21.0	12.0	140	2500											
		KIT		321 727 900 113		90	21.0	12.0	100	2500		im KIT enthalten 321 600 300 113		S	FRE	C	E	D	L1	V	105
		KIT		321 728 900 113		90	23.0	12.0	100	2500		im KIT enthalten 321 600 300 113		S	FRE	C	E	D	L1	V	105



















Volkswagen



Volkswagen

VW Tiguan II (AD1) Bitte Halter für Antennenverstärker separat bestellen:917131631001	04/16-08/23			321 906 600 001		60	16.0	12.6	100	2500		305 407 300 113		für Fzg. mit Vorrüstung	S	CAN	C	E	D	L	H	30
				321 907 600 001		60	17.8	12.6	100	2500		305 408 300 107		für Fzg. ohne Vorrüstung	S	CAN	C	E	--	--	V	60
												305 408 300 113		04/16-08/23 für Fzg. ohne Vorrüstung	S	CAN	C	E	D	L	V	60
												305 438 300 113		04/16-08/23 inkl. WLC 2.0 für Fzg. ohne Vorrüstung	S	CAN	C	E	D	L1	V	90
VW Tiguan II (AD1) für Fzg. ohne Vorrüstung Bitte Halter für Antennenverstärker separat bestellen:917131631001	04/16-08/23	KIT		321 906 900 113		60	17.3	12.6	100	2500		im KIT enthalten 305 408 300 113		04/16-08/23 für Fzg. ohne Vorrüstung	S	CAN	C	E	D	L	V	60
				321 911 900 113		60	20.3	12.6	2500	2500		im KIT enthalten 305 438 300 113		04/16-08/23 inkl. WLC 2.0 für Fzg. ohne Vorrüstung	S	CAN	C	E	D	L1	V	90
				321 907 900 113		60	19.1	12.6	100	2500		im KIT enthalten 305 408 300 113		04/16-08/23 für Fzg. ohne Vorrüstung	S	CAN	C	E	D	L	V	60
				321 910 900 113		60	19.7	12.6	100	2500		im KIT enthalten 305 438 300 113		04/16-08/23 inkl. WLC 2.0 für Fzg. ohne Vorrüstung	S	CAN	C	E	D	L1	V	90
VW Tiguan II (AD1) für Fzg. ohne Vorrüstung	04/16-08/23	KIT		322 096 900 113		90	31.5	12.4	150	2500		im KIT enthalten 322 096 300 153		nicht einzeln lieferbar	S							
VW Touareg nicht für Fahrzeuge mit Reserverad auf der Heckklappe Um ein optimales Erscheinungsbild des Fahrzeuges zu erreichen, ist es erforderlich, den hinteren, unteren Spoiler sowie die Abdeckkappe (je nach Ausstattung des Fahrzeuges) separat beim VW-Händler zu bestellen (siehe Original-Katalog (ETKA) Bildtafel 806-50). Bei Fahrzeugen -04/10 bitte Schaumträger bei VW bestellen.	11/02-04/10	KIT		321 500 900 113		150	36.0	16.4	140	3500		im KIT enthalten 321 500 300 113		-04/10	S	CAN	--	E	D	L1	H	45

VW Touareg nicht für Fahrzeuge mit Reserverad auf der Heckklappe Um ein optimales Erscheinungsbild des Fahrzeuges zu erreichen, ist es erforderlich, den hinteren, unteren Spoiler sowie die Abdeckkappe (je nach Ausstattung des Fahrzeuges) separat beim VW-Händler zu bestellen (siehe Original-Katalog (ETKA) Bildtafel 806-50). Bei Fahrzeugen -04/10 bitte Schaumträger bei VW bestellen.	11/02-10/17			321 735 600 001		150	33.5	16.4	140	3500		321 500 300 113	→	-04/10	S	CAN	--	E	D	L1	H	45
				321 736 600 001		150	34.0	16.4	140	3500		321 765 300 113		04/10-08/14 nicht für Kfz. mit ACC / Distanzregulierung	S	CAN	C	E	D	L1	V	180
													321 766 300 113		08/14-10/17	S	CAN	C	E	D	L	H
VW Touareg nicht für Fahrzeuge mit Reserverad auf der Heckklappe Um ein optimales Erscheinungsbild des Fahrzeuges zu erreichen, ist es erforderlich, den hinteren, unteren Spoiler sowie die Abdeckkappe (je nach Ausstattung des Fahrzeuges) separat beim VW-Händler zu bestellen (siehe Original-Katalog (ETKA) Bildtafel 806-50). Bei Fahrzeugen -04/10 bitte Schaumträger bei VW bestellen.	04/10-08/14	KIT		321 736 900 113		150	36.0	16.4	140	3500		im KIT enthalten 321 765 300 113		04/10-08/14 nicht für Kfz. mit ACC / Distanzregulierung	S	CAN	C	E	D	L1	V	180
VW Touareg nicht für Fahrzeuge mit Reserverad auf der Heckklappe Um ein optimales Erscheinungsbild des Fahrzeuges zu erreichen, ist es erforderlich, den hinteren, unteren Spoiler sowie die Abdeckkappe (je nach Ausstattung des Fahrzeuges) separat beim VW-Händler zu bestellen (siehe Original-Katalog (ETKA) Bildtafel 806-50). Bei Fahrzeugen -04/10 bitte Schaumträger bei VW bestellen.	08/14-10/17	KIT		321 766 900 113			36.0	16.4	140	3500		im KIT enthalten 321 766 300 113		08/14-10/17	S	CAN	C	E	D	L	H	
VW Touareg CR7	11/17-			322 064 600 001		60	27.0	15.7	191	3500		305 417 300 113	→		S	A	C1	E2	D	L1	H	60
												305 437 300 113			S	CAN	C	E	D	L	H	60
												305 447 300 113			S	CAN	C	E	D	L1	H	60
VW Touareg	11/17-	KIT		322 064 900 113		60	28.0	15.7	191	3500		im KIT enthalten 305 437 300 113			S	CAN	C	E	D	L	H	60



Volkswagen

VW Touran auch für Cross-Touran	03/03-09/15			321 536 600 001		90	19.5	9.9	75	1800		321 600 300 113			S	FRE	C	E	D	L1	V	105	
		KIT		321 536 900 113		90	21.5	9.9	75	1800		im KIT enthalten 321 600 300 113			S	FRE	C	E	D	L1	V	105	
VW Touran auch für Cross-Touran 08/10-: Bitte Klappe für Stoßfängerausschnitt beim VW- Händler bestellen.	03/03-09/15			321 838 600 001		90	20.0	9.9	75	1800		321 600 300 113			S	FRE	C	E	D	L1	V	105	
		KIT		321 838 900 113		90	22.0	9.9	75	1800		im KIT enthalten 321 600 300 113			S	FRE	C	E	D	L1	V	105	
VW Touran	09/15-			321 814 600 001		60	15.5	10.8	80	2100		305 407 300 113	für Fzg. mit Vorrüstung	S	CAN	C	E	D	L	H		30	
				321 815 600 001		60	16.0	10.8	80	2100		305 408 300 107	→ für Fzg. ohne Vorrüstung	S	CAN	C	E	--	--			V	60
												305 408 300 113	für Fzg. ohne Vorrüstung	S	CAN	C	E	D	L		V	60	
													305 438 300 113	inkl. WLC 2.0 für Fzg. ohne Vorrüstung	S	CAN	C	E	D	L1		V	90
VW Touran für Fzg. ohne Vorrüstung	09/15-	KIT		321 814 900 113		60	19.5	10.8	80	2100		im KIT enthalten 305 408 300 113	für Fzg. ohne Vorrüstung	S	CAN	C	E	D	L		V	60	
		KIT		321 819 900 113		60	17.4	10.8	80	2100		im KIT enthalten 305 438 300 113	inkl. WLC 2.0 für Fzg. ohne Vorrüstung	S	CAN	C	E	D	L1		V	90	
		KIT		321 815 900 113		60	20.0	10.8	80	2100		im KIT enthalten 305 408 300 113	für Fzg. ohne Vorrüstung	S	CAN	C	E	D	L		V	60	
		KIT		321 818 900 113		60	17.9	10.8	80	2100		im KIT enthalten 305 438 300 113	inkl. WLC 2.0 für Fzg. ohne Vorrüstung	S	CAN	C	E	D	L1		V	90	
VW Transporter T4 Kasten/ Kombi auch für Syncro und Caravelle	01/96-07/03			321 391 600 001		90	20.2	13.4	105	2600		321 318 300 113	09/98-	S	C2	--	--	D1	--			45	
VW Transporter T4 Kasten/ Kombi auch für Syncro und Caravelle Halter für Kugelstange: 921405631005	01/96-07/03			321 405 600 001		90	21.0	13.4	100	2600		321 318 300 113	09/98-	S	C2	--	--	D1	--			45	

VW Transporter T4 Kasten/ Kombi auch für Syncro und Caravelle	09/98-07/03	KIT		321 391 900 113			90	22.2	13.4	105	2600		im KIT enthalten 321 318 300 113	09/98-	S	C2	--	--	D1	--			45	
	VW Transporter T5 Kasten/ Kombi inkl. Kugelplatte auch für 4-Motion nicht für Rockton Um den optimalen Sitz des Stoßfängers zu gewährleisten, empfehlen wir die Montage eines Schaumträgers VW-Nr. 7H0 807 252 A, erhältlich beim VAG- Partner. Bitte beim VW-Händler bestellen: Aufnahme für Kugelstange: 7H0 804 897 A Spannband: 7H0 867 749 Kastenwagen (ohne hintere Seitenfenster) 10/09: Um den optimalen Sitz des Stoßfängers zu gewährleisten, empfehlen wir die Montage von - 1 x Kunststoffleister 7H0 807 723 - 8 x Tülle 357 853 586 B - Clip 701 867 299				322 123 600 001			120	17.5	14.0		2800		300 028 300 113	Zusatzkabel für Ladeleitung (Bitte zusätzlich bestellen.)									
													321 025 300 113	Zusatzkabel für Dauerplus (Bitte zusätzlich bestellen.)	--	--	--	E1	D	L	V			
													321 451 300 100	-10/09 Zusatzkabel GSTab folgenden Fg-Nr.kann die Gespannstabilisierung aktiviert werden:WV2ZZZ7HZ u. ...H059728 (Bitte zusätzlich bestellen.)	S	--	--	E1	--	--	V	60		
													321 451 300 113	-10/09	S	C2	C	E	D1	L1	H		45	
													321 455 300 001	10/09- Erweiterungssatz für Kfz. ohne Sicherungsbox unter dem Fahrersitz (Bitte zusätzlich bestellen.)	S						V	60		
													321 650 300 113	07/11-05/12 für Fzg. mit Vorrüstung	S	CAN	--	E	D	L1	H		30	
													321 652 300 113	05/12-08/15 für Fzg. mit Vorrüstung	S	CAN	--	E	D	L	H		30	
													321 681 300 113	10/09-08/15 inkl. WLC 2.0 für Fzg. mit Vorrüstung	S	CAN	C	E	D	L1	V		180	

Volkswagen

Volkswagen

VW Transporter T5 Kasten/ Kombi auch für 4-Motion nicht für Rockton Um den optimalen Sitz des Stoßfängers zu gewährleisten, empfehlen wir die Montage eines Schaumträgers VW-Nr. 7H0 807 252 A, erhältlich beim VAG- Partner. Bitte beim VW-Händler bestellen: Aufnahme für Kugelstange: 7H0 804 897 A Spannband: 7H0 867 749 Kastenwagen (ohne hintere Seitenfenster) 10/09: Um den optimalen Sitz des Stoßfängers zu gewährleisten, empfehlen wir die Montage von - 1 x Kunststoffleister 7H0 807 723 - 8 x Tülle 357 853 586 B - Clip 701 867 299	04/03-10/09	KIT KIT	 	321 792 900 113			115	21.5	14.0	100	2500		im KIT enthalten 321 451 300 113	-10/09	S	C2	C	E	D1	L1	H	45
				321 717 900 113			120	21.0	14.0	100	2500		im KIT enthalten 321 451 300 113	-10/09	S	C2	C	E	D1	L1	H	45
				321 451 300 100										-10/09 Zusatzkabel GSTab folgenden Fg-Nr.kann die Gespannstabilisierung aktiviert werden:WV2ZZZ7HZ u. ...H059728 (Bitte zusätzlich bestellen.)	S	--	--	E1	--	--	V	60
321 025 300 113													Zusatzkabel für Dauerplus (Bitte zusätzlich bestellen.)	--	--	--	E1	D	L	V		



VW Transporter T5 Kasten/ Kombi auch für 4-Motion, nicht für Rockton Um den optimalen Sitz des Stoßfängers zu gewährleisten, empfehlen wir die Montage zweier Schaumträger 7H0 807 252 A, erhältlich beim VW-Händler Kastenwagen (ohne hintere Seitenfenster) 10/09-: Um den optimalen Sitz des Stoßfängers zu gewährleisten, empfehlen wir die Montage von: 1 x Kunststoffleiste 7H0 807 723 8 x Tülle 357 853 586 B 8 x Clip 701 867 299	04/03-08/15		322 122 600 001			90	18.0	14.0	100	2500		300 028 300 113	Zusatzkabel für Ladeleitung (Bitte zusätzlich bestellen.)											45
												321 025 300 113	Zusatzkabel für Dauerplus (Bitte zusätzlich bestellen.)	--	--	--	E1	D	L	V				
												321 451 300 100	-10/09 Zusatzkabel GSTab folgenden Fg-Nr.kann die Gespannstabilisierung aktiviert werden:VV2ZZZ7HZ u. ...H059728 (Bitte zusätzlich bestellen.)	S	--	--	E1	--	--	V			60	
												321 451 300 113	-10/09	S	C2	C	E	D1	L1	H			45	
												321 454 300 113	10/09-08/15 für Fzg. ohne Vorrüstung	S	CAN	C	E	D	L1	V			180	
												321 455 300 001	10/09- Erweiterungssatz für Kfz. ohne Sicherungsbox unter dem Fahrersitz (Bitte zusätzlich bestellen.)	S						V			60	
												321 650 300 113	07/11-05/12 für Fzg. mit Vorrüstung	S	CAN	--	E	D	L1	H			30	
												321 652 300 113	05/12-08/15 für Fzg. mit Vorrüstung	S	CAN	--	E	D	L	H			30	
321 681 300 113	10/09-08/15 inkl. WLC 2.0 für Fzg. mit Vorrüstung	S	CAN	C	E	D	L1	V			180													

Volkswagen

Volkswagen

VW Transporter T5 Kasten/ Kombi auch für 4-Motion nicht für Rockton Um den optimalen Sitz des Stoßfängers zu gewährleisten, empfehlen wir die Montage eines Schaumträgers VW-Nr. 7H0 807 252 A, erhältlich beim VAG-Partner. Bitte beim VW-Händler bestellen: Aufnahme für Kugelstange: 7H0 804 897 A Spannband: 7H0 867 749 Kastenwagen (ohne hintere Seitenfenster) 10/09: Um den optimalen Sitz des Stoßfängers zu gewährleisten, empfehlen wir die Montage von - 1 x Kunststoffleiste 7H0 807 723 - 8 x Tülle 357 853 586 B - Clip 701 867 299	04/03-08/15		322 124 600 001			120	18.0	14.0	100	2500	300 028 300 113	Zusatzkabel für Ladeleitung (Bitte zusätzlich bestellen.)										45
											321 025 300 113	Zusatzkabel für Dauerplus (Bitte zusätzlich bestellen.)	--	--	--	E1	D	L	V			
											321 451 300 100	-10/09 Zusatzkabel GSTab folgenden Fg-Nr.kann die Gespannstabilisierung aktiviert werden:WV2ZZZ7HZ u. ...H059728 (Bitte zusätzlich bestellen.)	S	--	--	E1	--	--	V	60		
											321 451 300 113	-10/09	S	C2	C	E	D1	L1	H	45		
											321 454 300 113	10/09-08/15 für Fzg. ohne Vorrüstung	S	CAN	C	E	D	L1	V	180		
											321 455 300 001	10/09-Erweiterungssatz für Kfz. ohne Sicherungsbox unter dem Fahrersitz (Bitte zusätzlich bestellen.)	S						V	60		
											321 650 300 113	07/11-05/12 für Fzg. mit Vorrüstung	S	CAN	--	E	D	L1	H	30		
											321 652 300 113	05/12-08/15 für Fzg. mit Vorrüstung	S	CAN	--	E	D	L	H	30		
											321 681 300 113	10/09-08/15 inkl. WLC 2.0 für Fzg. mit Vorrüstung	S	CAN	C	E	D	L1	V	180		

VW Transporter T5 Kasten/ Kombi inkl. Kugelplatte auch für 4 Motion 51 mm Vierkantaufnahme	04/03-08/15		322 131 600 001			60	20.9	13.8	160	2500																										
											300 028 300 113	Zusatzkabel für Ladeleitung (Bitte zusätzlich bestellen.)																				45				
											321 025 300 113	Zusatzkabel für Dauerplus (Bitte zusätzlich bestellen.)	--	--	--	E1	D	L	V																	
											321 451 300 100	-10/09 Zusatzkabel GS-Tab folgenden Fg-Nr.kann die Gespannstabilisierung aktiviert werden:WV2ZZZ7HZ u. ...H059728 (Bitte zusätzlich bestellen.)	S	--	--	E1	--	--	V	60																
											321 451 300 113	-10/09	S	C2	C	E	D1	L1	H	45																
											321 454 300 113	10/09-08/15 für Fzg. ohne Vorrüstung	S	CAN	C	E	D	L1	V	180																
											321 455 300 001	10/09- Erweiterungssatz für Kfz. ohne Sicherungsbox unter dem Fahrersitz (Bitte zusätzlich bestellen.)	S						V	60																
											321 650 300 113	07/11-05/12 für Fzg. mit Vorrüstung	S	CAN	--	E	D	L1	H	30																
											321 652 300 113	05/12-08/15 für Fzg. mit Vorrüstung	S	CAN	--	E	D	L	H	30																
321 681 300 113	10/09-08/15 inkl. WLC 2.0 für Fzg. mit Vorrüstung	S	CAN	C	E	D	L1	V	180																											





VW Transporter T5 Pritsche Hochladepritsche	04/03-08/15		321 973 600 001			60	25.0	13.8	105	2500	300 028 300 113	Zusatzkabel für Ladeleitung (Bitte zusätzlich bestellen.)									45									
												321 454 300 113	10/09-08/15 für Fzg. ohne Vorrüstung	S	CAN	C	E	D	L1	V			180							
												321 455 300 001	10/09- Erweiterungssatz für Kfz. ohne Sicherungsbox unter dem Fahrersitz (Bitte zusätzlich bestellen.)	S							V			60						
												321 651 300 113	07/11-05/12 für Fzg. mit Vorrüstung	S	CAN	--	E	D	--	H				15						
												321 653 300 113	05/12-08/15 für Fzg. mit Vorrüstung	S	CAN	C	E	D	L	H				30						
												321 681 300 113	10/09-08/15 inkl. WLC 2.0 für Fzg. mit Vorrüstung	S	CAN	C	E	D	L1	V				180						
VW Transporter T6 Kasten/ Kombi	06/15-		322 122 600 001			90	18.0	14.0	100	2500	300 028 300 113	Zusatzkabel für Ladeleitung (Bitte zusätzlich bestellen.)										45								
												322 124 600 001	120	18.0	14.0	100	2500	321 025 300 113	Zusatzkabel für Dauerplus (Bitte zusätzlich bestellen.)	--	--	--	E1	D	L	V				
																			321 454 300 113	06/15-09/19 für Fzg. ohne Vorrüstung	S	CAN	C	E	D	L1	V		180	
																			321 455 300 001	Erweiterungssatz für Kfz. ohne Sicherungsbox unter dem Fahrersitz (Bitte zusätzlich bestellen.)	S							V		60
																			321 652 300 113	06/15- für Fzg. mit Vorrüstung	S	CAN	--	E	D	L	H			30
																			321 681 300 113	06/15-09/19 inkl. WLC 2.0 für Fzg. mit Vorrüstung	S	CAN	C	E	D	L1	V			180
																			322 074 300 113	10/19- für Fzg. ohne Vorrüstung	S	CAN	C	E	D	L	V			120

Volkswagen

Volkswagen

VW Transporter T6 Kasten/ Kombi inkl. Kugelplatte	06/15-		322 123 600 001	120	17.5	14.0	2800	300 028 300 113	Zusatzkabel für Ladeleitung (Bitte zusätzlich bestellen.)												45
								321 025 300 113	Zusatzkabel für Dauerplus (Bitte zusätzlich bestellen.)	--	--	--	E1	D	L	V					
								321 454 300 113	06/15-09/19 für Fzg. ohne Vorrüstung	S	CAN	C	E	D	L1	V	180				
								321 455 300 001	Erweiterungssatz für Kfz. ohne Sicherungsbox unter dem Fahrersitz (Bitte zusätzlich bestellen.)	S						V	60				
								321 652 300 113	06/15- für Fzg. mit Vorrüstung	S	CAN	--	E	D	L	H	30				
								321 681 300 113	06/15-09/19 inkl. WLC 2.0 für Fzg. mit Vorrüstung	S	CAN	C	E	D	L1	V	180				
								322 074 300 113	10/19- für Fzg. ohne Vorrüstung	S	CAN	C	E	D	L	V	120				

Volkswagen



























VW Transporter T6 Kasten/ Kombi für Fzg. ohne Vorrüstung	06/15-09/19	KIT		321 650 900 113			115	22.5	14.0	100	2500		im KIT enthalten 321 454 300 113	06/15-09/19 für Fzg. ohne Vorrüstung	S	CAN	C	E	D	L1	V	180	
		KIT		321 651 900 113			120	23.5	14.0	100	2500		321 451 300 100	Zusatzkabel GST ab folgenden Fg.-Nr. kann die Gespannstabilisierung aktiviert werden: WV2ZZZ7HZ5X0139 u. ...H059728 (Bitte zusätzlich bestellen.)	S	--	--	E1	--	--	V	60	
														321 455 300 001	Erweiterungssatz für Kfz. ohne Sicherungsbox unter dem Fahrersitz (Bitte zusätzlich bestellen.)	S						V	60
														300 028 300 113	Zusatzkabel für Ladeleitung (Bitte zusätzlich bestellen.)								
													321 025 300 113	Zusatzkabel für Dauerplus(Bitte zusätzlich bestellen.)	--	--	--	E1	D	L	V		
VW Transporter T6 Kasten/ Kombi für Fzg. ohne Vorrüstung	10/19-	KIT		322 073 900 113			115	19.7	14.0	100	2500		im KIT enthalten 322 074 300 113	10/19- für Fzg. ohne Vorrüstung	S	CAN	C	E	D	L	V	120	
		KIT		322 074 900 113			120	21.7	14.0	100	2500		im KIT enthalten 322 074 300 113	10/19- für Fzg. ohne Vorrüstung	S	CAN	C	E	D	L	V	120	

















VW Transporter T6 Pritsche	06/15-		321 973 600 001	60	25.0	13.8	105	2500	300 028 300 113	Zusatzkabel für Ladeleitung (Bitte zusätzlich bestellen.)										45							
									321 025 300 113	Zusatzkabel für Dauerplus (Bitte zusätzlich bestellen.)	--	--	--	E1	D	L	V										
									321 451 300 100	Zusatzkabel GST ab folgenden Fg.-Nr. kann die Gespannstabilisierung aktiviert werden: WV2ZZZ7HZ5X0139 u. ...H059728 (Bitte zusätzlich bestellen.)	S	--	--	E1	--	--	V	60									
									321 454 300 113	06/15-09/19 für Fzg. ohne Vorrüstung	S	CAN	C	E	D	L1	V	180									
									321 455 300 001	Erweiterungssatz für Kfz. ohne Sicherungsbox unter dem Fahrersitz (Bitte zusätzlich bestellen.)	S						V	60									
									321 653 300 113	06/15-09/19 für Fzg. mit Vorrüstung	S	CAN	C	E	D	L	H	30									
									321 681 300 113	06/15-09/19 inkl. WLC 2.0 für Fzg. mit Vorrüstung	S	CAN	C	E	D	L1	V	180									
									322 074 300 113	10/19- für Fzg. ohne Vorrüstung	S	CAN	C	E	D	L	V	120									

Volvo

Volvo S40 / V50 nicht für Sport, nicht für R-Design	02/04-12/12		320 059 600 001		40	9.7	8.9	100	1600	300 210 300 113	06/07-	--	A	--	E1	D1	L1	V	90
										320 240 300 107		S	CAN	--	E2	--	--	H	60
										320 240 300 113		S	CAN	--	E2	D	L1	H	60
Volvo S40 / V50 nicht für Sport, nicht für R-Design	06/07-12/12	KIT 	320 059 900 113		40	11.7	8.9	100	1600	im KIT enthalten 320 240 300 113	06/07-	S	CAN	--	E2	D	L1	H	60
Volvo S60	06/10-01/18		320 071 600 001		90	15.0	10.2	80	1800	300 320 300 183	Zusatzkabel für 2. Nebelschlussleuchte								
				320 072 600 001		90	17.0	10.2	80	1800		320 543 300 113	-01/18	S	CAN	--	E2	D1	L1
		KIT 	320 071 900 113		90	17.0	10.2	80	1800	im KIT enthalten 320 543 300 113	-01/18	S	CAN	--	E2	D1	L1	H	45
		KIT 	320 072 900 113		90	19.0	10.2	80	1800	im KIT enthalten 320 543 300 113	-01/18	S	CAN	--	E2	D1	L1	H	45
Volvo S60 III (224)	02/19-		320 173 600 001		60	24.1	12.6	150	2000										
				320 174 600 001		60	27.0	12.6	150	2000									
Volvo S60/V60 Cross Country	07/15-08/18		320 111 600 001		90	19.0	10.5	90	1900	300 320 300 183	Zusatzkabel für 2. Nebelschlussleuchte								
				320 112 600 001		90	20.5	10.5	90	1900		320 543 300 113	S	CAN	--	E2	D1	L1	H
		KIT 	320 111 900 113		90	20.8	10.5	90	1900	im KIT enthalten 320 543 300 113		S	CAN	--	E2	D1	L1	H	45
		KIT 	320 112 900 113		90	22.3	10.5	90	1900	im KIT enthalten 320 543 300 113		S	CAN	--	E2	D1	L1	H	45

Volvo

Volvo V60 II 225	02/18-			320 173 600 001		60	24.1	12.6	150	2000		320 173 300 107			S	A	C1	E2	--	--	H	75
				320 174 600 001		60	27.0	12.6	150	2000		320 173 300 113			S	A	C1	E2	D	L1	H	75
		KIT		320 173 900 113		60	28.9	10.7	110	2100		im KIT enthalten 320 173 300 113			S	A	C1	E2	D	L1	H	75
		KIT		320 174 900 113		60	25.7	12.6	150	2000		im KIT enthalten 320 173 300 113			S	A	C1	E2	D	L1	H	75
Volvo V60 II Cross Country 227	09/18-			320 181 600 001		60	24.2	12.6	150	2000		320 173 300 107			S	A	C1	E2	--	--	H	75
				320 182 600 001		60	27.0	12.6	150	2000		320 173 300 113			S	A	C1	E2	D	L1	H	75
		KIT		320 181 900 113		60	25.7	12.6	150	2000		im KIT enthalten 320 173 300 113			S	A	C1	E2	D	L1	H	75
		KIT		320 182 900 113		60	28.6	12.6	150	2000		im KIT enthalten 320 173 300 113			S	A	C1	E2	D	L1	H	75
Volvo V70 inkl. AWD nicht für XC70	03/00-09/07			320 090 600 001		100	21.0	10.3	80	2000		300 078 300 113	03/00-09/07	--	FRE	--	--	D1	L1	V		
Volvo V70 ohne Niveauregulierung auch für AWD	09/07-04/16			320 069 600 001		90	20.0	11.0	85	2100		300 320 300 183	Zusatzkabel für 2. Nebelschlussleuchte									
				320 075 600 001		60	22.0	11.0	85	2100		320 543 300 113		S	CAN	--	E2	D1	L1	H	45	
		KIT		320 069 900 113		90	22.0	11.0	85	2100		im KIT enthalten 320 543 300 113		S	CAN	--	E2	D1	L1	H	45	
		KIT		320 075 900 113		60	24.0	11.0	85	2100		im KIT enthalten 320 543 300 113		S	CAN	--	E2	D1	L1	H	45	

Volvo XC70 ohne Niveauregulierung	09/07-05/16			320 073 600 001		90	20.0	11.0	85	2100		300 320 300 183	Zusatzkabel für 2. Nebelschlussleuchte													
				320 076 600 001		60	24.0	11.0	85	2100		320 543 300 113		S	CAN	--	E2	D1	L1	H	45					
	KIT		320 073 900 113		90	22.0	11.0	85	2100		im KIT enthalten 320 543 300 113		S	CAN	--	E2	D1	L1	H	45						
	KIT		320 076 900 113		60	24.0	11.0	85	2100		im KIT enthalten 320 543 300 113		S	CAN	--	E2	D1	L1	H	45						
Volvo XC90	01/03-06/15			320 057 600 001		120	26.2	12.2	140	2250		320 780 300 113	09/04-	S	FRE	--	E2	D	L1	H	60					
Volvo XC90	10/04-06/15	KIT		320 057 900 113		120	28.2	12.2	140	2250		im KIT enthalten 320 780 300 113	09/04-	S	FRE	--	E2	D	L1	H	60					
Volvo XC90 auch für Hybrid	06/15-			320 102 600 001		60	25.0	13.4	140	2700		320 102 300 113		S	A	--	E2	D	L1	H	75					
		KIT		320 102 900 113		60	26.0	13.4	140	2700		im KIT enthalten 320 102 300 113		S	A	--	E2	D	L1	H	75					

Anhängeböcke, Anschraubplatten und Spezial-Kupplungen

Universal LKW-Anhängeböcke

Bitte unbedingt den D-Wert der einzelnen Komponenten beachten!
Freiräume für die Montage prüfen (Maßblatt nebenstehend)!

Anhängebock

mit integriertem Unterfahrschutz
Bestell-Nr. 313404600001
und Anschraubplatte
Bestell-Nr. 329103600001

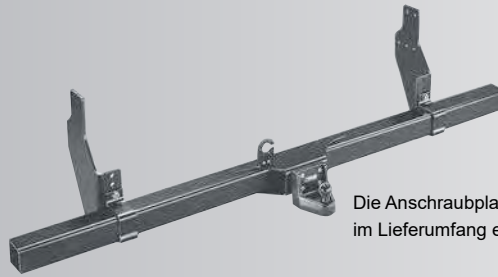

Unterfahrschutz
Prüf-Nr.: e13-6131

Die Anschraubplatte ist nicht
im Lieferumfang enthalten.

	Artikel-Nr.	kg	D-Wert kN	kg	kg	*
Anhängebock mit integriertem Unterfahrschutz für LKW Wechselsystem und/oder Maulkupplung zulässig	313404600001	69,0	25,1	150	3000 3500	17000 9400
empfohlene Anschraubplatte	329103600001	8,2	25,1	120	3000 3500	17000 9400

*Bei Verwendung als Unterfahrschutz gemäß R58/03 nur bis max.7,5t Ges.-Gew.

Anhängebock

mit integriertem Unterfahrschutz
Bestell-Nr. 342179600001
und Anschraubplatte
Bestell-Nr. 329103600001

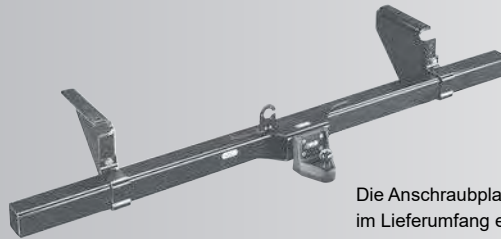

Unterfahrschutz
Prüf-Nr.: e13-6130

Die Anschraubplatte ist nicht
im Lieferumfang enthalten.

	Artikel-Nr.	kg	D-Wert kN	kg	kg	*
Anhängebock mit integriertem Unterfahrschutz für LKW Wechselsystem und/oder Maulkupplung zulässig	342179600001	76,0	23,5	150	3500	z.B. 7500
empfohlene Anschraubplatte	329103600001	8,2	25,1	120		

*Bei Verwendung als Unterfahrschutz gemäß R58/03 nur bis max.7,5t Ges.-Gew.

Universal LKW-Elektrosatz für 12V	Artikel-Nr.	fz-spez.	Blinkü-berw.	Codierung	EPH Abschaltung	Dauerplus Ladeleitung	Ladeleitung	Stromanschluss	Montagezeit
	300201300113	-	A	-	-	D1	L1	V	

Maßblatt für Anhängböcke

Alle Maßangaben in mm

Anhängböcke universell einsetzbar durch viele 2-dimensionale Verstellmöglichkeiten (Höhe und Breite)

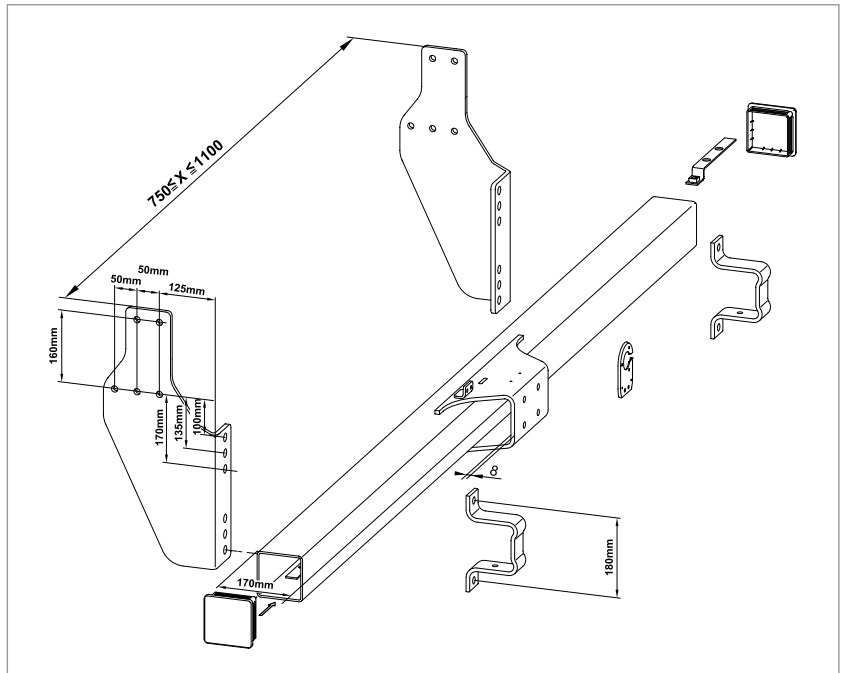



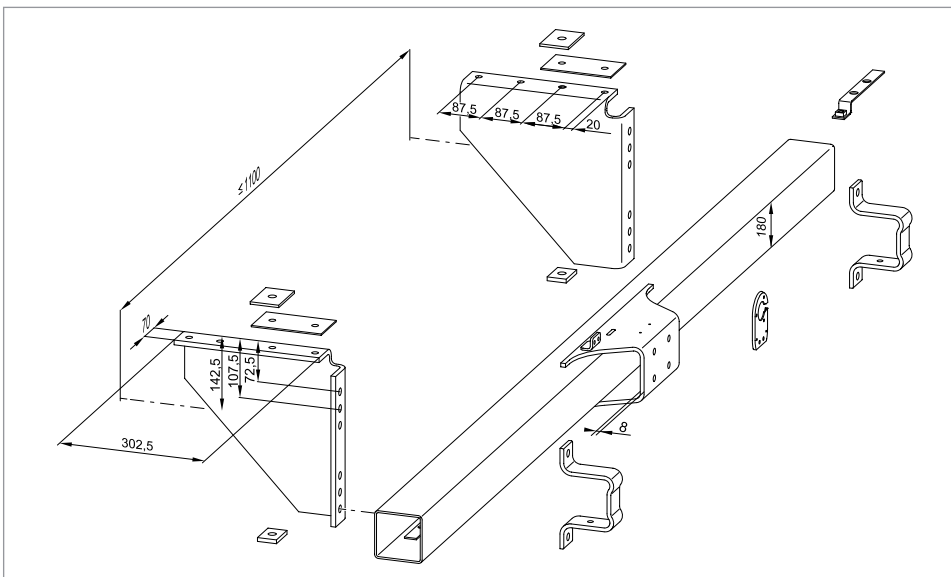

313 404



342 179

Anschaubplatten mit Kugelhals

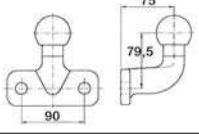
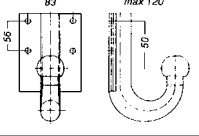
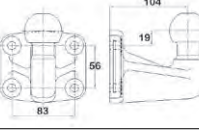
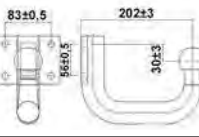
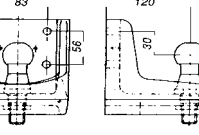
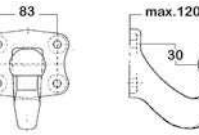
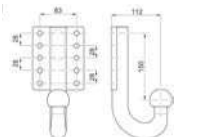
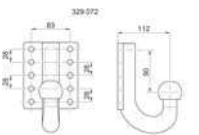
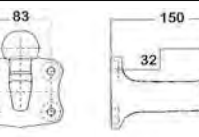
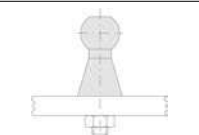
	Artikel-Nr.	 kg	D-Wert kN	 kg	 kg	kg 
	329076600001	2,4	20,55	350	2.500 oder 2.200 oder 2.000	12.924 oder 8.317 oder 5.217
	inkl. 2 Schrauben M 16 x 50, 8.8					
	329042600001 Auslaufmodell	4,4	17,2	100	2.800 oder 2.500 oder 2.000	4.700 oder 5.800 oder 14.200
	329141600001	4,0	24,8	250	3.500 oder 3.815 oder 3.385	9.115 oder 7.500 oder 10.000
	329143600001	4,5	17,5	200	4.900 oder 6.200 oder 3.600	2.800 oder 2.500 oder 3.500
	329103600001	8,5	25,1	150	3.500 oder 2.500 oder 3.000	9.400 oder 40.000 oder 17.000
	329062600001	3,6	23,5	150	2.800 oder 3.100 oder 3.500	15.000 oder 10.000 oder 7.500
	329160600001 Für Fahrzeuge ohne Bremsseilöse wird der Bremsseilhalter 329071631001 benötigt.	4,1	17,5	150	2.500 oder 2.800 oder 3.500	6.200 oder 4.900 oder 3.600
	329072600001	3,7	17,5	150	2.500 oder 2.800 oder 3.500	6.200 oder 4.900 oder 3.600
	329089600001	2,8	17,5	150	2.800 oder 2.500 oder 3.500	4.900 oder 6.200 oder 3.600
	329113600001	1,0	17,17	140	2.800 oder 2.500 oder 2.000	4.700 oder 5.800 oder 14.000

Befestigungsteile für Anschraubplatten



Querträger des Zugfahrzeugs oder Anhängewagens	Kugelplatten (die Artikel-Nr. endet immer mit ...600001)	Schraubentüten*
8 - 12 mm	329 042 329 059, 329 062, 329 071, 329 072 329 060, 329 089, 329 103	900 040 632 340 900 045 632 325 900 055 632 552
15 - 20 mm	329 042, 329 057, 329 062, 329 071, 329 072 329 059 329 060, 329 103	900 050 632 424 900 055 632 552 900 060 632 523
60 - 65 mm	329 042, 329 062, 329 071, 329 072 329 059 329 060, 329 103, 329 089	900 095 632 553 900 100 632 527 900 105 632 554
65 - 70 mm	329 042, 329 062, 329 071, 329 072 329 059 329 060, 329 103, 329 089	900 100 632 527 900 105 632 554 900 110 632 505
70 - 75 mm	329 042, 329 062, 329 071, 329 072 329 059 329 060, 329 103, 329 089	900 105 632 554 900 110 632 505 900 115 632 524
75 - 80 mm	329 042, 329 062, 329 071, 329 072 329 059 329 060, 329 103, 329 089	900 110 632 505 900 115 632 524 900 120 632 516
80 - 85 mm	329 042, 329 062, 329 071, 329 072 329 059 329 060, 329 103, 329 089	900 115 632 524 900 120 632 516 900 125 632 504
85 - 90 mm	329 042, 329 062, 329 071, 329 072 329 059 329 060, 329 103, 329 089	900 120 632 516 900 125 632 504 900 130 632 539
90 - 95 mm	329 042, 329 062, 329 071, 329 072 329 059 329 060, 329 103, 329 089	900 125 632 504 900 130 632 539 900 135 632 379

* Die Schraubentüten enthalten jeweils: 4 Schrauben M10 10.9, 4 Muttern, 8 Scheiben.
Aus der 4.-6. Stelle der Artikel-Nummer geht die Länge der Schrauben in mm hervor.

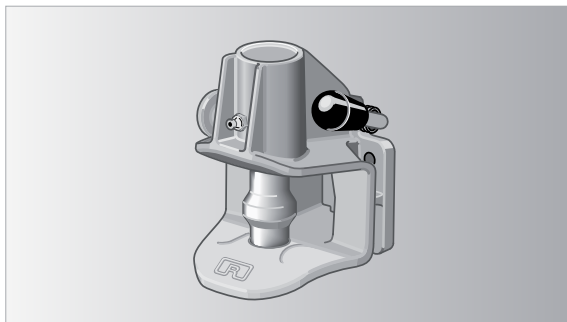
Fangmaul-Anhängerkupplung



Anhängerkupplung
Rockinger-Nr. 243A11000

Bestell-Nr.	Lochbild mm	D-Wert kN	Dc-Wert kN (je nach Kugellage)	 kg	 kg
342090600001	83 x 56	18,0	min. 18,0 max. 30,0	5,0	250

Wechselsysteme

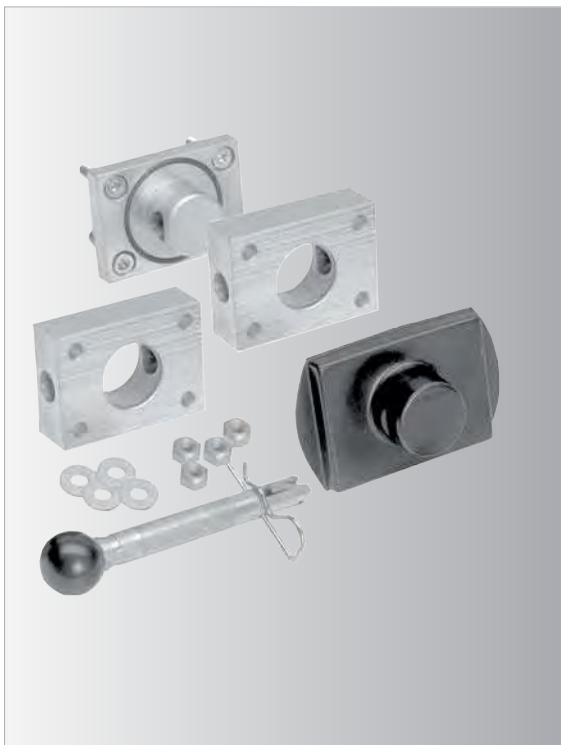

Bestell-Nr.	Lieferumfang	Lochbild mm	D/Dc-Wert kN	kg	kg
329064600001	1 Grundplatte 2 Wechselplatten 1 Abdeckkappe	83 x 56	18,5	3,5	120

Verwendung in Verbindung mit:



Anschraubplatten

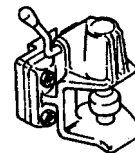

Maulkupplungen

* Schrauben/Befestigungsmaterial (abhängig von Anhängelock und Kugelplatte) siehe unten.

Ersatzteile für Wechselsystem 329064600001

Art.-Nr.	Bezeichnung
929 064 605 002	Grundplatte
900 001 508 003	O-Ring
929 064 605 101	Wechselplatte
929 064 630 101	Abdeckkappe
929 064 625 001	Bolzen

Befestigungsteile für Wechselsystem

Schraubentüten*	Kugelplatte an Wechselplatte	Flansch	Schrauben
900 050 636 186	329 042	5 - 10 mm	M 10 x 50
900 055 636 187	329 059, 329 062, 329 072, 329 089 Rockinger-Bolzenkupplung	10 - 15 mm	M 10 x 55
900 060 636 188	329 060, 329 103	15 - 20 mm	M 10 x 60

Schraubentüten*	Grundplatte am Zugfahrzeug oder Anhängerkupplung	Schrauben
900 040 636 176	8 - 12 mm	M 10 x 40
900 100 636 180	70 - 75 mm	M 10 x 100
900 110 636 182	80 - 85 mm	M 10 x 110
900 130 636 185	95 - 105 mm	M 10 x 130

* Die Schraubentüten enthalten jeweils: 4 Zylinderschrauben mit Innensechskant M10 (10.9)
4 Muttern M10
4 Scheiben 10,5

Aus der 4.-6. Stelle der Artikel-Nummer geht die Länge der Schrauben in mm hervor.

Wechselplattensysteme

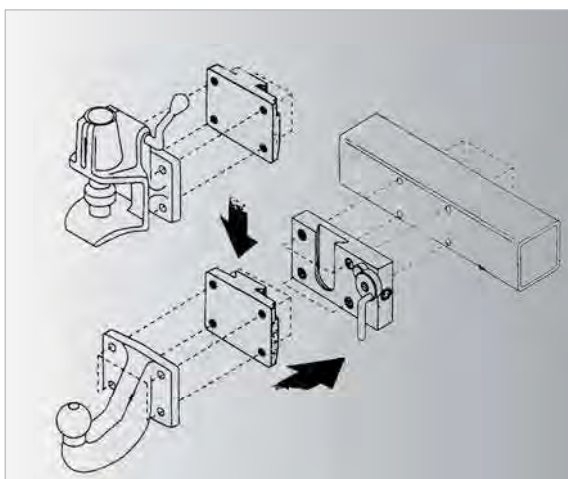

Bestell-Nr.	Lieferumfang	Lochbild mm	D/Dc-Wert kN	kg	kg
342032600001	1 Grundplatte 2 Wechselplatten	83 x 56	30	5,8	120

Verwendung in Verbindung mit:



Anschraubplatten

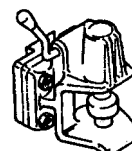

Maulkupplungen

* Schrauben/Befestigungsmaterial (abhängig von Anhängelock und Kugelplatte)

Zubehör Spezial-Kupplungen



Bestell-Nr.	900 001 005 062
zul. Ges.-Gewicht kg	3500
Stützlast kg	140
D-Wert kN	20,2
Gewicht kg	3,0

Die Kombination mit den Wechselplattensystemen 329064600001 und 329073600001 ist nicht möglich.

Spezial-Kupplungen



Bestell-Nr.	329 142 600 001
Flanschplatte	
Loch Ø mm	17
Lochabstand mm	4-Loch, 90 x 45
zul. Ges.-Gewicht kg	3500
D-Wert kN Flansch	23,4
Stützlast kg Flansch	350
Gewicht kg	3,5



Bestell-Nr.	329 091 600 001
Flanschplatte	114 x 73
Loch Ø mm	17
Lochabstand mm	2-Loch, 90
zul. Ges.-Gewicht kg	3500
Öffnung mm	50 Ø
D-Wert kN	27,5
Stützlast kg	150
Gewicht kg	3,5



Bestell-Nr.	329 094 600 001	329 090 600001 Auslauf
Flanschplatte	122 x 91	122 x 91
Loch Ø mm	10-11	10-11
Lochabstand mm	4-Loch, 90	4-Loch, 83 x 56
zul. Ges.-Gewicht kg	3500	3500
D-Wert kN	31	31
Stützlast kg	340	340
Gewicht kg	5,2	5,2



Bestell-Nr.	342 311 600 001	900001001850
Lieferumfang	1 Basisplatte 1 Anschraubplatte (2-Loch) 1 Steckdosenhalter 1 Befestigungsteile	1 Basisplatte 1 Befestigungsteile
D/Dc-Wert	17,17	17,17
Eigengewicht kg	8	2,7
Stützlast kg	140	140
Anhängelast kg	3500	2700



mit viereckiger Aufnahme und 51,5 x 51,5mm Durchmesser

Anhängekupplungen

Zubehör
Ersatzteile

Zubehör



Kugelschutzkappe

VPE 10 Stck.
VPE 100 Stck.: Art.-Nr. 917 034 630 100
VPE 800 Stck.: Art.-Nr. 917 034 630 101

Art.-Nr.: 917 034 630 010



Kugelschutzkappe blau "CAP"

VPE 10 Stck.
VPE 50 Stck.: Art.-Nr. 300 050 001 909

Art.-Nr.: 300 010 001 909



Grensrachenlehre

ohne Kalibrierschein

Ein Kalibrierschein kann separat beim Lieferanten bestellt werden. Bitte kontaktieren Sie hierzu:

Firma Messwelk

<https://www.messwelk.de/>

Ansprechpartner: Herr Jäger, Tel.: 06027-500327

Art.-Nr.: 900 001 535 051

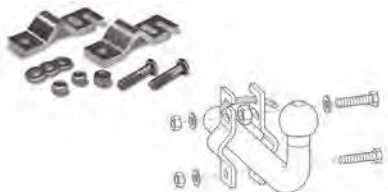

Sicherungsschelle

für das Sicherungsbremssseil des Anhängers

Art.-Nr.: 935 211 627 001



Sicherungsschelle 50 mm Ø

für das Sicherungsbremssseil des Anhängers

Art.-Nr.: 921 540 627 001



Sicherungsschelle 56 mm Ø

für das Sicherungsbremssseil des Anhängers

Art.-Nr.: 905 243 627 001



Sicherungsschelle 84 mm Ø

für das Sicherungsbremssseil des Anhängers

Art.-Nr.: 905 276 627 001

Zubehör



Präsentationsständer für Anhängekupplungen

Anhängekupplungen gehören nicht zum Lieferumfang

Art.-Nr.: 300 100 600 001

Trittstufen



Trittstufe

für Mercedes Benz Sprinter II und VW LT Crafter 03/06-
(Kasten- und Kombimodelle)
Nur in Verbindung mit den KmHs WAM-Nr.:
313267/272/273/367 600001

Art.-Nr.: 313 285 600 001



Trittstufe universal

Alle Anhängerböcke mit 4er Lochbild und Anhängerböcke mit
2er Lochbild mit einem Lochabstand von 90mm
Z.B. Citroën Jumper, Fiat Ducato, Mercedes Sprinter,
Peugeot Boxer, VW Crafter usw.

Art.-Nr.: 313 440 600 001

Verschlusskappen



Verschlusskappen

seitlich, 342035 und 332110 (LU: 2 Stück), 342076 /
313146 / 313192 / 313193 / 313404 / 342179

Art.-Nr.: 900 001 503 587

Ersatzteile abnehmbare Anhängerkupplungen



Schlüssel für Schloß AutomatikKugelstange

(VPE=2 Stk.)

* Die letzten beiden Ziffern sind die Nummern, die auf dem Schlüsselkopf stehen bzw. die Sie sich in der Bedienungsanleitung notiert haben. Erklärung und Verfahrensweise zur Schlüsselbestellung finden Sie im Internet unter www.westfalia-automotive.com/de/service-support/faq/

Art.-Nr.: 942 001 513 2xx



Master-Schlüsselsatz für abnehmbare Anhängervorrichtungen

Art.-Nr.: 942 001 513 999



Abdeckkappe

für Schloß AutomatikKugelstange (VPE=2 Stk.)
(VPE=10 Stk.: Art.-Nr. 905 112 630 101)

Art.-Nr.: 905 111 630 101



Abdeckkappe

mit Sicherung gegen Verlust für Schloß
AutomatikKugelstange
(VPE=2 Stk.)
(VPE=10 Stk.: Art.-Nr. 921 534 630 102)

Art.-Nr.: 921 534 630 101



Skai-Leder-Tasche

mit Reißverschluss
für alle abnehmbaren Anhängerkupplungen

Art.-Nr.: 900 001 504 923



Metallmutter

(incl. 4 Stahlkugeln, 1 Sprengring)

Ø der Kugelstange bis 40mm

Art.-Nr.: 914 234 622 101

Ersatzteile abnehmbare Anhängerkupplungen



Schenkelfeder

für abnehmbare Kugelstange - Mutternsystem

Art.-Nr.: 903 057 626 001

Artikel-Nr. Anhängervorrichtung	Typ	Ersatz-Kugelstange	Verschlussstopfen	Zubehörtüte	Steckdosenhalter	Aufnehmerrohr & weitere Befestigungsteile	Halter für Steckdosenhalter & weitere Befestigungsteile
303078600001	303 078 AUSF. A	903078601001	903078630121	903078650001	-	-	903078611003
303091600001	303 090	nicht mehr lieferbar	921630630121	--	--	--	--
303095600001	303 094 AUSF. B	935268601001	913183630121	903095650001	-	-	-
303113600001	303 084 AUSF. B	903085601001	903078630121	903085650001	-	903057619001	903081616102
303123600001	303 121	903078601001	903078630121	903121650001	-	-	-
303124600001	303 121	903078601001	903078630121	903121650001	-	-	-
303127600001	303 127	935268601001	903078630121	-	903127650001	-	903127619001
303130600001	303 078 AUSF. A	nicht mehr lieferbar	903078630121	903130650001	-	903078611001	-
303140600001	303 140	906230601003	903140630103	903140650002	-	-	903140619001
303144600001	303 127	935268601001	903078630121	-	903127650001	-	903144619001
303149600001	303 149	903078601001	903078630121	903149650001	-	-	-
303150600001	303 149	903078601001	903078630121	903149650001	-	-	-
303155600001	303 155	906230601003	903078630121	903140650002	-	-	903140619001
303173600001	303 149	903078601001	903078630121	903149650001	-	-	-
303176600001	303 176	903078601001	903078630121	903149650001	-	-	-
303178600001	303 176	903078601001	903078630121				
303185600001	303 174	903174600011	903140630103				
303189600001	303 189	903189601090	903078630121	-	-	-	-
303202600001	303 186	903186600003	903140630103	903202650001	921504608001	-	-
303205600001	303 205	915055601001	903078630121	903205650001	-	-	-
303207600001	303 137	903170601006	903137630101	903207650001	-	-	-
303212600001	303 212	-	-	903212650001	-	-	-
303228600001	303 134 (A)	935268601001	913183630121	903228650001	-	-	903228619001
303229600001	303 134 (A)	935268601001	913183630121	903228650001	-	-	903229691001
303230600001	303 140A	903230601005	903078630121	903230650002	921504608001	-	903140619001
303231600001	303 174 (A)	903231601005	903078630121	903230650002	-	-	903174619001
303232600001	303 155A	903230601005	903078630121	903230650002	921504608001	-	903140619001
303235600001	303 186	903186601003	903140630103				
303237600001	303 186	903186601003	921630630121				
303240600001	303 240	914251601090	913183630121	903240650001	921504608001	-	-
303241600001	303 241	-	-	903241650001	-	-	-
303253600001	303 186	903186601003	921630630121				
303266600001	303 264	914251601090	913183630121	903266650001	921504608001	-	-
303267600001	303 265	-	-	903267650001	-	-	-
303273600001	303 265	903273601009	921630630121	903273650001	921504608001	-	-
303290600001	303 290	903290601009	903137630101	903290650001	-	-	-
303294600001	303 294	903292601019	921630630121	903294650001	921504608001	-	-
303309600001	303 309	-	-	903273650001	-	-	-
303298600001	303 205	915055601001	903078630121				
303299600001	303 140 (A)	903230601005	921630630121				
303300600001	303 155 (A)	903230601005	921630630121				
303301600001	303 186	903186601003	921630630121	303202650001	921504608001	-	-
303302600001	303 186	903186601003	921630630121	303202650001	921504608001	-	-
303303600001	303 240	914251601090	913183630121	303240650001	921504608001	-	-
303304600001	303 189	903189601090	903078630121	-	-	-	-
303313600001	303 313	-	-	903313650001	-	-	-
303314600001	303 314	907336601090	921630630121	903313650001	921504608001	-	-
303317600001	303 317	903315601006	913183630121	903317650001	907292608001	-	-
303323600001	303 323	915055601001	903078630121	903205650001	-	-	-
303328600001	303 294	903292601019	921630630121				
303330600001	303 240	914251601090	913183630121	903240650001	921504608001	-	-
303332600001	303 240	914251601090	913183630121				
303333600001	303 304	903189601090	921630630121				
303336600001	303 336	903292601019	921630630121	903336650001	921504608001	-	-
303337600001	303 337	-	-	903337650001	-	-	-
303338600001	303 342	916128601090	903078630121	903337650001	921504608002	-	-
303339600001	303 339	-	-	903339650001	-	-	-
303340600001	303 340	921546601090	921630630121	903339650001	921504608002	-	-
303351600001	303 351	-	-	903351650001	-	-	-
303352600001	303 352	907305601090	903078630121	903351650001	932541608002	-	303352613001
303355600001	303 355	-	-	903372650001	-	-	-
303366600001	303 366	907305601090	921630630121	903351650001	932541608002	-	303352613001
303368600001	303 273	903273601009	921630630121	903273650001	921504608001	-	-
303370600001	303 370	903292601019	921630630121	903336650001	921504608001	-	-
303372600001	303 372	903315601006	903078630121	903372650001	921504608001	-	-
303393600001	303 313	-	-	903393650001	-	-	-
303394600001	303 314	907336601090	921630630121	903393650001	921504608001	-	-
303398600001	303 398	916128601090	913183630121	903397650001	921504608002	-	-
303404600001	303 340	905405601001	921630630121	903339650001	921504608001	-	-
303412600001	BM46AU	913082601090	913183630121	903413650001	921504608001	933096621001	933096631001
303431600001	BM38U	917034601090	921630630121		921504608001	933096621001	933096631001
303433600001	BM44U	916128601090	913183630121	-	921504608001	933096621001	933096631001
303441600001	BM37U	917034601090	921630630121	-	-	-	-
303476600001	BM48U	914294601090	913183630121		921504608001	933096621001	933096631001
303478600001	BM47U	913082601090	913183630121		921504608001	933096621001	933096631001
303483600001	BM49U	907200601005	921630630121	903495650001	921504608001	933096621001	933096631001
303485600001	BM50U	920057601090	913183630121		921504608001	933096621001	933096631001
303487600001	BM51U	913082601090	913183630121		921504608001	933096621001	933096631001
303496600001	BM47AU	913082601090	913183630121	903495650001	921504608001	933096621001	933096631001
303498600001	BM53U	916128601090	913183630121	903498650001	921504608001	933096621001	933096631001

Artikel-Nr. Anhängervorrichtung	Typ	Ersatz-Kugelstange	Verschlussstopfen	Zubehörtüte	Steckdosenhalter	Aufnehmerrohr & weitere Befestigungsteile	Halter für Steckdosenhalter & weitere Befestigungsteile
303500600001	BM51AU	913082601090	913183630121	903499650001	921504608001	933096621001	933096631001
303513600001	BM1247	932098601090	913183630121		907292608001	-	-
303514600001	---	914251601090	913183630121		907292608001	-	-
303517600001	BM878U	913082601090	913183630121	903516650001	907292608001	933096621001	933096631001
304056600001	304 056	nicht mehr lieferbar	921630630121	904056650001		904056617001	-
304057600001	304 057	904057601001	921630630121	904057650001	-	-	-
304059600001	304 048	nicht mehr lieferbar	903011630108	904047650001	-	904047619001	-
304060600001	304 060 (A)	nicht mehr lieferbar	903011630108	904060650001	-	904060606001	-
304068600001	304 068	906187601090	913183630121	904068650001	-	-	-
304072600001	304 072	914266601001	913183630121	904072650001	921504608001	-	-
304073600001	304 073	921505601005	913183630121	904073650001	921504608001	-	-
304079600001	304 078	916114601001	913183630121	904079650001	-	-	-
304092600001	SI 080	914294601090	921630630121	-	-	-	-
304100600001	304 100	914294601090	913183630121	904099650001	921504608001	-	-
304128600001	SI 107	904120601001	-	-	-	-	-
304131600001	SI 088	914294601090	921630630121	-	-	-	-
304135600001	SI 097	914251601090	913183630121	-	-	-	-
304137600001	SI 100	904119601001	-	-	-	-	-
304139600001	SI 072	921556601005	921630630121	-	-	-	-
304144600001	SI 150	915144601090	921630630121	-	-	-	-
304145600001	01.4606	916165601090	913183630121	-	-	933051621090	-
304148600001	SI 150	915144601090	921630630121	-	-	-	-
304149600001	SI 206	915144601090	921630630121	-	-	-	-
304152600001	SI 220	915144601090	921630630121	-	-	-	-
304160600001	SI 222	921556601005	921630630121	-	-	-	-
304190600001	TY184	329076600001	-	904190650001	-	-	-
304209600001	SI 255	904189601001	933034630101	-	-	-	-
304212600001	SI 255	904189601001	933034630101	-	-	-	-
304213600001	C642U	914251601090	913183630121	904213650001	921504608001	933096621001	933096631001
304216600001	SI 260	914294601090	921630630121	-	921504608001	-	-
305115600001	305 073	905071601003	921630630121	-	-	-	-
305119600001	305 073 AUSF. A	905071601003	921630630121	905119650001	-	-	-
305131600001	305 117	905117601001	905051630106	905117650001	-	905117605003	905117616001
305132600001	305 117	905117601001	921630630121	905117650001	-	905117605003	905117616001
305154600001	305 073 AUSF. H	905071601003	921630630121	905119650001	-	-	-
305156600001	305 112 AUSF. A	905112601001	905063630103	905122650001	-	905112605001	905156619001
305161600001	305 112 AUSF. A	nicht mehr lieferbar	905063630103	905122650001	-	905112605001	905156619001
305162600001	305 112 AUSF. A	905130601001	921630630121	905122650001	-	905112605001	905156619001
305195600001	305 170	nicht mehr lieferbar	905063630103	905191650001	-	-	-
305197600001	305 174	905174601001	905063630103	905191650001	-	-	-
305206600001	305 206	905208601001	905146630101	905205650001	-	-	-
305211600001	305 170	905235601001	921630630121	905170650001	-	-	-
305212600001	305 170	nicht mehr lieferbar	921630630121	905170650001	-	-	-
305213600001	305 174	905235601001	921630630121	905170650001	-	-	-
305214600001	305 174	nicht mehr lieferbar	921630630121	905170650001	-	-	-
305220600001	305 168	905208601001	905146630101	905168650001	-	-	-
305223600001	305 223	917016601090	903078630121	905222650001	-	-	-
305224600001	305 224	nicht mehr lieferbar	914234630101	905222650001	-	-	-
305225600001	305 219	905219601001	903140630103	905219650001	-	-	-
305243600001	305 170	905269601005	905063630103	905243650001	-	-	-
305244600001	305 170	905174601001	905063630103	905243650001	-	-	-
305245600001	305 174	905269601005	905063630103	905243650001	-	-	-
305246600001	305 174	905174601001	905063630103	905243650001	-	-	-
305268600001	305 269	905235601001	921630630121	905269650001	921504608001	-	-
305269600001	305 269	905269601005	905063630103	905269650001	921504608001	-	-
305275600001	305 221	nicht mehr lieferbar	921630630121	-	-	-	-
305276600001	305 221	905221601001	905219630103	905221650001	-	-	-
305277600001	305 258	917016601090	903078630121	905277650001	-	-	-
305290600001	305 269	nicht mehr lieferbar	921630630121	905291650001	921504608001	-	-
305291600001	305 269	905174601001	905063630103	905291650001	921504608001	-	-
305300600001	305 300	916128601090	913183630121	905300650001	905300650002	-	-
305302600001	305 302	905208601001	905146630101	905302650001	921504608001	-	-
305303600001	305 269	905235601001	921630630121	905291650001	921504608001	-	-
305304600001	305 269	905174601001	921630630121	-	-	-	-
305305600006	305 305	905305601001	921630630121	905365650001	905305608001	-	905323608001
305309600001	305 309	923062601001	903137630101	905309650001	921504608001	-	-
305312600001	305 297	nicht mehr lieferbar	921630630121	-	-	-	-
305314600001	305 297	921605601015	903137630101	905314650001	-	-	-
305323600001	305 305	905305601001	921630630121	905365650001	905305608001	-	905323608001
305330600001	305 170	905269601005	921630630121	905243650001	-	-	-
305331600001	305 170	905269601005	921630630121	905243650001	-	-	-
305332600001	305 302	905208601001	921630630121	905302650001	921504608001	-	-
305350600001	18.0204	920057601090	921630630121	-	-	-	-
305365600001	305 305	905365601001	921630630121	905365650001	905305608001	-	905323608001
305375600001	305 206	905208601001	921630630121	905205650001	-	-	-
305376600001	305 305	905365601001	921630630121	905323650001	905305608001	905323608001	-
305377600001	305 300	916128601090	921630630121	905300650001	905300650002	-	-
305380600001	305 296	905269601005	921630630121	-	-	-	-
305382600001	305 269	905269601005	921630630121	905291650001	921504608001	-	-
305384600001	305 384	907336601090	921630630121	905384650001	921504608001	-	-

Artikel-Nr. Anhängervorrichtung	Typ	Ersatz-Kugelstange	Verschlussstopfen	Zubehörtüte	Steckdosenhalter	Aufnehmerohr & weitere Befestigungsteile	Halter für Steckdosenhalter & weitere Befestigungsteile
305398600001	305 269	905398601005	903137630101	905269650001	921504608001	-	-
305400600001	305 400	907305601090	913183630121	905400650001	921504608001	-	-
305403600001	321 848	921546601090	921630630121	921738650001	921541608002	-	-
305405600001	321 848	921546601090	921630630121	921738650001	921541608002	-	-
305407600001	305 407	921405601090	913183630121	905428650001	921504608001	-	-
305412600001	18.4246	920057601090	921630630121	-	932218608001	933051621009	-
305415600001	305 413	921605601015	903137630101	905314650001	-	-	-
305423600001	305 423	903189601090	913183630121	905421650001	921504608001	-	-
305425600001	305 305	905365601001	921630630121	905365650001	905368608001	-	905368608010
305429600001	305 429	907305601090	913183630121	905428650001	921504608001	-	-
305437600001	305 437	906271601001	903137630101	905314650001	921504608001	-	-
305442600001	18.4246	920057601090	921630630121	-	932218608001	933051621009	-
305445600001	305 305	905365601001	921630630121	905365650001	905305608001	-	905368608010
305447600001	305 447	903315601006	913183630121	905447650001	921504608001	933051621090	-
305465600001	AD61U	913082601090	913183630121	-	921504608001	933096621001	933096631001
305515600001	AD48BU	914251601090	913183630121	-	921504608001	-	-
305555600001	AD62U	913082601090	913183630121	905605650001	921504608001	933096621001	933096631001
305558600001	AD64AU	306245660001	913183630121	-	921504608001	933096621001	933096631001
305565600001	AD63U	913082601090	913183630121	905564650001	921504608001	933096621001	933096631001
305571600001	AD65U	914251601090	913183630121	-	921504608001	933096621001	933096631001
305580600001	AD68U	913082601090	913183630121	-	921504608001	933096621001	933096631001
305600600001	---	903273601090	921628630121	-	907292608001	-	-
305601600001	AD64BU	913082601090	913183630121	305601650001	921504608001	933096621001	933096631001
305603600001	AD64BU	916128601090	913183630121	305601650001	921504608001	933096621001	933096631001
305606600001	AD62AU	913082601090	913183630121	905605650001	921504608001	933096621001	933096631001
306128600001	306 128	906128601001	903011630108	906128650001	-	-	-
306160600001	306 160	nicht mehr lieferbar	914234630101	906160650001	-	906160616101	-
306166600001	306 166	nicht mehr lieferbar	903011630108	906160650001	-	-	-
306168600001	306 168	nicht mehr lieferbar	914234630101	906164650001	-	-	-
306175600001	306 175	nicht mehr lieferbar	921630630121	906176650001	-	-	-
306176600001	306 175	nicht mehr lieferbar	903011630108	906176650001	-	-	-
306178600001	306 160	nicht mehr lieferbar	921630630121	-	-	-	-
306182600001	306 168	nicht mehr lieferbar	921630630121	-	-	-	-
306187600001	306 187	906187601090	903078630121	906187650001	-	-	-
306192600001	306 161	nicht mehr lieferbar	921630630121	-	-	-	-
306195600001	306 161	nicht mehr lieferbar	903011630108	906195650001	-	906195616101	-
306197600001	306 197	nicht mehr lieferbar	903011630108	906197650001	-	-	-
306203600001	306 203	906203601002	903011630108	906203650001	-	906203616001	-
306205600001	306 168	nicht mehr lieferbar	921630630121	-	-	-	-
306211600001	306 211	nicht mehr lieferbar	903011630108	906211650001	-	-	-
306215600001	306 215	916165601090	903078630121	906222650001	-	906215619101	-
306217600001	306 217	906174601101	914234630101	906217650001	-	906217631001	-
306218600001	306 218	906230601003	903140630103	906230650001	-	-	-
306220600001	306 189 (A)	906172601001	914234630101	906189650001	-	906189616101	-
306222600001	306 215	916165601090	903078630121	906222650001	-	906215619101	-
306225600001	306 201	nicht mehr lieferbar	921630630121	-	-	-	-
306226600001	306 201	nicht mehr lieferbar	903011630108	906206650001	-	906201616001	-
306230600001	306 218	906230601003	903140630103	906230650001	-	-	-
306231600001	306 224	906224601090	903078630121	906231650001	-	-	-
306232600001	306 232	904060601002	903011630108	906228650001	-	-	-
306235600001	306 235	nicht mehr lieferbar	903011630108	906234650001	-	-	-
306238600001	306 238	917016601090	913183630121	906241650001	-	-	-
306240600001	306 240	nicht mehr lieferbar	913183630121	906246650001	-	-	-
306241600001	306 238	917016601090	913183630121	906241650001	-	-	-
306246600001	306 239	917016601090	913183630121	906246650001	-	-	-
306247600001	306 240	916165601090	913183630121	906246650001	-	-	-
306249600001	306 237	915055601001	913183630121	906249650001	-	-	-
306250600001	306 245	906245601005	913183630121	906250650001	-	-	-
306254600001	306 251	915055601001	913183630121	906254650001	-	-	-
306262600001	306 240	914294601090	913183630121	906246650001	-	-	-
306264600001	306 264	nicht mehr lieferbar	903011630108	906228650001	-	-	-
306265600001	306 263	914294601090	903078630121	914257650001	921504608001	-	-
306266600001	306 252	921657601050	903078630121	906266650001	921504608001	-	-
306269600001	306 269	906224601090	913183630121	906268650001	-	-	-
306271600001	306 271	906271601001	903137630101	906270650001	-	906270609001	-
306275600001	306 275	915144601090	903078630121	906274650001	921504608001	-	-
306277600001	306 277	915144601090	913183630121	906276650001	921504608001	-	-
306279600001	306 215	916165601090	913183630121	906222650001	921504608001	906278619101	-
306286600001	306 286	915144601090	903078630121	906286650001	921504608001	-	-
306291600001	306 291	906224601090	913183630121	906290650001	-	-	-
306311600001	306 310	916211601001	916211630121	906311650001	921504608001	-	-
306319600001	306 319	nicht mehr lieferbar	933034630101	906211650001	-	-	-
306321600001	306 320	917044601005	913183630121	906321650001	921504608001	-	-
306323600001	306 322	914294601090	913183630121	906323650001	921504608001	-	-
306333600001	306 333	932262601007	933034630101	906333650001	-	-	-
306350600001	306 337	906350601007	933034630101	906349650001	-	-	-
306353600001	306 353	932099601001	913183630121	906353650001	921504608001	-	-
306356600001	306 356	905305601001	921630630121	906355650001	-	-	-
306363600001	306 337	906350601007	921630630121	906349650001	-	-	-
306364600001	306 333	932262601007	921630630121	906333650001	-	-	-

Artikel-Nr. Anhängervorrichtung	Typ	Ersatz-Kugelstange	Verschlussstopfen	Zubehörtüte	Steckdosenhalter	Aufnehmerohr & weitere Befestigungsteile	Halter für Steckdosenhalter & weitere Befestigungsteile
306367600001	?	921657601050	921630630121		932123608001	906231650001	9064605101 wechsellpla
306369600001	306 361	916128601090	913183630121	906368650001	921504608001	-	-
306372600001	306 371	915144601090	903078630121	906372650001	921504608001	-	-
306374600001	306 374	914251601090	913183630121	906374650001	921504608001	-	-
306381600001	306 379	916220601007	933034630101	906381650001	-	-	-
306384600001	306 383	915144601090	913183630121	906384650001	921504608001	-	-
306387600001	306 471	906423601001	921630630121	906387650001	917102608001	-	-
306389600001	306 397	905305601001	921630630121	906388650001	921504608001	-	-
306391600001	02.4267	917034601005	921630630121	-	-	933051621090	-
306393600001	306 392	913082601090	921630630121	906393650001	-	-	-
306394600001	306 383	915144601090	913183630121	906384650001	921504608001	-	-
306400600001	306 398	914357601090	921630630121	906400650001	-	-	-
306405600001	306 470	914354601009	921630630121	906407650001	921504608001	-	-
306407600001	306 469	906423601001	921630630121	906407650001	921504608001	-	-
306427600001	306 485	906423601001	921630630121	-	-	-	-
306476600001	306 467	913082601090	921630630121	906476650001	921504608001	-	-
306491600001	306 446	906271601001	903137630101	906490650001	-	-	906490650001
306504600001	FT74AU	306245660001	913183630121	-	921504608001	933096621001	933096631001
306506600001	FT74AU	914251601090	913183630121	-	921504608001	933096621001	933096631001
306519600001	AL10U	932098601090	913183630121	-	921504608001	933096621001	933096631001
306535600001	CH26U	920057601090	913183630121	-	921504608001	933096621001	933096631001
307210600001	307 213	907213601090	903078630121	907210650001	-	-	-
307212600001	307 212	907212601005	921630630121	907200650001	-	-	-
307233600001	307 233	nicht mehr lieferbar	914234630101	907233650001	-	-	-
307235600001	307 235	906187601090	903078630121	907235650001	-	-	-
307237600001	307 237	915055601001	903078630121	907237650001	-	-	-
307239600001	307 239	917016601090	903078630121	907239650001	-	-	-
307242600001	307 242	907245601090	903078630121	907242650001	921504608001	907241606001	-
307245600001	307 245	907245601090	903078630121	907245650001	921504608001	-	-
307247600001	307 245	907247601001	903078630121	907245650001	921504608001	-	-
307261600001	307 261	nicht mehr lieferbar	921630630121	907269650001	-	-	-
307265600001	307 265	916128601090	913183630121	943038650001	-	-	-
307268600001	307 261	nicht mehr lieferbar	921630630121	907269650001	-	-	-
307269600001	307 261	nicht mehr lieferbar	903078630121	907269650001	-	-	-
307274600001	307 237	nicht mehr lieferbar	921630630121	907237650001	-	-	-
307280600001	307 261	nicht mehr lieferbar	921630630121	907269650001	-	-	-
307286600001	307 290	907286601007	933034630101	907286650001	-	-	-
307290600001	307 290	907286601007	933034630101	907286650001	-	-	-
307291600001	307 291	nicht mehr lieferbar	933020630101	907291650001	-	-	-
307305600001	307 293	907305601090	913183630121	907305650001	921504608001	-	-
307308600001	307 296	921405601090	913183630121	907305650001	921504608001	-	-
307329600001	307 311	907329601090	921630630121	907329650001	921504608001	-	-
307330600001	307 312	921657601050	913183630121	907330650001	921504608001	-	-
307332600001	307 314	907329601090	921630630121	907329650001	921504608001	-	-
307333600001	307 315	915144601090	913183630121	907333650001	921504608001	-	-
307335600001	307 317	nicht mehr lieferbar	921630630121	907329650001	921504608001	-	-
307336600001	307 318	907336601090	921630630121	907329650001	921504608001	-	-
307338600001	307 338	916128601090	913183630121	907338650002	-	-	-
307340600001	307 340	932223601090	913183630121	907339650001	921504608001	-	-
307343600001	307 343	916128601090	913183630121	907342650001	921504608001	-	-
307355600001	307 355	916165601090	913183630121	907355650001	921504608001	-	-
307356600001	307 356	907296601090	913183630121	907355650001	921504608001	-	-
307385600001	307 385	907296601090	942097630101	907382650001	-	-	-
307407600001	307 265	915055601001	903078630121	943038650001	921504608001	-	-
307408600001	307 338 N	916128601090	921630630121	907338650002	-	-	-
307430600001	08.5151	nicht mehr lieferbar	900001005405	-	-	-	-
307432600001	307 293	907305601090	921630630121	907305650001	-	-	-
307433600001	307 317	nicht mehr lieferbar	921630630121	907329650001	921504608001	-	-
307434600001	307 312	921657601050	921630630121	907330650001	921504608001	-	-
307436600001	307 265	915055601001	903078630121	943038650001	921504608001	-	-
307441600001	307 441	916128601090	913183630121	907402650001	932218608002	-	-
307449600001	F165AU	907200601005	921630630121	-	921504608001	933096621001	933096621001
307455600001	307 317	907335601001	921630630121	907329650001	921504608001	-	-
307458600001	307 458	913082601090	921630630121	907456650001	932218608002	-	-
307461600001	307 461	914357601090	921630630121	907402650001	932218608002	-	-
307463600001	307 463	914294601090	913183630121	907402650001	932218608002	-	-
307463600999	307 463	914294601090	921630630121	907402650001	932218608002	-	-
307464600001	08.4237	932276601090	921630630121	-	932218608001	933054621090	-
307474600001	08.4300	907213601090	913183630121	-	932218608001	933051621090	-
307476600001	307 476	914294601090	913183630121	-	932218608001	933051621090	-
307495600001	307 495	915226601090	921630630121	-	932218608001	933054621090	-
307497600001	307 480	907329601090	921630630121	907497650001	907480608002	-	-
307498600001	307 481	907498601001	921630630121	907497650001	907480608002	-	-
307501600001	307 501	916128601090	913183630121	907500650001	921504608001	-	-
307507600001	307 507	916128601090	913183630121	907402650001	932218608002	-	-
307522600001	307 522	913082601090	921630630121	-	-	-	-
307565600001	08.4237	932276601090	921630630121	-	932218608001	933054621090	-
307567600001	08.4300	907213601090	913183630121	-	932218608001	933051621090	-
307607600001	F180AU	917034601090	921630630121	-	921504608008	933096621001	933096631001
307637600001	F183U	306245660001	913183630121	907636650001	921504608001	933096621001	933096631001

Artikel-Nr. Anhängervorrichtung	Typ	Ersatz-Kugelstange	Verschlussstopfen	Zubehörteile	Steckdosenhalter	Aufnehmerrohr & weitere Befestigungsteile	Halter für Steckdosenhalter & weitere Befestigungsteile
307639600001	F184U	917034601090	913183630121	907638650001	921504608001	933096621001	933096631001
307641600001	F185U	915144601090	913183630121		921504608001	933096621001	933096631001
307644600001	F186U	932098601090	913183630121		921504608001	933096621001	933096631001
307653600001	F182U	914251601090	913183630121	907652650001	921504608001	933096621001	933096631001
307659600001	F181AU	306245660001	913183630121	907658650001	921504608001	933096621001	933096631001
307673600001	307673600001	914357601090	921630630121		907292608001	-	-
313062600001	313 061 AUSF. B	913062601001	903011630108	913061650001	-	913061617001	-
313082600001	313 082	913082601090	921630630121	913082650001	-	913082605002	913082650003
313082600006	313 082	913082601090	921630630121	913082650001	-	913082605002	913082650003
313090600001	313 090	nicht mehr lieferbar	903011630108	913090650001	-	-	-
313117600001	313 117	906203601002	903011630108	913066650001	-	913066611001	-
313120600001	313 115	nicht mehr lieferbar	903078630121	913120650001	-	913121611001	-
313129600001	313 129	913129601001	913183630121	913129650001	-	-	-
313131600001	313 131	nicht mehr lieferbar	921630630121	-	-	-	-
313160600001	313 097	913097601009	903078630121	913097650001	-	913097650002	-
313167600001	313 167	916165601090	903078630121	913167650001	-	-	-
	313 172	913199601001	903078630121				
313174600001	313 164	917016601090	903078630121	913174650001	-	-	-
313176600001	313 165	913165601001	903078630121	913176650001	-	-	-
313179600001	313 179	913179601090	903078630121	913179650001	-	-	-
313179600006	313 179	913179601090	903078630121	913179650001	-	-	-
313183600001	313 129	913129601001	913183630121	913129650001	-	-	-
313189600001	313 189	913189601001	913183630121	913189650001	-	-	-
313192600001	313 192	913192601005	903137630101	913341650001	-	-	-
313195600001	313 195	916165601090	903078630121	913200650001	921504608001	-	913195650008
313200600001	313 200	921505601005	903078630121	913200650001	921504608001	-	-
313204600001	313 204	935268601001	913183630121	913195650001	921504608001	913195611001	913195650008
313211600001	313 211	916165601090	903078630121	913211650001	921504608001	913208611001	913195650008
313215600001	313 215	913192601005	921630630121	913341650001	-	-	-
313219600001	313 219	nicht mehr lieferbar	921630630121	913129650001	-	-	-
313222600001	313 222	932099601001	903078630121	913222650001	921504608001	-	913222650009
313231600001	313 231	915055601001	903078630121	913195650001	921504608001	913231611001	913195650008
313234600001	313 196	nicht mehr lieferbar	913183630121	913234650001	-	-	-
313239600001	313 232	913165601001	903078630121	913176650001	-	-	-
313241600001	313 115	916165601090	903078630121	913120650001	-	913121611001	-
313252600001	313 252	913252601090	921630630121	913211650001	921504608001	-	913195650008
313252600006	313 252	913252601090	921630630121	913211650001	921504608001	-	913195650008
313276600001	313 211	907296601001	903078630121	913211650001	921504608001	913208611001	913195650008
313286600001	313 097	913097601009	921630630121	913097650001	-	913097650002	-
313287600001	313 195	916165601090	921630630121	913195650001	-	913195650008	-
313288600001	313 204	935268601001	913183630121	913195650001	-	913195650008	913195611001
313289600001	313 232	913165601001	921630630121	913176650001	-	-	-
313290600001	313 167	916165601090	921630630121	913167650001	-	-	-
313314600001	313 231	915055601001	903078630121	913195650001	921504608001	913195650008	913231611001
313315600001	313 211	916165601090	921630630121	913211650001	921504608001	913195650008	913208511001
313340600001	313 192	913192601005	903137630101	913341650001	-	-	-
313345600001	313 215	913192601005	921630630121	913341650001	-	-	-
313361600001	09.4212	907329601090	921630630121	-	932218608001	933054621090	-
313369600001	313 252	913252601090	921630630121	913211650001	921504608001	913195650008	-
313373600001	09.4226	913082601090	921630630121	-	932218608001	933051621090	-
313375600001	313 211	916165601090	921630630121	913211650001	921504608001	913195650008	913208511001
313382600001	313 380	913165601001	903078630121	913176650001	-	-	-
313398600001	313 398	915055601001	913183630121	913396650001	921504608001	933051621090	-
313400600001	313 400	914294601090	913183630121	913396650001	921504608001	933051621090	-
313403600001	313 403	921405601090	913183630121	913402650001	921504608001	933051621090	-
313406600001	313 406	913406601005	903137630101	913405650001	-	-	913406609103
313421600001	313 215	913192601005	903137630101	913341650001	-	-	913406609103
313432600001	313 432	907305601090	913183630121	913431650001	921504608001	933051621090	-
313434600001	313 252	913252601090	921630630121	913211650001	921504608001	-	913195650008
313436600001	313 424	913436601001	921630630121	913435650001	-	-	-
313438600001	313 438	921505601005	903078630121	913438650001	921504608001	-	931195650008
313439600001	313 439	921405601090	903078630121	913438650001	921504608001	-	931195650008
313454600001	313222	932099601001	921630630121	913222650001	921504608001	-	-
313460600001	313460	916165601090	921630630121	913211650001	921504608001	913195650008	-
313461600001	313461	907296601001	921630630121	913211650001	921504608001	913195650008	-
313503600001	313 400	907245601090	913183630121	913396650001	921504608001	933051621090	-
313507600001	313 507	916128601090	913183630121	-	921504608001	933051621090	-
313515600001	313 515	913406601005	903137630101	913405650001	-	-	-
313524600001	MR67U	913082601090	913183630121	913523650001	921504608001	933096621001	933096631001
313556600001	MR61U	914294601090	913183630121	-	-	-	-
313562600001	MR66U	914294601090	913183630121	913561650001	921504608001	933096621001	933096631001
313640600001	MR70U	913082601090	913183630121	913639650001	921504608001	933096621001	933096631001
313662600001	MR71U	932098601090	913183630121	913661650001	921504608001	933096621001	933096631001
313710600001	MR896U	916128601090	913183630121	913710650001	921504608001	933096621001	933096631001
314234600001	314 234	nicht mehr lieferbar	914234630101	914205650001	-	914205605001	-
314235600001	314 235	nicht mehr lieferbar	914234630101	914235650001	-	914235605001	-
314244600001	314 244	nicht mehr lieferbar	914234630101	914244650001	-	914244605001	-
314251600001	314 251	914251601090	913183630121	914251650001	-	914248605001	-
314254600001	314 254	nicht mehr lieferbar	914234630101	914254650001	-	914224605001	-
314257600001	314 257	914257601090	903078630121	914257650001	-	914280605001	-

Artikel-Nr. Anhängervorrichtung	Typ	Ersatz-Kugelstange	Verschlussstopfen	Zubehörtüte	Steckdosenhalter	Aufnehmerohr & weitere Befestigungsteile	Halter für Steckdosenhalter & weitere Befestigungsteile
314266600001	314 266	914266601001	903078630121	914266650001	-	-	-
314267600001	314 267	916128601090	903078630121	914267650001	-	-	-
314270600001	314 270	914270601001	913183630121	914270650001	-	-	-
314281600001	314 281	921505601005	913183630121	914281650001	-	-	-
314283600001	314 278	914283601001	903078630121	914283650001	-	-	-
314287600001	314 287	914294601090	903078630121	914285650001	921504608001	-	-
314289600001	314 289	915055601001	913183630121	914289650001	-	914289631001	-
314293600001	314 293	935268601001	913183630121	914293650001	921504608001	-	-
314295600001	314 294	914294601090	903078630121	914295650001	-	914295605001	-
314305600001	314 305	914266601001	913183630121	914305650001	921504608001	-	-
314307600001	314 307	916128601090	903078630121	914307650001	921504608001	-	-
314310600001	314 310	907245601090	913183630121	914310650001	921504608001	-	-
314341600001	10.4210	907305601090	913183630121	-	932218608001	933051621090	-
314342600001	10.4213	907305601090	913183630121	-	932218608001	933051621090	-
314345600001	314 287	914294601090	921630630121	914285650001	921504608001	-	-
314346600001	314 293	935268601001	913183630121	914293650001	921504608001	-	-
314372600001	314 357	914357601090	921630630121	914373650001	921504608001	-	-
314377600001	314289	915055601001	903078630121	914289650001	-	914289631001	-
314386600001	314 350	914350601001	921630630121	914386650001	907292608001	-	-
314392600001	314 391	914391601009	921630630121	914391650001	921504608001	-	-
314397600001	314 305	914266601001	921630630121	914305650001	921504608001	-	-
314406600001	314 353	914294601090	903078630121	914406650001	907292608001	-	-
314406600011	314 353	914294601090	921630630121	914406650001	907292608001	-	-
314409600001	10.4214	913082601090	921630630121	-	932218608001	933051621090	-
314411600001	314 352	914354601009	921630630121	9144116650001	907292608001	-	-
314416600001	314 415	914357601090	921630630121	914416650001	907292608001	-	-
314420600001	314 371	907296601001	916114630120	914419650001	907292608001	-	-
314436600001	314 436	916128601090	913183630121	914307650001	921504608001	-	-
314437600001	314 354	914354601009	903078630121	914438650001	907292608001	-	-
314440600001	314 351	914357601090	921630630121	914440650001	907292608001	-	-
314448600001	314 444	914350601001	921630630121	-	-	-	-
314451600001	314 429	907296601001	913183630121	914451650001	907292608001	-	-
314461600001	40.4610	916165601090	913183630121	-	932218608001	933051621090	-
314470600001	314 459	914357601090	921630630121	914458650001	907292608001	-	-
314472600001	314 471	914294601090	903078630121	914472650001	907292608001	-	-
314473600001	314 464	914350601001	921630630121	914474650001	907292608001	-	-
314486600001	314 486	914266601001	913183630121	914305650001	921504608001	-	-
314500600001	314 287	914294601090	903078630121	914285650001	921504608001	-	-
314501600001	314 294	914294601090	903078630121	914295650001	921504608001	-	914295605001
314502600001	314 464	914350601001	921630630121	914474650001	907292608001	-	-
314503600001	314 354	914354601009	921630630121	914438650001	907292608001	-	-
314504600001	314 357	914357601090	921630630121	914373650001	921504608001	-	-
314505600001	314 415	914357601090	921630630121	914416650001	907292608001	-	-
314506600001	314 459	914357601090	921630630121	914458650001	907292608001	-	-
314507600001	314 391	914391601009	921630630121	914391650001	921504608001	-	-
314508600001	314 352	914354601009	921630630121	914414650001	907292608001	-	-
314509600001	314 351	914357601090	921630630121	914440650001	907292608001	-	-
314510600001	314 429	921405601090	913183630121	914451650001	907292608001	-	-
314513600001	314 488	914354601009	913183630121	914513650001	921504608001	-	-
314515600001	314 490	914493601005	921628630122	914515650001	914350600001	-	-
314540600001	314 429	921405601090	913183630121	914451650001	907292608001	-	-
314567600001	G121U	306245660001	913183630121	-	921504608008	933096621001	933096631001
314582600001	G125U	914294601090	913183630121	914581650001	921504608008	933096621001	933096631001
314584600001	G124U	913082601090	913183630121	914583650001	921504608008	933096621001	933096631001
314586600001	PG62U	914294601090	913183630121	914585650001	921504608008	933096621001	933096631001
314588600001	G127U	914294601090	913183630121	914587650001	921504608008	933096621001	933096631001
314597600001	PG66U	914251601090	913183630121	-	921504608008	933096621001	933096631001
314599600001	314599600001	914357601090	921630630121	-	907292608001	-	-
314601600001	G489	914294601090	913183630121	-	921504608001	933096621001	933096631001
314603600001	G901	907455601090	913183630121	914603650001	907292608001	-	-
314605600001	314605600001	907455601090	913183630121	914605650001	907292608001	-	-
315062600001	315 062	nicht mehr lieferbar	903011630108	915062650001	-	915062619004	-
315074600001	315 074	915074601001	903011630108	915074650001	-	-	-
315076600001	315 076	nicht mehr lieferbar	903011630108	915076650001	-	-	-
315080600001	315 080	nicht mehr lieferbar	914234630101	915079650001	-	-	-
315084600001	315 083 (A)	nicht mehr lieferbar	903011630108	915083650001	-	915083619001	-
315085600001	315 085	nicht mehr lieferbar	903011630108	915085650001	-	-	-
315088600001	315 088	nicht mehr lieferbar	903078630121	915088650001	-	-	-
315090600001	315 090	915055601001	913183630121	915090650001	-	-	-
315096600001	315 096	923045601005	903078630121	915095650001	-	-	-
315097600001	315 092	905112601001	903137630101	915097650001	-	-	-
315100600001	315 100	nicht mehr lieferbar	903011630108	915100650001	-	-	-
315103600001	315 103	914251601090	913183630121	915103650001	921504608001	-	-
315105600001	315 105	907200601005	913183630121	915105650001	-	-	-
315107600001	315 107	916165601090	913183630121	915107650001	921504608001	-	-
315109600001	315 109	923045601090	903078630121	915109650001	921504608001	-	-
315114600001	315 111	915114601007	933034630101	915113650001	-	-	-
315115600001	?	915115601070	933034630101	-	921545608001	-	-
315119600001	SI 065	923045601005	921630630121	-	-	-	-
315148600001	SI 043	915144601090	921630630121	-	-	-	-

Artikel-Nr. Anhängervorrichtung	Typ	Ersatz-Kugelstange	Verschlussstopfen	Zubehörrüte	Steckdosenhalter	Aufnehmerrohr & weitere Befestigungsteile	Halter für Steckdosenhalter & weitere Befestigungsteile
315150600001	SI 115	906187601005	913183630121	-	-	-	-
315152600001	SI 078	906224601001	903078630121	-	-	-	-
315158600001	03.4599	914251601090	913183630121	-	932218608001	933051621090	-
315171600001	03.4026	916128601001	921630630121	-	932218608001	933051621090	-
315175600001	SI 160	914251601090	913183630121	-	-	-	-
315178600001	03.4604	914251601090	913183630121	-	932218608001	933051621090	-
315182600001	SI 160	917034601005	921630630121	-	-	-	-
315185600001	SI 163	915185601001	921630630121	-	-	-	-
315187600001	SI 118	auf Anfrage / AHK Siarr	913183630121	-	-	-	-
315188600001	03.4611	915144601090	921630630121	-	932218608001	933051621090	-
315190600001	SI 208	915144601090	921630630121	-	-	-	-
315201600001	30.104	nicht mehr lieferbar	900001059080	-	-	-	-
315226600001	315 226	915226601090	921630630121	-	-	-	-
315244600001	315 226	915226601090	921630630121	-	921504608001	-	-
315246600001	SI237	915226601090	921630630121	-	-	-	-
315262600001	PG63AU	917034601090	913183630121	-	921504608001	933096621001	933096631001
315266600001	PG63AU	914294601090	913183630121	-	921504608001	933096621001	933096631001
315269600001	PG67U	914294601090	913183630121	-	921504608001	933096621001	933096631001
316097600001	316 097	906126601001	903011630108	916097650001	-	-	-
316100600001	316100	916100601001	903011630108	916100650001	-	-	-
316108600001	316 108	916108601001	903011630108	916107650001	-	-	-
316110600001	316 110	nicht mehr lieferbar	914234630101	916109650001	-	916109619001	-
316112600001	316 112	nicht mehr lieferbar	903011630108	916112650001	-	-	-
316114600001	316 114	916114601001	921630630121	916114650001	921504608001	-	-
316116600001	316 114	916114601001	921630630121	916114650001	921504608001	-	-
316117600001	316 117	916117601090	916114630120	916117650001	-	-	-
316137600001	316 137	913082601090	913183630121	916137650001	-	916137619001	-
316140600001	316 140	nicht mehr lieferbar	913183630121	916140650001	-	916140619001	-
316142600001	316 142	917016601005	913183630121	916142650001	-	916142619001	-
316152600001	316 152	921406601005	913183630121	916152650001	-	-	-
316156600001	316 156	915144601090	903078630121	916155650001	-	916155619101	-
316159600001	316 140	nicht mehr lieferbar	921630630121	916140650001	-	916140619001	-
316160600001	316 142	917016601005	921630630121	916142650001	-	916142619001	-
316162600001	316 145	917016601005	921630630121	916145650002	-	916145619001	-
316163600001	316 137	913082601090	921630630121	916137650001	-	916137619001	-
316166600001	316 166	906224601090	913183630121	916166650001	-	916166619101	-
316169600001	316 142	917016601090	921630630121	916142650001	-	916142619001	-
316170600001	316 170	916170601001	921630630121	916170650001	-	916143619001	-
316171600001	316 145	917016601090	921630630121	916145650002	-	916145619001	-
316176600001	316 176	914251601090	913183630121	916175650001	-	916175619101	-
316177600001	316 170	916170601001	913183630121	916177650001	-	916143619001	-
316186600001	316 128	916128601090	903078630121	916186650001	-	-	-
316192600001	316 189	907200601005	903078630121	916191650001	-	-	-
316194600001	316 165	916165601090	903078630121	916191650001	-	-	-
316197600001	316 199	916199601002	907286630001	916197650001	-	916199622001	907286626001
316207600001	316 207	906187601090	913183630121	916175650001	-	916206619101	-
316209600001	316 209	921505601005	913183630121	916209650001	-	-	-
316211600001	316 211	916211601001	921630630121	916213650001	-	-	-
316214600001	316 211	916211601001	916211630121	916213650001	-	-	-
316217600001	316 217	916217601002	907286630001	916216650001	-	916199622001	907286626001
316222600001	316 220	916220601007	933034630101	916222650001	-	-	-
316227600001	316 339	916225601001	921630630121	916226650001	921504608001	-	-
316252600001	316 250	916250601001	916211630121	916251650001	-	-	-
316262600001	SI 064	921441601005	921630630121	-	-	-	-
316265600001	SI 082	906224601001	903078630121	-	-	-	-
316267600001	SI 095	921556601005	921630630121	-	-	-	-
316269600001	SI 070	932262601007	921630630121	-	-	-	-
316273600001	SI 092	914251601090	913183630121	-	-	-	-
316278600001	SI 040	916250601001	921630630121	-	-	-	-
316284600001	SI 086	940067601007	921630630121	-	-	-	-
316287600001	SI 084	932262601007	921630630121	-	-	-	-
316291600001	SI 093	916298601007	921630630121	-	-	-	-
316294600001	SI 121	914251601090	913183630121	-	-	-	-
316297600001	SI 117	921556601005	921630630121	-	-	-	-
316307600001	SI 105	932262601007	921630630121	-	-	-	-
316310600001	SI 110	916276601001	921630630121	-	-	-	-
316312600001	SI 248	932262601007	921630630121	-	-	-	-
316315600001	SI 139	920057601090	921630630121	-	-	-	-
316320600001	SI 148	914251601090	913183630121	-	-	-	-
316322600001	SI 141	915144601090	921630630121	-	-	-	-
316324600001	SI 184	914251601090	913183630121	-	-	-	-
316326600001	316 325	916220601007	933034630101	916222650001	-	-	-
316334600001	SI 187	916335601001	921630630121	-	-	-	-
316335600001	SI 179	916335601001	921630630121	-	-	-	-
316337600001	SI 198	914294601090	921630630121	-	-	-	-
316342600001	SI 218	914294601090	921630630121	-	-	-	-
316344600001	SI 202	916276601001	921630630121	-	-	-	-
316355600001	SI 196	916335601001	921630630121	-	-	-	-
316359600001	SI 242	auf Anfrage / AHK Siarr	913183630121	-	-	-	-
316363600001	SI 203	921556601005	921630630121	-	-	-	-

Artikel-Nr. Anhängervorrichtung	Typ	Ersatz-Kugelstange	Verschlussstopfen	Zubehörrüte	Steckdosenhalter	Aufnehmerohr & weitere Befestigungsteile	Halter für Steckdosenhalter & weitere Befestigungsteile
31636600001	SI 215	920057601090	921630630121	-	-	-	-
316387600001	SI 234	907245601001	903078630121	-	-	-	-
316388600001	RN117U	-	-	916388650001	921504608001	-	933096631001
316389600001	RN117U	306245660001	913183630121	916388650001	921504608001	933096621001	933096631001
316391600001	SI 239	auf Anfrage / AHK Siarr	913183630121	-	-	-	-
316407600001	SI 252	907245601090	913183630121	-	-	-	-
316431600001	RN115U	-	-	916431650001	921504608001	-	933096631001
316432600001	RN115U	914294601090	913183630121	916431650001	921504608001	933096621001	933096631001
316447600001	RN116U	-	-	-	921504608001	-	933096631001
316448600001	RN116U	915144601090	913183630121	-	921504608001	933096621001	933096631001
316453600001	RN118U	-	-	916453650001	921504608001	-	933096631001
316454600001	RN118U	914266601001	913183630121	916453650001	921504608001	933096621001	933096631001
316471600001	RN119U	-	-	916471650001	921504608001	-	933096631001
316472600001	RN119U	914266601001	913183630121	916471650001	921504608001	933096621001	933096631001
316481600001	RN120U	-	-	-	921504608001	-	933096631001
316482600001	RN120U	916128601090	913183630121	-	921504608001	933096621001	933096631001
316487600001	RN121	913082601090	913183630121	-	921504608001	-	-
316490600001	DA771U	-	-	-	921504608001	-	933096631001
316491600001	DA771U	913082601090	913183630121	913082601090	921504608001	933096621001	933096631001
316494600001	RN908U	-	-	916494650001	921504608001	-	933096631001
316495600001	RN908U	932098601090	913183630121	916494650001	921504608001	933096621001	933096631001
316497600001	SI 272	905342601001	-	-	-	-	-
316500600001	DA1440U	-	-	916500650001	921504608001	-	933096631001
316501600001	DA1440U	914266601001	913183630121	916500650001	921504608001	933096621001	933096631001
317016600001	317 017	917016601090	903078630121	917016650001	-	-	-
317034660001	317 034	917034601090	921630630121	-	-	-	-
317035600001	317 034	917034601090	903078630121	-	-	-	-
317036600001	317 036	913082601090	921630630121	917036650001	-	-	-
317040600001	317 034	917034601090	921630630121	-	-	-	-
317046600001	317 046	917016601005	903078630121	917046650001	-	-	-
317047600001	317 044	917044601005	903078630121	917044650001	-	-	-
317056600001	317 056	nicht mehr lieferbar	903078630121	917056650001	-	-	-
317058600001	317 058	906224601090	903078630121	917056650001	-	-	-
317060600001	317 060	917016601090	903078630121	917046650001	921504608001	-	-
317064600001	317 064	921546601090	921630630121	921541650001	-	-	-
317066600001	317 066	921546601090	921630630121	917066650001	-	-	-
317075600001	317 058	906224601090	921630630121	917056650001	-	-	-
317079600001	317 077	917128601005	921630630121	917128650001	921504608001	-	-
317086600001	317 086	921546601090	921630630121	917086650001	-	-	-
317088600001	317 058	906224601090	903078630121	917088650001	-	-	-
317090600001	317 066	921546601090	921630630121	917066650001	-	-	-
317093600001	317 058	906224601090	921630630121	917088650001	-	-	-
317102600001	317 102	917088601090	921630630121	917088650001	917102608001	-	-
317105600001	317 077	917128601005	903078630121	917079650001	921504608001	-	-
317107600001	317 107	907336601090	921630630121	917106650001	921504608001	-	-
317114600001	317114	905405601001	921630630121	917086650001	921504608001	-	-
317117600001	317 077	917128601005	903078630121	917117650001	921504608001	-	-
317128600001	317 077	917128601005	903078630121	917128650001	921504608001	-	-
317130600001	317 130	907336601090	921630630121	917106650001	921504608001	-	-
317132600001	317 132	905405601001	921630630121	921738650001	921541608002	-	-
317134600001	SK31U	913082601090	913183630121	-	921504608001	933096621001	933096631001
317141600001	321 852	905405601001	921630630121	921862600001	932218608002	-	-
317157600001	VW82U	913082601090	913183630121	-	921504608001	933096621001	933096631001
317168600001	SK32U	913082601090	913183630121	-	921504608001	933096621001	933096631001
317170600001	SK33U	913082601090	913183630121	917169650001	921504608001	933096621001	933096631001
317172600001	SK34	913082601090	903078630121	-	932218608001	-	-
317174600001	---	935468601090	921630630121	-	907292608001	-	-
317184600001	---	903273601090	921630630121	-	907292608001	-	-
320040600001	320 040	920040601001	903078630121	920040650001	-	920040617001	920040609101
320042600001	320 042	906203601002	903011630108	920035650001	-	-	-
320044600001	320 044	nicht mehr lieferbar	903011630108	920044650001	-	920036607101	920044609101
320045600001	320 045	-	-	920045650001	-	920036607101	920044609101
320050600001	320 050	906224601090	913183630121	920050650001	-	920049606001	-
320053600001	320 050	916165601090	913183630121	920050650001	-	920049606001	-
320054600001	320 054	-	-	920054650001	-	920054606001	-
320057600001	320 057	920057601090	903078630121	920057650001	-	-	-
320060600001	320 060	906224601090	903078630121	920065650001	921504608001	-	-
320062600001	?	907286601007	921630630121	-	921545608001	-	-
320064600001	13.4206	913252601001	921630630121	-	900001005347	933054621090	-
320066600001	320 060	915055601001	903078630121	920065650001	921504608001	-	-
320068600001	320 068	914251601090	913183630121	920068650001	921504608001	-	-
320072600001	13.4607	916165601090	913183630121	-	932218608001	933051621090	-
320075600001	13.4259	916165601090	913183630121	-	932218608001	933051621090	-
320076600001	13.4260	907296601090	913183630121	-	932218608001	933051621090	-
320080600001	320 068	907200601005	913183630121	920068650001	921504608001	-	-
320097600001	13.4239	907329601090	921630630121	-	932218608001	933054621090	-
320102600001	320 102	913252601090	921630630121	-	932218608001	933054621090	-
320108600001	13.4288	907305601090	921630630121	-	932218608001	933051621090	-
320112600001	320 112	907296601090	921630630121	-	932218608001	933051621090	-
320114600001	320 114	914251601090	913183630121	920068650001	921504608001	-	-

Artikel-Nr. Anhängervorrichtung	Typ	Ersatz-Kugelstange	Verschlussstopfen	Zubehörtüte	Steckdosenhalter	Aufnahmerohr & weitere Befestigungsteile	Halter für Steckdosenhalter & weitere Befestigungsteile
320115600001	13.4305	913252601090	921630630121	-	932218608001	933054621090	-
320116600001	VL54U	-	-	920116650001	921504608001	-	933096631001
320117600001	VL54U	914251601090	913183630121	920116650001	921504608001	933096621001	933096631001
320118600001	13.0019	nicht mehr lieferbar	900001059080	-	-	-	-
320119600001	13.6022	nicht mehr lieferbar	900001059080	-	-	-	-
320167600001	VL54U	932098601090	913183630121	920116650001	921504608001	933096621001	933096631001
320169600001	VL56U	-	-	920169650001	921504608001	-	933096631001
320170600001	VL56U	932098601090	913183630121	920169650001	921504608001	933096621001	933096631001
320171600001	VL54U	-	-	920116650001	921504608001	-	933096631001
320172600001	VL54U	920057601090	913183630121	920116650001	921504608001	933096621001	933096631001
320173600001	VL54U	-	-	920116650001	921504608001	-	933096631001
320174600001	VL54U	306245660001	913183630121	920116650001	921504608001	933096621001	933096631001
320181600001	VL54U	-	-	920116650001	921504608001	-	933096631001
320182600001	VL54U	913082601090	913183630121	920116650001	921504608001	933096621001	933096631001
320187600001	---	906271601090	903137630101	-	907292608001	-	-
321330600001	321 330	907198601001	903078630121	921330650001	-	-	-
321399600001	321 399	921399601001	903011630108	921399650001	-	-	-
321405600001	321 405	921405601090	903078630121	921405650001	-	-	-
321407600001	321 407	nicht mehr lieferbar	903011630108	921407650001	-	-	-
321408600001	321 408	921408601001	903011630108	921408650001	-	-	-
321423600001	321 423	921423601001	914234630101	921423650001	-	-	-
321426600001	321 423	921423601001	921630630121	921423650001	-	-	-
321441600001	321 439	921441601005	903078630121	921441650001	-	-	-
321452600001	321 451	nicht mehr lieferbar	921630630121	921453650001	-	-	-
321453600001	321 451	nicht mehr lieferbar	903078630121	921543650001	-	-	-
321468600001	321 468	913129601001	903078630121	921468650001	-	-	-
321500600001	321 490	nicht mehr lieferbar	921630630121	-	-	-	-
321505600001	321 504	921505601005	903078630121	921505650001	-	-	-
321506600001	321 504	921505601005	921630630121	-	-	-	-
321508600001	321 507	921505601005	903078630121	921505650001	-	-	-
321523600001	321 522	921522601001	903078630121	921523650001	-	-	-
321525600001	321 495	921495601001	903137630101	921525650001	-	-	-
321526600001	321 495	921495601001	921630630121	-	-	-	-
321537600001	321 537	916128601090	903078630121	921537650001	921504608001	-	-
321540600001	321 540	916128601090	903078630121	921540650001	-	-	-
321543600001	321 541	921546601090	921630630121	921541650001	-	-	-
321545600001	321 534	nicht mehr lieferbar	921630630121	-	-	-	-
321545900005	321 534	921545601019	921630630121	-	-	-	-
321546600001	321 534	921546601090	921630630121	921546650001	921546608001	-	-
321546600999	321 534	921546601090	921630630121	921546650001	921546608001	-	-
321556600001	321 556	921558600003	903078630121	921673650001	-	-	-
321605600001	321 490	921605601015	903137630101	921605650001	-	-	-
321626600001	321 626	921522601001	903078630121	921626650001	-	-	-
321629600001	321 628	nicht mehr lieferbar	921630630121	-	-	-	-
321630600001	321 628	921546601090	921630630121	921630650001	-	-	-
321649600001	321 647	nicht mehr lieferbar	921630630121	-	-	-	-
321651600001	321 647	921546601090	921630630121	921651650001	-	-	-
321658600001	321 556	921558600003	921630630121	-	-	-	-
321659600001	321 556	921657601050	903078630121	921659650001	-	-	-
321660600001	?	nicht mehr lieferbar	921630630121	-	-	-	-
321670600001	321 490	nicht mehr lieferbar	921630630121	-	-	-	-
321673600001	321 556	921657601050	903078630121	921673650001	-	-	-
321675600001	?	921441601005	921630630121	-	-	-	-
321686600001	321 490	921605601005	921630630121	921686650001	-	-	-
321689900011	321 490	921605601005	921630630121	-	-	-	-
321691600001	321 668	921691601005	913183630121	921691650001	-	-	-
316165600001	316 165	916165601090	913183630121	-	-	-	-
321700600001	321 700	921546601090	921630630121	921700650001	-	-	-
321717600001	321 647	921546601090	921630630121	921651650001	-	-	-
321718600001	321 504	921505601005	921630630121	921505650001	-	-	-
321719600001	321 537	916128601090	921630630121	921537650001	921504608001	-	-
321720600001	321 540	916128601090	921630630121	921540650001	-	-	-
321721600001	321 534	921546601090	921630630121	-	-	-	-
321722600001	321 628	921546601090	921630630121	921630650001	-	-	-
321728600001	321 728	903189601090	913183630121	921727650001	-	-	-
321730600001	321 730	903292601019	921630630121	921730650001	-	-	-
321736600001	321 490	921605601015	903137630101	921736650001	-	-	-
321738600001	321 848	921546601090	921630630121	921738650001	932218608002	-	-
321748600001	321 740	921748601001	903078630121	921741650001	921504608001	921740650001	-
321751600001	321 751	903292601019	921630630121	921751650001	-	-	-
321775600001	321 439	921441601005	903078630121	921775650001	921504608004	-	-
321778600001	321 769	921546601090	921630630121	921778650001	932218608002	-	-
321782600001	321 854	921546601090	921630630121	921854650001	932218608002	-	-
321783600001	321 556	921657601050	921630630121	921673650001	-	-	-
321784600001	321 728	903189601090	921630630121	921727650001	-	-	-
321786600001	321 751	903292601019	921630630121	921751650001	-	-	-
321815600001	321 815	905405601001	921630630121	921814650001	921504608001	-	-
321823600001	321 816	921546601090	921630630121	921823650001	-	-	-
321838600001	321 537	916128601090	913183630121	921537650001	921504608001	-	-
321843600001	?	903292601019	921630630121	-	-	-	-

Artikel-Nr. Anhängervorrichtung	Typ	Ersatz-Kugelstange	Verschlussstopfen	Zubehörtüte	Steckdosenhalter	Aufnahmerohr & weitere Befestigungsteile	Halter für Steckdosenhalter & weitere Befestigungsteile
321863600001	321 852	921546601090	921630630121	921862600001	932218608002	-	-
321866600001	321 866	903292601019	921630630121	921865650001		-	-
321869600001	321 871	921546601090	921630630121	921868650001	932218608002	-	-
321873600001	321 873	903292601019	921630630121	921865650001		-	-
321878600001	321 740	921748601001	921630630121	921741650001	921504608001	-	921740650001
321879600001	321 740	auf Anfrage	921630630121			-	-
321885600001	321 866	903292601019	921630630121	921865650001		-	-
321907600001	321 907	913436601001	921630630121	921906650001	921504608001	-	-
321983600001	VW73U	913082601090	913183630121		921504608008	933096621001	933096631001
321991600001	VW73U	913082601090	913183630121		921504608008	933096621001	933096631001
322003600001	VW86U	916128601090	913183630121		921504608001	933096621001	933096631001
322055600001	VW90AU	913082601090	913183630121		921504608008	933096621001	933096631001
322056600001	VW95	329076600001	-		ZEP35	-	-
322064600001	VW96U	920057601090	913183630121	322063650001	921504608008	933096621001	933096631001
322070600001	VW90BU	913082601090	913183630121	922096650001	921504608008	933096621001	933096631001
322076600001	VW99U	914294601090	913183630121	322075650001	921504608001	933096621001	933096631001
322089600001	---	916128601090	913183630121		907292608001	-	-
322091600001	---	935468601090	921630630121		907292608001	-	-
322094600001	VW107	913252601090	921630630121		907292608001	-	-
322101600001	---	907335601001	921628630122		907292608001	-	-
322111600001	---	913252601090	921628630121		907292608101	-	-
322113600001	---	916128601090	921628630121		907292608001	-	-
322122600001	321 646	-	-	921651650001		-	-
322124600001	321 647	921628601001	921628630121	921651650001		-	-
322131600001	---		922131600101			-	-
322132600001	---		922131600101			-	-
306563600001	---		922131600101			-	-
313733600001	---		922131600101			-	-
323052600001	323 045	923045601090	905146630101	923052650001	-	-	-
323062600001	323 039	923062601001	923062630101	923062650001	-	923062650002	-
323063600001	323 051	329076600001	921630630121	923063650001	-	-	-
323079600001	323 079	907213601090	903078630121	923079650001	-	-	-
323080600001	323 080	923080601005	903078630121	923080650001	923080608002	-	-
323084600001	323 082	923045601090	903078630121	923084650001	921504608001	-	-
323097600001	323 097	923045601090	903078630121	923097650001	921504608001	-	-
323100600001	323 099	923045601090	903078630121	923084650001	921504608001	-	-
323102600001	23.4265	932276601090	921630630121	-	932218608001	933054621090	-
323107600001	323 107	921605601015	903137630101	923106650001	-	-	-
323107600011	323 107	921605601015	903137630101	923106650001	-	-	-
323121600001	323 121	921605601015	903137630101	923106650001	-	-	-
323121600011	323 121	921605601015	903137630101	923106650001	-	-	-
323141600001	323 141	913179601090	913183630121	-	932218608001	933051621090	-
323146600001	J19U	932098601090	913183630121		921504608001	933096621001	933096631001
323149600001	J17U	306245660001	913183630121		921504608001	933096621001	933096631001
323150600001	J17U	914251601090	913183630121		921504608001	933096621001	933096631001
323157600001	R54U	920057601090	913183630121		921504608001	933096621001	933096631001
323171600001	R55U	920057601090	913183630121		921504608001	933096621001	933096631001
323178600001	J20U	-	-	923178650001	921504608001	-	933096631001
323179600001	J20U	920057601090	913183630121	923178650001	921504608001	933096621001	933096631001
323181600001	R57U	920057601090	913183630121			933096621001	-
323189600001	R58U	-	-	923189650001	921504608001	-	933096631001
323190600001	R58U	914294601090	913183630121	923189650001	921504608001	933096621001	933096631001
323192600001	R59U	920057601090	913183630121		921504608001	933096621001	933096631001
324015600001	324 015 AUSF. A	nicht mehr lieferbar	914234630101		-	-	-
324019600001	324 019 AUSF. A	nicht mehr lieferbar	914234630101	924018650001	-	-	-
324021600001	324 021	924021601001	933020630101	-	-	-	-
324022600001	324 022	924022601007	933034630101	924022650001	-	-	-
324028600001	30.4249	914294601090	921630630121	-	921504608001	933051621090	-
327005600001	327 005	921605601015	903137630101	927014650001	-	-	-
327010600001	327 005	nicht mehr lieferbar	921630630121	-	-	-	-
327014600001	327 005	921605601015	903137630101	927014650001	-	-	-
327023600001	327 023	-	-	927023650001	-	-	-
327033600001	327 005	nicht mehr lieferbar	921630630121	927036650001	-	-	-
327036600001	327 005	921605601005	921630630121	927036650001	-	-	-
327068600001	327 068	907213601090	913183630121	-	932218608001	933051621090	-
332052600001	332 052	932052601001	921630630121	-	-	-	-
332058600001	332 052	932052601001	921630630121	-	-	-	-
332099600001	332 098	932099601001	921630630121	-	-	-	-
332119600001	332 119	915050601001	921630630121	932120650001	-	-	-
332121600001	332 121	915050601001	921630630121	932122650001	-	-	-
332122600001	332 121	915050601001	903011630108	932122650001	-	-	-
332123600001	332 123	nicht mehr lieferbar	921630630121	932124650001	-	-	-
332124600001	332 123	nicht mehr lieferbar	903011630108	932124650001	-	-	-
332134600001	332 134	nicht mehr lieferbar	921630630121	932134650001	-	-	-
332135600001	332 134	nicht mehr lieferbar	914234630101	932134650001	-	-	-
332154600001	332 153	nicht mehr lieferbar	903078630121	932154650001	-	-	932154606101
332186600001	332 176	932186601001	903078630121	932186650001	-	-	-
332198600001	332 198	921691601005	903078630121	932198650001	-	-	-
332205600001	332 205	-	-	932205650001	-	-	-
332206600001	332 206	914251601090	913183630121	932205650001	-	-	-

Artikel-Nr. Anhängervorrichtung	Typ	Ersatz-Kugelstange	Verschlussstopfen	Zubehörtüte	Steckdosenhalter	Aufnahmerohr & weitere Befestigungsteile	Halter für Steckdosenhalter & weitere Befestigungsteile
332207650001	332 207	-	-	932207650001	-	-	932195616001
332221600001	332 221	-	-	932221650001	-	-	-
332223600001	332 223	932223601090	903078630121	932223650001	-	-	-
332225650001	332 225	-	-	932225650001	-	-	-
332227600001	332 218	932218601005	903078630121	932227650001	932218608001	-	-
332228600001	332 220	-	-	932227650001	-	-	-
332230600001	332 229	-	-	932230650001	-	-	-
332232600001	332 231	907213601090	903078630121	932232650001	-	-	-
332234600001	332 233	-	-	932234650001	-	-	-
332235600001	332 235	907228601090	903078630121	932235650001	-	-	-
332237600001	332 237	-	-	932237650001	-	-	-
332239600001	332 238	-	-	932239650001	-	-	-
332241600001	332 240	932240601007	933034630101	932241650001	-	-	-
332245600001	332 245	-	-	932245650001	-	-	-
332246650001	332 246	-	-	932246650001	-	-	-
332247600001	332 247	907245601090	903078630121	932247650001	921504608001	-	-
332261600001	332 242	-	-	932261650001	-	-	-
332262600001	332 243	932262601007	933034630101	932262650001	-	-	-
332263650001	332 244	-	-	932263650001	-	-	-
332265600001	SI 132	932262601007	921630630121	-	-	-	-
332266600001	332 266	-	-	932246650001	-	-	-
332273600001	332 287	-	-	932273650001	-	-	-
332274600001	?	907228601090	921630630121	-	-	-	-
332296600001	31.4203	906187601005	913183630121	-	932218608001	933051621090	-
332303600001	332 289	932218601005	913183630121	932303650001	932218608002	-	-
332304600001	332 291	932276601090	921630630121	932304650001	921504608001	-	-
332305600001	332 292	932276601090	921630630121	932305650001	921504608001	-	-
332312600001	332 312	-	-	932312650001	-	-	-
332317600001	?	905305601001	921630630121	-	-	-	-
332318600001	?	933067601090	921630630121	-	-	-	-
332319600001	332 246	-	-	932319650001	-	-	-
332321600001	332 312	-	-	932321650001	-	-	-
332323600001	332 323	907213601090	913183630121	-	932218608001	933051621009	-
332324600001	?	932276601090	921630630121	-	-	-	-
332327600001	332 327	907245601090	903078630121	932247650001	921504608001	-	-
332330600001	332 330	915144601090	921630630121	-	-	-	-
332347600001	DT144AU	-	-	-	921504608008	-	933096631001
332348600001	DT144AU	914266601001	913183630121	-	921504608008	933096621001	933096631001
332353600001	DT148	329076600001	-	-	-	-	-
332359600001	DT152U	-	-	932359650001	921504608001	-	-
332360600001	DT152U	913082601090	913183630121	932359650001	921504608001	933096621001	-
332367600001	DT155	913082601090	913183630121	-	921504608001	-	-
332369600001	DT278U	913082601090	913183630121	932368650001	921504608001	933096621001	933096631001
335105600001	TY191U	-	-	935105650001	921504608001	-	933096631001
335106600001	TY191U	306245660001	913183630121	935105650001	921504608001	933096621001	933096631001
335129600001	335 129	nicht mehr lieferbar	921630630121	-	-	-	-
335184600001	335 184	915055601001	921630630121	-	-	-	-
335201600001	335 203	nicht mehr lieferbar	903011630108	935201650001	-	-	-
335203600001	335 203	nicht mehr lieferbar	921630630121	-	-	-	-
335210600001	335 209	nicht mehr lieferbar	903011630108	935208650001	-	-	-
335211600001	335 211	-	-	935211650001	-	-	-
335216600001	335 216	nicht mehr lieferbar	914234630101	935216650001	-	-	-
335218600001	335 218	nicht mehr lieferbar	903011630108	935218650001	-	-	-
335219600001	335 219	-	-	935219650001	-	-	-
335221600001	335 221	nicht mehr lieferbar	903011630108	935221650001	-	-	-
335223600001	335 223	-	-	935223650001	-	-	-
335230600001	335 229	-	-	935230650001	-	-	-
335236600001	335 218	nicht mehr lieferbar	921630630121	935218650001	-	-	-
335238600001	335 216	nicht mehr lieferbar	921630630121	935216650001	-	-	-
335239600001	335 239	nicht mehr lieferbar	913183630121	935239650001	-	-	-
335240600001	335 239	935239601001	916114630120	935239650001	-	-	-
335250600001	335 250	914259601005	903137630101	935250650001	-	-	-
335252600001	335 203	nicht mehr lieferbar	921630630121	935201650001	-	-	-
335256600001	335 225	nicht mehr lieferbar	921630630121	935225650001	-	-	-
335268600001	335 268	935268601001	921630630121	935268650001	-	-	-
335269600001	335 268	935268601001	921630630121	935268650001	-	-	-
335276600001	335 276	-	-	935276650001	-	-	-
335280650001	335 280	-	-	935280650001	-	-	-
335281600001	335 281	nicht mehr lieferbar	903011630108	935281650001	-	-	-
335282600001	335 282	935282601001	933020630101	935282650001	-	-	-
335284600001	335 284	-	-	935284650001	-	-	-
335285600001	335 285	916128601090	913183630121	935284650001	-	-	-
335286600001	335 286	-	-	935286650001	-	-	-
335288600001	335 288	-	-	935288650001	-	-	-
335289600001	335 289	916128601090	913183630121	935288650001	-	-	-
335290600001	335 290	-	-	935290650001	-	-	-
335294600001	335 294	-	-	935394650001	-	-	-
335295600001	335 295	913179601090	913183630121	935294650001	-	-	-
335299600001	335 299	-	-	935299650001	-	-	-
335300600001	335 299	329062600001	-	935299650001	-	-	-

Artikel-Nr. Anhängervorrichtung	Typ	Ersatz-Kugelstange	Verschlussstopfen	Zubehörtüte	Steckdosenhalter	Aufnehmerrohr & weitere Befestigungsteile	Halter für Steckdosenhalter & weitere Befestigungsteile
335302600001	335 302	923045601090	913183630121	935301650001	-	-	-
335303600001	335 303	-	-	935301650001	-	-	-
335304600001	335 304	923045601090	913183630121	935301650001	-	-	-
335305600001	335 305	935305601001	913183630121	935305650001	-	-	-
335309600001	335 304	923045601090	921630630121	935301650001	-	-	-
335322600001	335 322	-	-	935322650001	-	-	-
335323600001	335 323	906187601090	913183630121	935322650001	-	-	-
335324650001	335 324	-	-	935324650001	-	-	-
335325600001	335 325	917034601090	913183630121	935325650001	-	-	-
335327600001	335 327	915114601007	933034630101	935327650001	-	-	-
335328600001	335 328	-	-	935328650001	-	-	-
335329600001	335 329	-	-	935329650001	-	-	-
335334600001	335 334	916117601090	921630630121	935352650001	921504608004	-	-
335344600001	16.4782	916128601090	913183630121	-	-	932218608001	933051621090
335346600001	16.4783	916128601090	913183630121	-	-	932218608001	933051621090
335348600001	335 325	917034601090	913183630121	935325650001	-	-	-
335350600001	335 350	-	-	935350650001	-	-	-
335351600001	335 351	-	-	935351650001	-	-	-
335352600001	335 333	-	-	935352650001	-	-	-
335353600001	335 334	916117601090	913183630121	935352650001	921504608004	-	-
335355600001	335 355	917016601090	913183630121	935355650001	-	-	-
335357600001	16.4603	920057601090	913183630121	-	-	932218608001	933051621090
335358600001	16.4609	913179601090	913183630121	-	-	932218608001	933051621090
335360600001	16.4781	921546601090	921630630121	-	-	900001005347	933054621090
335363600001	335 363	-	-	935363650001	-	-	-
335365600001	335 365	-	-	935365650001	-	-	-
335364600001	335 374	nicht mehr lieferbar	903078630121	935363650001	-	-	-
335366600001	335 366	-	-	935366650001	-	-	-
335367600001	335 375	nicht mehr lieferbar	903078630121	935366650001	-	-	-
335368600001	335 368	-	-	935366650001	-	-	-
335383600001	335 383	916128601090	913183630121	935383650001	921504608001	-	-
335384600001	335 294	-	-	935398650001	-	-	-
335392600001	335 392	-	-	935392650001	-	-	-
335393600001	335 376	nicht mehr lieferbar	903078630121	935392650001	-	-	-
335394600001	335 394	-	-	935392650001	-	-	-
335397600001	335 299	-	-	935398650001	-	-	-
335398600001	335 295	913179601090	916114630120	935398650001	-	-	-
335400600001	335 400	-	-	935363650001	-	-	-
335408600001	335 328	-	-	935328650001	-	-	-
335409600001	335 328	-	-	935328650001	-	-	935409650001
335411600001	335 404	nicht mehr lieferbar	903078630121	935363650001	-	-	-
335414600001	16.4786	907305601090	913183630121	-	-	932218608001	933051621090
335418600001	335 418	-	-	935418650001	-	-	335417630002
335419600001	335 417	935417601002	921630630121	935418650001	-	-	335417630002
335421600001	335 420	935374601001	903078630121	935636650001	-	-	-
335423600001	335 423	916128601090	913183630121	935423650001	921504608004	-	-
335424600001	335 424	-	-	935423650001	-	-	-
335425600001	335 425	915055601001	921630630121	935423650001	921504608004	-	-
335450600001	16.4787	nicht mehr lieferbar	913183630121	-	-	932218608001	-
335455600001	335 383	916165601090	913183630121	935383650001	921504608001	-	-
335467600001	?	906423601001	921630630121	-	-	-	-
335495600001	335 495	917034601090	913183630121	-	-	921504608008	933096621001
335504600001	TY165A	329076600001	-	-	-	-	-
335505600001	TY183A	329076600001	ZEP12	-	-	-	-
335510600001	TY195U	-	-	935510650001	921504608001	933096621001	933096631001
335511600001	TY195U	913082601090	913183630121	935510650001	921504608001	933096621001	933096631001
335512600001	TY194U	-	-	935512650001	921504608001	933096621001	933096631001
335513600001	TY194U	306245660001	913183630121	935512650001	921504608001	933096621001	933096631001
335514600001	TY197U	-	-	-	-	933096621001	933096631001
335515600001	TY197U	914251601090	913183630121	-	-	933096621001	933096631001
338038600001	338 038	938038601005	903137630101	938038650001	-	-	-
338056600001	338 044	938044601001	921630630121	938056650001	-	-	-
338057600001	338 046	-	-	938057650001	-	-	-
338058600001	338 048	938058601001	907286630001	938058650001	-	-	-
338059600001	338 050	nicht mehr lieferbar	903011630108	938059650001	-	-	-
338064600001	338 063	-	-	938064650001	-	-	-
338062600001	338 061	nicht mehr lieferbar	921630630121	938062650001	-	-	-
338066600001	35.4201	916128601090	913183630121	-	-	900001005347	-
338081600001	35.4596	916117601001	921630630121	-	-	932218608001	933051621090
338091600001	338 091	-	-	938091650001	-	-	-
338092600001	338 092	938092601007	933034630101	938091650001	-	-	-
338103600001	338 101	-	-	938104650001	-	-	-
338104600001	338 098	916117601090	913183630121	938104650001	921504608001	-	-
338108600001	35.4291	921546601090	921630630121	-	-	932218608001	933054621090
338110600001	338 110	913082601090	921630630121	-	-	932218608001	933051621090
338116600001	35.4295	916117601090	913183630121	-	-	932218608001	933051621090
338120600001	338 120	921657601050	913183630121	-	-	932218608001	933051621090
338126600001	338 126	916128601090	913183630121	-	-	900001005347	933051621090
338127600001	HN74U	-	-	-	-	921504608008	933096631001
338128600001	HN74U	914251601090	913183630121	-	-	921504608008	933096631001

Artikel-Nr. Anhängervorrichtung	Typ	Ersatz-Kugelstange	Verschlussstopfen	Zubehörtüte	Steckdosenhalter	Aufnahmerohr & weitere Befestigungsteile	Halter für Steckdosenhalter & weitere Befestigungsteile
338130600001	HN73U	-	-		921504608001	-	933096631001
338131600001	HN73U	916128601090	913183630121		921504608001	933096621001	933096631001
340037600001	340 037	913097601009	903078630121	940037650001	-	-	-
340039600001	340 039	903078601001	903078630121	-	-	-	-
340040600001	340 040	915055601001	905063630103	940040650001	-	-	-
340044600001	340 037	913097601009	921630630121	940037650001	-	-	-
340045600001	340 039	903078601001	903078630121	940039650001	-	-	-
340046600001	340 040	915055601001	903078630121	940040650001	-	-	-
340048600001	340 048	-	-	940048650001	-	-	-
340052600001	340 052	940052601001	903078630121	940052650001	-	-	-
340054600001	340 054	-	-	940054650001	-	-	-
340055600001	340 055	-	-	940055650001	-	-	-
340056600001	340 056	-	-	940056650001	-	-	-
340057600001	340 057	nicht mehr lieferbar	921630630121	940057650001	-	-	-
340059600001	340 052	940052601001	921630630121	940052650001	-	-	-
340065600001	340 065	-	-	940065650101	-	-	-
340066600001	340 066	913199601001	913183630121	940066650001	-	-	-
340067600001	340 067	940067601007	933034630101	940067650001	-	-	-
340068600001	340 068	915115601070	933034630101	940068650001	-	-	-
340072600001	SI 060	914259601005	921630630121	-	-	-	-
340074600001	340 067	940067601007	933034630101	940067650001	-	-	-
340070600001	340 070	-	-	940070650001	-	-	-
340080600001	340 080	-	-	940080650001	-	-	-
340081600001	340 081	917016601090	913183630121	940081650001	921504608001	-	-
340093600001	37.4242	921546601090	921630630121	-	932218608001	933054621090	-
340094600001	37.4255	921546601090	921630630121	-	932218608001	-	-
340095600001	37.4240	921546601090	921630630121	-	-	-	-
340097600001	37.4272	921546601090	921630630121	-	932218608001	933054621090	-
340099600001	37.4286	907329601090	921630630121	-	932218608001	-	-
340131600001	CL127U	-	-	940131650001	921504608001	-	933096631001
340132600001	CL127U	916128601090	913183630121	940131650001	921504608001	933096621001	933096631001
341003600001	341 003	914259601005	903137630101	941003650001	-	-	-
341004600001	341 004	nicht mehr lieferbar	914234630101	941004650001	-	-	-
341006600001	341 006	915114601007	933034630101	941006650001	-	-	-
341016600001	48.5248	915115601070	933034630101	-	-	-	-
341018600001	48.4254	914257601001	921630630121	-	932218608001	-	-
341021600001	48.4250	907228601005	903078630121	-	-	-	-
341024600001	48.4306	915144601090	913183630121	-	932218608001	-	-
341030600001	48.0179	nicht mehr lieferbar	900001059080	-	-	-	-
341065600001	SZ26U	914251601090	913183630121	941065650001	921504608001	933096621001	933096631001
341066600001	SZ25	329076600001	-	-	900001005347	-	-
341067600001	SZ27Q	914259601005	942097630101	-	900001005347	-	-
341077600001	---	915144601090	913183630121	-	932218608001	-	-
342068600001	342 068	942068601002	914234630101	942068650001	-	-	-
342092600001	342 092	921505601005	903078630121	942092650001	-	-	-
342093600001	342 093	nicht mehr lieferbar	903137630101	942093650001	-	-	-
342097600001	342 097	923062601001	903137630101	-	-	921426601001	945009650001
342098600001	342 098	914259601005	903137630101	950350350001	933096631001	933096621001	933034621005
342099600001	SI 046	914259601005	921630630121	935230650001	923105608001/923114608001	938092601007	946020650002/933096631001/933096621019
342103600001	342 103	920057601090	913183630121	942207650001/ 900105632554/ 900110632505/ 900110636182/ 900115632524/ 900120632516/ 900130632539/ 900130636185/ 900135632379	923105608001/ 923114608001/ 920036608001/ 907480608002	946154300013/ 933096621019/ 915110608102/ 903186608001	933096631001
342105600001	SI 071	920057601090	921630630121	900040632340/ 900040636176/ 900045632325/ 900050632424/ 900050636186/ 900051351001/ 900055632552/ 900055636187/ 900060632523/ 900060636188/ 900095632553/ 900100632527/ 900100636180/ 900105632554/ 900110632505/ 900110632505/ 900115632524/ 900120632516/ 900130632539/ 900130636185/ 900135632379	903186608001/ 907480608002/ 914350608001/ 915110608102/ 920036608110/ 921259608101/ 921504608001/ 921504608002/ 921504608004/ 933034621005	906333621009/ 906350601007/ 933096621019/ 933096621001/ 938092601007	900010506616/ 933096631001

Artikel-Nr. Anhängervorrichtung	Typ	Ersatz-Kugelstange	Verschlussstopfen	Zubehörtüte	Steckdosenhalter	Aufnehmerrohr & weitere Befestigungsteile	Halter für Steckdosenhalter & weitere Befestigungsteile
342107600001	342 107	942107601007	933034630101	900040632340/ 900040636176/ 900045632325/ 900050632424/ 900050636186/ 900051351001/ 900055632552/ 900055636187/ 900060632523/ 900060636188/ 900095632553	913246608001/ 915110608102/ 932123608001/ 903186608001/ 907480608002/ 914350608001/ 917102608001/ 917102608001/ 921259608101/ 921504608001/ 921504608002/ 923105608001/ 923114608001/ 932218608001	906333621009/ 906350601007/ 933051621090/ 933054621090/ 906350601007/ 922038621009/ 922040621009/ 906333621009/ 906350601007/ 933096621001/ 933096621019/ 938092601007/ 906350601007/ 916220601007	906241650001/ 907289650001/ 933096631001
342113600001	SI 050	914259601005	921630630121	900040632340/ 900040636176/ 900045632325/ 900050632424/ 900050636186/ 900051351001/ 900055632552/ 900055636187/ 900060632523/ 900060636188/ 900095632553/ 900100632527/ 900100636180	903186608001/ 914350608001/ 915110608102/ 917102608001/ 920036608001/ 921259608101/ 921504608001/ 921504608002/ 921981608001/ 923105608001/ 923114608001/ 932218608001	906333621009/ 906350601007/ 907292608001/ 907480608002	900001506438/ 900010506616
342121600001		914251601090	913183630121		921545608001		
342131600001	49.4200	932223601090	913183630121	900040632340/ 900040636176/ 900045632325/ 900050632424/ 900050636186/ 900051351001/ 900055632552/ 900055636187/ 900060632523/ 900060636188/ 900095632553	903186608001/ 907292608001/ 907480608002/ 914350608001/ 907480608002/ 917102608001/ 920036608001/ 921504608001/ 921504608002/ 921981608001/ 923105608001/ 923114608001/ 932218608001/ 903186608001/ 907292608001/ 914350608001/ 915110608102/ 917102608001/ 920036608001/ 921504608001/ 921504608002/ 921981608001/ 923105608001/ 923114608001/ 932218608001/ 945150300013	906333621009/ 906350601007/ 93809601008/ 938092601007/ 906333621009/ 906350601007/ 933034621005/ 933051621090/ 933051621090/ 933054621090/ 933096621001/ 933096621019/ 938092601007/ 906350601007/ 906333621009/ 907292608001/ 933034621005/ 933051621090/ 933054621090/ 933096621001/ 933096621019/ 938092601007	914052605002/ 933096631001/ 900010506616/ 903127650001/ 933096631001
342136600001	342 127	942127601001	916211630121				
342162600001	48.0128	942162601010					
342178600001	314 355	913252601090	921630630121				
342183600001	36.4263	906187601005	913183630121				
342185600001	49.4258	907336601090	921630630121				
342188600001	36.4612	916128601001	921630630121				
342189600001	05.4238	nicht mehr lieferbar	913183630121				
342197600001	306 423	906423601001	921630630121				
342199600001	342 229	942127601001	921630630121				
342207600001	342 200	920057601090	913183630121				
342209600001	342 205	913179601090	913183630121				
342217600001	342 217	921546601090	921630630121				
342221600001	49.4309	907336601090	921630630121				
342235600001	49.0174	nicht mehr lieferbar	900001059080				
342277600001		914251601090	913183630121				
342302600001	CH27U	914294601090	913183630121	942301650001	921504608001	933096621001	933096631001
343020600001	343 023 (A)	-	-	943020650001	-	-	943020606003
343024600001	343 024	nicht mehr lieferbar	903078630121	-	-	-	-
343034600001	343 034	-	-	943034650001	-	-	-
343035600001		943035601001	921630630121				
343036600001	343 036	-	-	943034650001	-	-	-
343037600001	343 037	nicht mehr lieferbar	933020630101	943037650001	-	-	-
343038600001	307 265	915055601001	913183630121	943038650001	921504608001	-	-
343039600001	343 039	-	-	943039650001	-	-	-
343040600001	343 040	916117601090	913183630121	943039650001	-	-	-
343043600001	343 043	nicht mehr lieferbar	933034630101	943044650001	-	-	-
343044600001	343 044	nicht mehr lieferbar	933034630101	943044650001	-	-	-
343045600001	343 045	-	-	943045650001	-	-	-
343047600001	343 046	906187601090	913183630121	943047650001	921504608001	-	-
343053600001	27.0277	-	-	-	900001005347	-	-
343056600001	27.4277	913082601090	921630630121	-	932218608001	933051621090	-

Artikel-Nr. Anhängervorrichtung	Typ	Ersatz-Kugelstange	Verschlussstopfen	Zubehörrüte	Steckdosenhalter	Aufnahmerohr & weitere Befestigungsteile	Halter für Steckdosenhalter & weitere Befestigungsteile
343058600001	27.4205	906187601005	913183630121	-	932218608001	933051621090	-
343060600001	27.0154	-	-	-	900001005347	-	-
343063600001	343 061	907329601090	921630630121	943063650001	932218608002	-	-
343064600001	343 062	-	-	943063650001	-	-	-
343066600001	27.0236	-	-	-	900001005347	-	-
343067600001	27.4236	907296601090	913183630121	-	900001005347	933051621090	-
343070600001	27.0296	-	-	-	900001005347	-	-
343071600001	27.4296	913082601090	921630630121	-	932218608001	933051621090	-
343073600001	27.0311	-	-	-	900001005347	-	-
343072600001	343 072	-	-	943072650001	-	-	-
343074600001	27.4311	907329601090	921630630121	-	932218608001	-	-
343075600001	343 075	-	-	-	900001005347	-	-
343076600001	---	916128601090	913183630121	-	932218608001	933051621090	-
343078600001	27.4301	913082601090	921630630121	-	932218608001	933051621090	-
343079600001	343 079	-	-	943079650001	-	-	-
343080600001	27.4312	917034601090	913183630121	-	932218608001	933051621090	-
343081600001	27.0016	nicht mehr lieferbar	-	-	-	-	-
343088600001	343 088	916128601090	913183630121	-	-	-	-
343097600001	MZ56U	913082601090	913183630121	-	-	-	-
343101600001	MZ57U	914294601090	913183630121	-	-	-	-
343105600001	MZ60U	913082601090	913183630121	-	-	-	-
343111600001	MZ57AU	-	-	943114650001	921504608001	-	933096631001
343112600001	MZ57AU	914294601090	913183630121	943114650001	921504608001	933096621001	933096631001
343114600001	MZ61U	306245660001	913183630121	943114650001	921504608001	-	933096631001
343115600001	MZ61U	306245660001	913183630121	943114650001	921504608001	933096621001	933096631001
343117600001	MZ62U	-	-	943117650001	921504608001	-	933096631001
343118600001	MZ62U	913082601090	913183630121	943117650001	921504608001	933096621001	933096631001
344008600001	344 006	344006601001	903011630108	944006650001	-	-	-
344012600001		907198601001	921630630121	-	-	-	-
344017600001	321 399	921399601001	921630630121	-	-	-	-
344024600001	344 024	917016601090	903011630108	944023650001	-	-	-
344025600001	344 025	-	-	944025650001	-	-	-
344027600001	344 027	944019601001	903011630108	944027650001	-	-	-
344028600001	344 027	944019601001	921630630121	944027650001	-	-	-
344030600001	344 024	917016601090	921630630121	-	-	-	-
344031600001	344 019	904060601002	903011630108	944031650001	-	-	944031650002
344036600001	321 439	921441601005	921630630121	-	-	-	-
344039600001	344 039	944039601005	903078630121	944039650001	-	-	-
344040600001	344 040	-	-	944040650001	-	-	-
344043600001	344 043	-	-	944043650001	-	-	-
344044600001	344 044	944044601001	913183630121	944044650001	-	-	-
344048600001	344 048	913082601090	921630630121	944048650001	-	-	-
344050600001	344 050	907198601001	921630630121	944050650001	-	-	-
344051600001	344 044	944044601001	921630630121	-	-	-	-
344052600001	344 050	903292601019	921630630121	-	-	-	-
344053600001	344 053	-	-	944054650001	-	-	-
344054600001	344 054	932099601001	905146630101	944054650001	921504608001	-	-
344060600001	344 060	903292601019	921630630121	944060650001	-	-	-
344073600001	344 053	-	-	944073650001	-	-	-
344074600001	344 074	932099601001	905146630101	944073650001	921504608001	-	-
344079600001	344 079	903292601019	921630630121	944060650001	-	-	-
344093600001	VW89AU	-	-	-	921504608001	-	933096631001
344094600001	VW89AU	920057601090	913183630121	-	921504608001	933096621001	933096631001
344101600001	SA24AU	-	-	-	921504608001	-	933096631001
344102600001	SA24AU	913082601090	913183630121	-	921504608001	933096621001	933096631001
344110600001	SA25U	-	-	944110650001	921504608001	-	933096631001
344111600001	SA25U	920057601090	913183630121	944110650001	921504608001	933096621001	933096631001
344120600001	SA26	913252601090	921630630121	-	907292608001	-	-
344123600001	SA29	913252601090	921630630121	-	907292608001	-	-
344124600001	SA26	903273601090	921630630121	-	907292608001	-	-
345003600001	345 001	906126601001	903011630108	945001650001	-	-	-
345014600001	345 014	-	-	945014650001	-	-	-
345016600001	345 016	914259601005	903137630101	945016650001	-	-	-
345020600001	345 020	-	-	945020650001	-	-	945020609001
345021600001	345 021	921691601005	903078630121	945020650001	-	-	945020609001
345023600001		914266601001	921630630121	-	-	-	-
345025600001		903292601019	921630630121	-	-	-	-
345026600001	345 026	932240601007	933034630101	945026650001	-	-	-
345027600001	345 027	-	-	945027650001	-	-	-
345028600001	345 028	914257601090	903078630121	945028650001	-	-	-
345035600001	345 035	-	-	945035650001	-	-	-
345036600001	345 036	915144601090	903078630121	945035650001	-	-	-
345037600001	345 037	-	-	945037650001	-	-	-
345038600001	345 038	-	-	945038650001	-	-	-
345039600001	345 039	935305601001	903078630121	945039650001	921504608001	-	-
345041600001	345 041	-	-	945041650001	-	-	-
345047600001		914257601090	921630630121	-	-	-	-
345059600001	345 028	914257601090	903078630121	945059650001	-	-	-
345062600001	345 039	935305601001	921630630121	-	-	-	-
345065600001	44.4207	907305601090	913183630121	-	932218608001	933051621090	-

Artikel-Nr. Anhängervorrichtung	Typ	Ersatz-Kugelstange	Verschlussstopfen	Zubehörtüte	Steckdosenhalter	Aufnehmerohr & weitere Befestigungsteile	Halter für Steckdosenhalter & weitere Befestigungsteile
345068600001	44.4220	921546601090	921630630121	-	900001005347	933054621090	-
345069600001	44.0225	-	-	-	900001005347	-	-
345070600001	44.4225	907305601090	913183630121	-	932218608001	933051621090	-
345072600001	345 072	-	-	945018650001	-	-	-
345075600001	44.0216	-	-	900001005347	-	-	-
345077600001	44.4234	914251601090	913183630121	-	-	-	-
345078600001	44.8262	-	-	900001005347	-	-	-
345079600001	44.4251	917034601090	913183630121	-	-	-	-
345080600001	44.5262	942107601007	921630630121	-	-	933034621005	-
345081600001	44.8276	-	-	-	900001005347	-	-
345082600001	44.4276	916128601090	913183630121	-	932218608001	933051621090	-
345084600001	44.4264	906224601001	903078630121	-	-	-	-
345086600001	44.4283	914251601090	913183630121	-	932218608001	933051621090	-
345087600001	44.0268	-	-	-	900001005347	-	-
345088600001	44.0292	-	-	-	900001005347	-	-
345089600001	44.4292	914251601090	913183630121	-	932218608001	933051621090	-
345090600001	44.4285	906224601090	913183630121	-	932218608001	933051621090	-
345091600001	44.0304	-	-	-	900001005347	-	-
345092600001	44.4304	915144601090	913183630121	-	932218608001	-	-
345093600001	44.0294	-	-	-	900001005347	-	-
345094600001	44.4294	921546601090	921630630121	-	932218608001	933054621090	-
345096600001	345 096	907245601090	913183630121	-	932218608001	-	-
345111600001	345 111	-	-	-	900001005347	-	-
345112600001	345 112	914251601090	913183630121	-	932218608001	933051621090	-
345113600001	345 113	907305601090	913183630121	-	932218608001	933051621090	-
345115600001	345 115	906224601090	913183630121	-	932218608001	933051621090	-
345116600001	KA46U	-	-	903475650001	921504608001	-	933096631001
345117600001	KA46U	913082601090	913183630121	903475650001	921504608001	933096621001	933096631001
345118600001	345 118	-	-	-	900001005347	-	-
345119600001	345 119	907245601090	913183630121	-	921504608001	-	-
345126600001	KA45AU	-	-	-	921504608001	-	933096631001
345127600001	KA45U	306245660001	913183630121	-	921504608001	933096621001	933096631001
345128600001	KA41U	-	-	945128650001	921504608001	-	933096631001
345129600001	KA41U	914251601090	913183630121	945128650001	921504608001	933096621001	933096631001
345138600001	KA47U	-	-	945138650001	921504608001	-	933096631001
345139600001	KA47U	913082601090	913183630121	945138650001	921504608001	933096621001	933096631001
345140600001	KA48U	-	-	945140650001	921504608001	-	933096631001
345141600001	KA48U	917034601090	913183630121	945140650001	921504608001	933096621001	933096631001
345142600001	KA42AU	-	-	-	921504608001	-	933096631001
345143600001	KA42AU	913082601090	913183630121	-	921504608001	933096621001	933096631001
345144600001	KA49U	-	-	-	921504608001	-	933096631001
345145600001	KA49U	916128601090	913183630121	-	921504608001	933096621001	933096631001
345146600001	KA50U	-	-	945146650001	921504608001	-	933096631001
345147600001	KA50U	916128601090	913183630121	945146650001	921504608001	933096621001	933096631001
345151600001	KA51U	-	-	945151650001	921504608001	-	933096631001
345152600001	KA51U	914251601090	913183630121	945151650001	921504608001	933096621001	933096631001
345155600001	KA52U	-	-	-	921504608001	-	933096631001
345156600001	KA52U	914294601090	913183630121	-	921504608001	933096621001	933096631001
345165600001	KA53U	-	-	945165650001	921504608001	-	933096631001
345166600001	KA53U	932098601090	913183630121	945165650001	921504608001	933096621001	933096631001
345167600001	KA53AU	-	-	945167650001	921504608001	-	933096631001
345168600001	KA53AU	932098601090	913183630121	945167650001	921504608001	933096621001	933096631001
345171600001	KA1240U	-	-	945171650001	921504608001	-	933096631001
345172600001	KA1240U	932098601090	913183630121	945171650001	921504608001	933096621001	933096631001
345180600001	KA1443U	-	-	945180650001	921504608001	-	933096631001
345181600001	KA1443U	917034601090	913183630121	945180650001	921504608001	933096621001	933096631001
346015600001	346 015	-	-	946015650001	-	-	-
346016600001	346 016	923062601001	903137630101	946016650001	-	-	-
346017600001	-	nicht mehr lieferbar	921630630121	-	-	-	-
346018600001	346 018	-	-	946018650001	-	-	-
346019600001	346 019	946019601001	903078630121	946019650001	921504608001	-	-
346020600001	346 020	-	-	946020650001	-	-	946020650002
346021600001	346 021	921405601090	913183630121	946021650001	921504608001	-	946020650002
346024600001	346 024	915114601007	933034630101	946024650001	-	-	-
346025600001	346 025	-	-	946025650001	-	-	-
346026600001	346 026	915144601090	913183630121	946026650001	-	-	-
346041600001	346 041	-	-	946041650001	-	-	-
346047600001	46.0208	nicht mehr lieferbar	9000010059080	-	-	-	-
346049600001	46.4232	907305601090	913183630121	-	-	-	-
346057600001	46.5591	nicht mehr lieferbar	900001005405	-	-	-	-
346060600001	46.4222	914251601090	913183630121	-	-	-	-
346061600001	-	906187601005	913183630121	-	-	-	-
346064600001	46.4247	906224601090	913183630121	-	-	-	-
346066600001	-	915144601090	921630630121	-	-	-	-
346071600001	46.4271	914251601090	913183630121	-	932218608001	933051621090	-
346072600001	46.4270	914251601090	913183630121	-	-	-	-
346074600001	46.4282	914251601090	913183630121	-	932218608001	933051621090	-
346076600001	46.4287	921546601090	921630630121	-	-	-	-
346083600001	46.4281	915144601090	913183630121	-	-	-	-
346084600001	46.4284	906187601090	913183630121	-	-	-	-

Artikel-Nr. Anhängervorrichtung	Typ	Ersatz-Kugelstange	Verschlussstopfen	Zubehörtüte	Steckdosenhalter	Aufnehmerohr & weitere Befestigungsteile	Halter für Steckdosenhalter & weitere Befestigungsteile
346087600001	46.4313	913082601090	921630630121				
346088600001	46.4245	914251601090	913183630121				
346089600001	46.0545	nicht mehr lieferbar	900001059080				
346093600001		921556601005	921630630121				
346104600001	346 104	907213601090	913183630121				
346106600001	346 106	921657601050	913183630121				
346111600001	HY66U	-	-		921504608001	-	933096631001
346112600001	HY66U	306245660001	913183630121		921504608001	933096621001	933096631001
346122600001	HY69U	916128601090	913183630121				
346123600001	HY66AU	-	-		921504608001	-	933096631001
346124600001	HY66AU	306245660001	913183630121		921504608001	933096621001	933096631001
346125600001	HY70U	-	-		921504608001	-	933096631001
346126600001	HY70U	914294601090	913183630121		921504608001	933096621001	933096631001
346127600001	HY70AU	-	-		921504608001	-	933096631001
346128600001	HY70AU	914294601090	913183630121		921504608001	933096621001	933096631001
346155600001	HY71U	-	-	946155650001	921504608001	-	933096631001
346156600001	HY71U	916128601090	913183630121	946155650001	921504608001	933096621001	933096631001
346157600001	HY72U	-	-	946157650001	921504608001	-	933096631001
346158600001	HY72U	914251601090	913183630121	946157650001	921504608001	933096621001	933096631001
346163600001	HY70BU	-	-	946163650001	921504608001	-	933096631001
346164600001	HY70BU	916128601090	913183630121	946163650001	921504608001	933096621001	933096631001
346165600001	HY73U	-	-		921504608001	-	933096631001
346166600001	HY73U	932098601090	913183630121		921504608001	933096621001	933096631001
346172600001	HY291U	916128601090	913183630121	946172650001	921504608001	933096621001	933096631001
346173600001	HY291U	-	-	946172650001	921504608001	-	933096631001
346175600001	HY1270	915144601090	913183630121	946175650001	921504608001	-	-
348012600001	348 012	906115601001	903011630108				
348014600001		948014601001	933020630101				
348016600001	348 016	914251601090	913183630121				
348018600001	348 018	907329601090	903078630121				
348020600001	38.4191	nicht mehr lieferbar	900001005405	-	-	-	-
348022600001	38.4224	916128601001	921630630121				
348024600001	38.419	nicht mehr lieferbar	900001005405				
348026600001	38.4218	907305601090	913183630121				
348028600001	38.4219	903189601090	913183630121				
348035600001	348 035	932099601001	913183630121				
348036600001	38.4289	917088601090	921630630121				
348036600011	38.4289	917088601090	921630630121				
348037600001	38.4266	907336601090	921630630121				
348037600011	38.4266	907336601090	921630630121				
348039600001	38.4290	913252601090	921630630121	-	932218608001	-	-
348039600011	38.4290	913252601090	921630630121	-	932218608001	-	-
348063600001	348 063	913252601090	921630630121	-	932218608001	933054621090	-
348063600011	348 063	913252601090	921630630121	-	932218608001	933054621090	-
348065600001	348 065	907305601090	913183630121		932218608001	933051621090	-
348076600001	SU43U	920057601090	913183630121	948077650001	921504608001	933096621001	933096631001
348078600001	SU43U	920057601090	913183630121	948077650001	921504608001	933096621001	933096631001
348080600001	SU44U	914294601090	913183630121	948079650001	921504608001	933096621001	933096631001
348080600011	SU44U	914294601090	913183630121	948079650001	907292608001	933096621001	933096631001
348084600001	SU45U	913252601090	921630630121		907292608001	-	-
348086600001	SU47U	913252601090	921630630121		907292608001	-	-
348088600001	SU1305U	914294601090	913183630121	948087650001	907292608001	933096621001	933096631001
349025600001	349 025	921546601090	921630630121	949025650001	921504608001	-	-
349026600001	349 026	-	-	949026650001	-	-	-
349027600001	349 027	921546601090	921630630121	949026650001	921504608001	-	-
349037600001	349 025	921546601090	921630630121				
349033600001	349 033	-	-	949033650001	-	-	-
349038600001	349 038	-	-	949038650001	-	-	-
349039600001	349 039	907213601090	903078630121	949038650001	921504608001	-	-
351008600001	---	906245601090	921628630121	-	907292608001	-	-

Elektrosätze

Zubehör
Ersatzteile

Universal-Elektrosätze (12 V-Bordnetze)



Blinküberwachung durch Blinkgeber mit C2-Funktion

universell verwendbar für Fahrzeuge **ohne** Checkcontrol-System, mit europäischen 3-pol. Austauschblinkgeber mit C2-Anschluss, mit Nebelschlussleuchten-Abschaltung

Bestell-Nr.

300 060 300 107

300 060 300 113

300 061 300 113

300 096 300 163

(mit Adapter für abweichende Blinkgeberbelegungen)

(nur Leitungssatz für Fahrzeuge mit C2-Vorrüstung)



Blinküberwachung durch Steuergerät mit doppelter Blinkfrequenz

universell verwendbar für Fahrzeuge **ohne** Checkcontrol-System, mit Nebelschlussleuchten und Einparkhilfe-Abschaltung

Bestell-Nr.

300 052 300 113

(Steckdose mit Schraubkontakten, verlängerte Steckdosenzuleitung, z.B. für Pritsche)

300 073 300 113

(flache 40 mm-Steckdose mit Crimpkontakten und seitlichem Kabeleingang)



Blinküberwachung durch Steuergerät mit akustischer Fehlermeldung

universell verwendbar für Fahrzeuge **mit** Checkcontrol-System auch bedingt für Fahrzeuge mit Datenbustechnik (CAN), mit Nebelschlussleuchten und Einparkhilfe-Abschaltung

Bestell-Nr.

300 210 300 113

(Steckdose mit Schraubkontakten)

Ergänzungskits



Dauerplus- und Ladeleitung-Erweiterungskit

Beinhaltet den Anschluß für Kontakt 9, 10 und 11 nach DIN/ISO 11446 inkl. Absicherung und Trennrelais, 12V

Technische Daten:

- universaler E-Satz
- Anschluss vorne
- keine Blinküberwachung
- EPH-Abschaltung (Vorrüstung universell)
- Codierung nicht notwendig
- Dauerplus enthalten
- Ladeleitung enthalten

Art.-Nr.: 300 025 300 113



Checkcontrol-Ergänzungskit

(für einzelne BMW- und Opelmodelle)

Beinhaltet das Steuergerät (12V) inkl. Dauerplusanschluss und Absicherung für 10-polige Schnittstellen.

Art.-Nr.: 300 025 300 173



Dauerplus-Ergänzungskit "D1"

(Katalogbezeichnung "D1" in der 16. Tabellenspalte)

Beinhaltet den Anschluß für Kontakt 9 (13) nach DIN/ISO 11446 inkl. Absicherung

Art.-Nr.: 300 027 300 113



Ladeleitungs-Ergänzungskit "L1"

(Katalogbezeichnung "L1" in der 17. Tabellenspalte)

Beinhaltet den Anschluß für Kontakt 10 und 11 nach DIN/ISO 11446 inkl. Absicherung und Trennrelais, 12V

Art.-Nr.: 300 028 300 113



NSL/EPH Umschaltkit

Beinhaltet ein Umschaltrelais (12V) / Anschlußzubehör zur Änderung der Polarität der spezifischen Funktion, z.B. massegeschaltete Nebelschlußleuchten am Fahrzeug

Art.-Nr.: 300 065 300 005

Steuergeräte 12V – UCC-Steuergeräte

Steuergerät die mit dem CAN Netzwerk verbunden sind



Abbildungsbeispiel für UCC-Modul

Identifikations-Nummer (vom Original-Steuergerät)		ersetzt durch	Artikelnummer
506625	Uni CAN Control BMW UCC-1		900001506625
506626	Uni CAN Control PSA UCC-1 mit Buzzer		900001506626
506627	Uni CAN Control Ford UCC-1		900001506627
506628	Uni CAN Control Volvo UCC-1		nicht mehr lieferbar
506629	Uni CAN Control Daimler UCC-1		900001506629
506630	Uni CAN Control VW UCC-1		900001506630
506631	Uni CAN Control Opel UCC-1		900001506631
506632	Uni CAN Control Volvo UCC-2		nicht mehr lieferbar
506668	Uni CAN Control Volvo UCC-3		900001506668
506669	Uni CAN Control Volvo UCC-4		nicht mehr lieferbar
506670	Uni CAN Control MA/FO UCC-1		900001506670
506722	Uni CAN Control BMW UCC-3		nicht mehr lieferbar
506737	Uni CAN Control BMW UCC-2 (Auslaufteil)		900001506625
506738	Uni CAN Control Ford UCC-2		900001506738
506796	Uni CAN Control PSA UCC-2		nicht mehr lieferbar
506822	Uni CAN Control Daimler UCC-2		900001506822
506823	Uni CAN Control Fiat UCC-1 mit Buzzer		900001506823
506824	Uni CAN Control Fiat UCC 2		nicht mehr lieferbar
506867	Uni CAN Control Ford UCC-4		900001506867
506964	Uni CAN Control PSA UCC-3		900001506964
507005	Uni CAN Control Renault UCC V-1		900001507005
507007	Uni CAN Control BMW UCC HV-1		900001507007
507040	Uni CAN Control Daimler UCC V4.0		900001507040
507043	Uni CAN Control Daimler UCC V3		900001507043
507062	Uni CAN Control Ford UCC 5		900001507062
507097	Uni CAN Control VW UCC 2		nicht mehr lieferbar
507098	Uni CAN Control VW UCC 3		900001507098

Steuergeräte 12V – CAN-Module



Abbildungsbeispiel für
CAN-Modul

Identifikations-Nummer (vom Original-Steuergerät)		ersetzt durch	Artikelnummer
506156	CANSteuergerät DC Hella 5DS 008 895		900001506156
506171	CANSteuergerät DC Hella 5DS 008 102		nicht mehr lieferbar!
506173	CANSteuergerät DC Hella 5DS 008 493		900001506173
506195	CANSteuergerät DC		nicht mehr lieferbar!
506229	CANSteuergerät DC		nicht mehr lieferbar!
506248	CANSteuergerät DC		nicht mehr lieferbar!
300001 506573	CANSteuergerät DC	X	900001506873
300001 506873	CANSteuergerät DC		900001506873

Steuergeräte 12V – CAN-Module



Abbildungsbeispiel für
CAN-Module

Identifikations-Nummer (vom Original-Steuergerät)		ersetzt durch	Artikelnummer
506077	CANSteuergerät AAG	X	900001506758
506151	CANSteuergerät AAG	X	900001506758
506153	CANSteuergerät AAG	X	900001506758
506328	CANSteuergerät AAG	X	900001506758
506352	CANSteuergerät AAG	X	900001506758
300001 506553	CANSteuergerät AAG	X	900001506758
300001 506558	CANSteuergerät AAG	X	900001506758
300001 506658	CANSteuergerät AAG	X	900001506758
300001 506758	CANSteuergerät AAG		900001506758
300001 506194	CANSteuergerät AAG	X	900001506653
300001 506557	CANSteuergerät AAG		900001506557
300001 506560	CANSteuergerät AAG		900001506560
300001 506561	CANSteuergerät AAG	X	nicht mehr lieferbar!
300001 506562	CANSteuergerät AAG		900001506563
300001 506569	CANSteuergerät AAG		900001506569
300001 506667	CANSteuergerät AAG		900001506667
300001 506687	CANSteuergerät AAG		900001506569
300001 506697	CANSteuergerät AAG		900001506697
300001 506821	CANSteuergerät AAG		900001506821
300001 506710	CANSteuergerät AAGS		900001506710
300001 506790	CANSteuergerät AAGS		900001506790
300001 506869	CANSteuergerät AAGS	X	900001506869
300001 506870	CANSteuergerät AAGS		900001506870 (Auslaufteil)
300001 507025	CANSteuergerät AAGS		900001506869
300001 507012	CANSteuergerät AAGS		900001507012
300001 507014	CANSteuergerät AAGS		900001507014
300001 507015	CANSteuergerät AAGS		900001507015
300001 507016	CANSteuergerät AAGS		900001507016

Relais + Blinkgeber



NSL-Abschalt-Relais (z.B. DC E-Klasse)

30= Eingang (NSL-Schalter)
87a= Öffner Kontakt (NSL-Fahrzeug)
85= Ausgang Steckdose (NSL-Anhänger)

Art.-Nr.: 900 001 506 053



Blinkgeber (franz.), 4-polig (506148)

C=49a Ausgang Blinkgeber +=49 Eingang Blinkgeber -=31
Masse R=C 1. Kontrolleuchte
Kit mit C2-Leuchte und Kabel

Art.-Nr.: 900 001 506 147



Warnblinkschalter mit C2-Funktion (VW T4 ab 07/98)

Art.-Nr.: 900 001 506 287



Umschalt-Relais Mini-Bauform, z.B. Espace, Alfa, Fiat,... (506742)

1=86 Eingang Steuerleitung
2=85 Masse Steuerleitung
3=30 Eingang Schaltkontakt
4=87a Öffner Schaltkontakt
5=87 Schließer Schaltkontakt

Art.-Nr.: 900 001 506 742



Blinkgeber (europäisch), 3 polig + C2 (506811)

B=49 Eingang Blinkgeber
L=49a Ausgang Blinkgeber
E=31 Masse

Art.-Nr.: 900 001 506 811

Relais + Blinkgeber



Blinkgeber (europäisch), 3 polig + C2 (506811)

Kit mit C2-Leuchte und Kabel

B=49 Eingang Blinkgeber L=49a Ausgang Blinkgeber E=31
Masse

Art.-Nr.: 900 002 506 811

Zuordnung Steuergeräte und Steckdosen

Elektrosatz	Identifikationsnummer	Ersatz-Blinkgeber	Steckdose	
			7-polig	13-polig
Bestell-Nr.		Bestell-Nr.	Bestell-Nr.	Bestell-Nr.
300025300173	Steuergerät 10p 506079	nur kpl. mit E-Satz		
300052300107/113	Steuergerät 12p ALM12/1/ASTM12/ASG2000-121	900001506005	900001506424	900001506439
300056300107/113	Steuergerät 30p 506 270 A	900001506499	900001506424	900001506439
300060300107/113	Blinkgeber 3p+2p C2 506 811	900001506811	900001506424	900001506680
300061300107/113	Blinkgeber 3p+2p C2 506 811	900001506811	900001506424	900001506680
300061300107/113	Adapter	900061305001		
300070300107/113	Steuergerät 10p ALM 10/1 (alt: 582070002)	900001506274	900001506424	900001506680
300071300107/113	Steuergerät 22p (58 231 024)	900001506104	900001506054	900001506387
300072300107/113	Steuergerät 12p ALM12/1/ASTM12/ASG2000-121	900001506005	900001506397	900001506001
300073300113	Steuergerät 12p ALM12/1/ASTM12/ASG2000-121	900001506005	-	900001506124
300076300107/113	Steuergerät 22p ASG 2000-221	900001506434	900001506424	900001506439
300077300107/113	Steuergerät 22p 506 434	900001506434	900001506424	900001506439
300077300107/113	Steuergerät 30p 506 270 A	900001506499	900001506424	900001506439
300078300107/113	Steuergerät ASTM pro V4 (alt: ASTM pro C1)	900001506499	900001506424	900001506439
300080300107/113	Blinkadapter EKS 2000	900001506811	900001506424	900001506680
300200300113	Blinkgeber 30p 506691	900001506691	-	900001506439
300201300113	Steuergerät 22p ASTM LC	900001506633	-	900001506439
300210300107/113	Steuergerät 22p ASTM LC	900001506633	900001506424	900001506439
303056300107/113	Blinkgeber 4p Westfalia	900001507786	900001506397	900001506680
303116300107/113	Blinkgeber 8p 54 220 003	900001506961	900001506424	900001506680
303117300107/113	Blinkgeber 8p 54 220 003	900001506961	900001506424	900001506680
303119300107/113	Blinkgeber 8p 54 220 003	900001506961	900001506424	900001506680
303120300107/113	Blinkgeber 8p 54 220 003	900001506961	900001506424	900001506680
303121300113	Steuergerät 15p 6 908 767	900001506563	-	900001506439
303122300113	Blinkgeber 8p 54 220 003	900001506961	-	-
303123300113	Steuergerät 15p 8 369 019 / 6 908 767	900001506563	-	900001506439
303124300113	Steuergerät 15p 8 369 019 / 6 908 767	900001506563	-	900001506439
303127300113	Steuergerät 15p 8 369 019 / 6 908 767	900001506563	-	900001506439
303137300113	Steuergerät 15p 8 369 019 / 6 908 767	900001506563	-	900001506680
303140300107/113	Steuergerät 15p 8 369 019 / 6 908 767	900001506563	900001506384	900001506439
303180300107/113	Steuergerät 12p ALM12/1/ASTM12/ASG2000-121	900001506005	900001506424	900001506439
303189300113	Steuergerät 15p 8 369 019 / 6 908 767	900001506563	-	900001506439
303202300113	Steuergerät ASTM pro V4 (alt: ASTM pro C1)	900001506499	-	900001506386
303205300113	Steuergerät ASTM pro V4 (alt: ASTM pro C1)	900001506499	-	900001506387

Zuordnung Steuergeräte und Steckdosen

Elektrosatz	Identifikationsnummer	Ersatz-Blinkgeber	Steckdose	
			7-polig	13-polig
Bestell-Nr.		Bestell-Nr.	Bestell-Nr.	Bestell-Nr.
303235300113	Steuergerät ASTM pro V4 (alt: ASTM pro C1)	900001506499	-	900001506386
303240300113	Steuergerät ASTM pro V4 (alt: ASTM pro C1)	900001506499	-	900001506387
303338300107/113	Steuergerät BMW (alt:UCC-3) UCC-2	900001506737	900001506397	900001506001
303352300107/113	Steuergerät BMW UCC-HV-1	900001507007	900001506424	900001506439
303368300113	Steuergerät BMW UCC-HV-1	900001507007	-	900001506439
303372300113	Steuergerät BMW UCC-HV-1	900001507007	-	900001506439
303372300113	Steuergerät BMW UCC-HV-1	900001507007	-	900001506607
303450300113	Steuergerät 18+10p 506577 (5F001)	900001506577	-	900001506439
303451300107/113	Steuergerät BMW (alt:UCC-1) UCC-2	900001506737	900001506424	900001506439
303460300107/113	Steuergerät BMW (alt:UCC-1) UCC-2	900001506737	900001506424	900001506439
303461300113	Steuergerät 18+10p 506577 (5F001)	900001506577	-	900001506439
303481300113	UCC2.0 HS BMW (301142)	900001508158	-	900001506439
303516300113		508187	-	auf Anfrage
304047300107/113	Blinkgeber 3p+2p C2 506 811	900001506811	900001506424	900001506680
304054300107/113	Steuergerät 12p ALM12/1/ASTM12/ASG2000-121	900001506005	900001506424	900001506439
304060300107/113	Blinkgeber 3p+2p C2 506 811	900001506811	900001506424	900001506680
304061300107/113	Steuergerät 12p ALM12/1/ASTM12/ASG2000-121	900001506005	900001506424	900001506439
304064300107/113	Steuergerät 12p ALM12/1/ASTM12/ASG2000-121	900001506005	900001506424	900001506439
304144300113	Steuergerät PSA (alt. UCC-2) UCC-3	900001506964	-	900001506001
304152300107/113	Steuergerät PSA (alt. UCC-2) UCC-3	900001506964	900001506397	900001506001
304157300113	Steuergerät PSA UCC-3	900001506964	-	900001506439
304157300113	Steuergerät PSA_UCC-3	900001506964	-	900001506439
304157300113	506694	900001506694	900001506424	900001506439
304203300107/113	UCC2.0 LS OPEL PSA	900001508153	900001506424	900001506680
304400300107/113	WA_PSA_UCC-1	900001506626	900001506548	900001506439
304401300107/113	WA_PSA_UCC-1	900001506626	900001506548	900001506439
304402300107/113	WA_PSA_UCC-1	900001506626	900001506548	900001506439
304510300107/113	Blinkgeber 3p+2p C2 506 811	900001506811	900001506424	900001506680
305155300107/113	Blinkgeber 3p+2p C2 506811	900001506811	900001506424	900001506680
305161300107/113	Steuergerät 8p 321099/321105/321106	900001506252	900001506397	900001506386
305171300107/113	Steuergerät ASTM pro V4 (alt: ASTM 30)	900001506499	900001506424	900001506439
305177300107/113	Steuergerät 12p ALM12/1/ASTM12/ASG2000-121	900001506005	900001506397	900001506001
305179300107/113	Steuergerät 14p 321095	900001506399	900001506054	900001506386
305180300107/113	Steuergerät 12p ALM12/1/ASTM12/ASG2000-121	900001506005	900001506397	900001506001

Zuordnung Steuergeräte und Steckdosen

Elektrosatz	Identifikationsnummer	Ersatz-Blinkgeber	Steckdose	
			7-polig	13-polig
Bestell-Nr.		Bestell-Nr.	Bestell-Nr.	Bestell-Nr.
305191300107/113	Steuergerät ASTM pro V4 (alt: ASTM 30)	900001506499	900001506424	900001506439
305205300107/113	Steuergerät 10+14+14op 321133	900001506473	900001506397	900001506001
305206300107/113	Steuergerät ASTM pro V4 (alt: ASTM 30)	900001506499	900001506397	900001506001
305207300107/113	Steuergerät 14p 321095	900001506399	900001506054	900001506386
305208300107/113	Steuergerät ASTM pro V4 (alt: ASTM pro C1)	900001506499	900001506397	900001506001
305209300107/113	Steuergerät ASTM pro V4 (alt: ASTM pro C1)	900001506499	900001506397	900001506001
305210300107/113	Steuergerät 5DS 008 408-10	900001506101	900001506397	900001506124
305212300107/113	Steuergerät 506205	900001506205	900001506397	900001506124
305213300107/113	Steuergerät 506205	900001506205	900001506397	900001506124
305213300107/113	Steuergerät 300001506653	900001506653	900001506054	900001506386
305214300107/113	Steuergerät 300001506562	900001506653	900001506397	900001506124
305215300107/113	Steuergerät 5DS 008 408-10	900001506653	900001506054	900001506386
305216300107/113	Steuergerät 300001506557	900001506557	900001506397	900001506124
305220300107/113	Steuergerät 14p 321095	900001506399	900001506054	900001506386
305221300107/113	Steuergerät 12p ALM12/1/ASTM12/ASG2000-121	900001506005	900001506397	900001506001
305222300107/113	Steuergerät 30p ASTM 30	900001506275	900001506397	900001506001
305223300107/113	Steuergerät 12p ALM12/1/ASTM12/ASG2000-121	900001506005	900001506397	900001506001
305224300107/113	Steuergerät 10+14+14op 321133	900001506473	900001506397	900001506001
305226300113	Steuergerät AAG	900001506765	-	900001506386
305227300113	Steuergerät AAG	900001506765	-	900001506124
305228300107/113	Steuergerät 30p ASTM 30	900001506499	900001506424	900001506439
305255300107/113	Steuergerät AAG	900001506328	900001506424	900001506124
305256300107/113	Steuergerät 300001506558	900001506558	900001506397	900001506124
305268300113	Steuergerät 300001506560	900001506560	900001506397	900001506124
305269300107	Steuergerät AAG	900001506765	900001506397	-
305269300113	Steuergerät AAG	900001506479	-	900001506124
305272300107/113	Steuergerät AAG	900001506327	900001506397	900001506124
305329300107/113	1K0.907.383.F	900001506658	900001506344	900001506123
305330300107/113	1K0.907.383.F	900001506658	900001506344	900001506123
305384300113	4H0.907.383.C	900001506663	-	900001506123
305385300113	4G8.907.383	900001506710	-	900001506123
305385300113	Steuergerät Ersatzteil 4G8.907.383	900001506710	-	900001506710
305386300113	4G8.907.383	900001506710	-	900001506123
305387300113	Steuergerät AAG 2. Gen. 4G8.907.383.B	900001507015	-	900001506607

Zuordnung Steuergeräte und Steckdosen

Elektrosatz	Identifikationsnummer	Ersatz-Blinkgeber	Steckdose	
			7-polig	13-polig
Bestell-Nr.		Bestell-Nr.	Bestell-Nr.	Bestell-Nr.
305403300107/113	Steuergerät AAG	900001506821	900001506397	900001506617
305404300107/113	Steuergerät AAG	900001506821	900001506397	900001506617
305406300107/113	Steuergerät AAG	900001506821	900001506397	900001506617
305407300107/113	Steuergerät AAG 2. Gen. 5Q0.907.383.L	900001507014	900001506548	900001506607
305407300107/113	.300001507014	900001507014	900001506397	900001506607
305408300107/113	Steuergerät AAG 2	900001507014	900001506397	900001506617
305408300107/113	.300001507014	900001507014	900001506397	900001506607
305410300107/113	Steuergerät 506758	900001506153	900001506397	900001506124
305417300107/113	Steuergerät VW UCC V3	900001507098	900001506424	900001506617
305418300113	UCC2.0 HS VW-AG1 (301173)	900001508151		900001506607
305437300113	Steuergerät AAGS 2. Gen. 4M0.907.383.F	900001506870	900001506424	900001506617
305437300107/113	Steuergerät AAGS 2. Gen. 4M0.907.383.F	900001506870	900001506424	900001506617
305466300113	Steuergerät AAGS 2. Gen. 4M0.907.383.F	900001506870	-	900001506607
305486300107/113	Steuergerät AAGS 2. Gen. 4M0.907.383.F	900001506870	900001506424	900001506607
305486300113	Steuergerät AAGS 2. Gen. 4M0.907.383.F	-		900001506607
305500300113	Steuergerät AAG	900001506569	-	900001506387
306126300113	Steuergerät 16p 58 231 021/12V	900001506727	-	900001506680
306142300107/113	Blinkgeber 3p+2p C2 506811	900001506811	900001506424	900001506680
306150300107/113	Blinkgeber 3p+2p C2 506811	900001506811	900001506424	900001506680
306151300107/113	Blinkgeber 3p+2p C2 506811	900001506811	900001506424	900001506680
306152300107/113	Blinkgeber 3p+2p C2 506811	900001506811	900001506424	900001506680
306153300107/113	Blinkgeber 3p+2p C2 506811	900001506811	900001506424	900001506680
306154300107/113	Blinkgeber 3p+2p C2 506811	900001506811	900001506424	900001506680
306174300107/113	Steuergerät 12p ALM12/1/ASTM12/ASG2000-121	900001506005	900001506424	900001506439
306175300107/113	Steuergerät 30p 506270	900001506499	900001506424	900001506439
306186300107/113	Steuergerät 30p 506270	900001506499	900001506424	900001506439
306189300113	Steuergerät 30p 506270	900001506499	-	900001506439
306197300107/113	Blinkgeber 4p Westfalia	900001507786	900001506424	900001506680
306201300107/113	Blinkgeber 4p Westfalia	900001507786	900001506424	900001506680
306203300113	Steuergerät 16p 58 231 021/12V	900001506727	-	900001506680
306204300107/113	Steuergerät 30p 506270	900001506499	900001506424	900001506439
306215300107/113	Steuergerät 30p 506270	900001506499	900001506424	900001506439
306216300107/113	Steuergerät 12p ALM12/1/ASTM12/ASG2000-121	900001506005	900001506424	900001506439
306217300001	Steuergerät ALM12/1/ASTM12/ASG2000-121	900001506005	-	-

Zuordnung Steuergeräte und Steckdosen

Elektrosatz	Identifikationsnummer	Ersatz-Blinkgeber	Steckdose	
			7-polig	13-polig
Bestell-Nr.		Bestell-Nr.	Bestell-Nr.	Bestell-Nr.
306218300113	Steuergerät 30p 506691	900001506691	-	900001506386
306220300113	Steuergerät ASTM pro V4 (alt: ASTM pro C1)	900001506499	-	900001506386
306221300107/113	Steuergerät ASTM pro V4 (alt: ASTM pro C1)	900001506499	900001506397	900001506386
306224300107/113	Steuergerät ASTM pro V4 (alt: ASTM 31)	900001506499	900001506397	900001506386
306226300107/113	Steuergerät 12p ALM12/1/ASTM12/ASG2000-121	900001506005	900001506424	900001506439
306227300107/113	Steuergerät 12p ASTM 12	900001506005	900001506424	900001506438
306231300107/113	Steuergerät ASTM pro V4 (alt: ASTM 31)	900001506499	900001506424	900001506439
306237300107/113	Steuergerät ASTM pro V4 (alt: ASTM 31)	900001506499	900001506397	900001506001
306238300107/113	Steuergerät ASTM pro V4 (alt: ASTM 31)	900001506499	900001506424	900001506439
306239300113	Steuergerät ASTM pro V4 (alt: ASTM 31)	900001506499	-	900001506439
306240300107/113	Steuergerät ASTM pro V4 (alt: ASTM 31)	900001506499	900001506424	900001506439
306249300107/113	Steuergerät ASTM pro V4	900001506499	900001506397	900001506124
306252300107/113	Steuergerät ASTM pro V4 (alt: ASTM 31)	900001506499	900001506397	900001506386
306254300113	Steuergerät ASTM pro V4	900001506499	-	900001506124
306260300113	Steuergerät 30p 506270 A	900001506499	-	900001506124
306263300107/113	Steuergerät 30p 506270 A	900001506499	900001506397	900001506001
306265300107/113	Steuergerät ASTM pro V4	900001506499	900001506424	900001506439
306271300107/113	Steuergerät ASTM pro V4	900001506499	900001506424	900001506439
306311300113	ET-Modul ASTM V4F	900001507231	-	auf Anfrage
306353300113	Steuergerät 30p 506270 A	900001506499	-	900001506001
306371300107/113	Steuergerät ASTM pro V4	900001506499	900001506397	900001506124
306374300107/113	Steuergerät ASTM pro V4	900001506499	900001506397	900001506001
306375300107/113	Steuergerät UCC-1 Fiat		900001506424	900001506001
306383300113	Steuergerät ASTM pro V4	900001506499	-	900001506439
306392300113	Steuergerät ASTM pro V4	900001506499	-	900001506439
306394300107/113	Steuergerät ASTM pro V4	900001506499	900001506424	900001506439
306397300107/113	Steuergerät ASTM pro V4	900001506499	900001506424	900001506438
306441300113	Steuergerät ASTM pro V4	900001506499	-	900001506001
306451300113	UCC2.0 HS FCA	900001507189	-	900001506124
306467300113	Steuergerät ASTM pro V4	900001506499		900001506710
306469300113	Steuergerät ASTM PRO V4	900001506499	-	900001506123
306507300107/113	Blinkgeber 3p+2p C2 506811	900001506811	900001506424	900001506680
306508300107/113	Blinkgeber 3p+2p C2 506811	900001506811	900001506424	900001506680
306510300107/113	Steuergerät 30p 506270 A	900001506499	900001506424	900001506439

Zuordnung Steuergeräte und Steckdosen

Elektrosatz	Identifikationsnummer	Ersatz-Blinkgeber	Steckdose	
			7-polig	13-polig
Bestell-Nr.		Bestell-Nr.	Bestell-Nr.	Bestell-Nr.
306520300113	Steuergerät 12p ASTM 10	900001506542	-	900001506387
306527300113	Steuergerät ASTM pro V4	900001506499	-	900001506124
306530300107/113	Steuergerät 506270 A	900001506499	900001506424	900001506439
306531300107/113	Steuergerät 506270 A	900001506499	900001506424	900001506439
306531300107/113	Steuergerät 30p ASTM pro V4	900001506499	900001506424	900001506439
306540300113	Steuergerät 30p (ASTM pro C1 alt) ASTM V4	900001506499	-	900001506439
306550300107/113	Steuergerät 30p (ASTM pro C1 alt) ASTM V4	900001506499	900001506397	900001506386
306560300113	Steuergerät 30p (ASTM pro C1 alt) ASTM V4	900001506499	-	900001506386
306570300113	Steuergerät 506270 A	900001506499	-	900001506386
306580300113	Steuergerät 506270 A	900001506499	900001506424	900001506439
306590300107/113	Steuergerät Lancia	900001506691	900001506424	900001506439
306592300113	Steuergerät 7p 58 227 001	900001506540	-	900001506387
306605300107/113	Steuergerät ASTM pro V4	900001506499	900001506424	900001506439
306606300113	Steuergerät 506270 A	900001506499	-	900001506001
306640300107/113	Steuergerät ASTM pro V4	900001506499	900001506424	900001506439
307120300107/113	Steuergerät 12p ALM12/1/ASTM12/ASG2000-121	900001506005	900001506397	900001506386
307121300107/113	Steuergerät 12p ASTM 10	900001506542	900001506424	900001506439
307122300113	Steuergerät 14p 321059	900001506848	-	900001506439
307162300107/113	Blinkgeber 3p+2p C2 506811	900001506811	900001506424	900001506680
307194300107/113	Blinkgeber 3p+2p C2 506811	900001506811	900001506424	900001506680
307200300107/113	Steuergerät 12p ASTM 12	900001506005	900001506397	900001506386
307231300107/113	Steuergerät 12p ASTM 12	900001506005	900001506397	900001506386
307232300107/113	Steuergerät 12p ASTM 12	900001506005	900001506424	900001506438
307234300107/113	Steuergerät 10p/12p 5C006 / ASTM 12	900001506398	900001506397	900001506001
307234300107/113	Steuergerät 10p/12p 5C006 / ASTM 12	900001506005	900001506397	900001506001
307240300107/113	Steuergerät 12p ALM12/1/ASTM12/ASG2000-121	900001506005	900001506397	900001506386
307242300107/113	Steuergerät 12p ALM12/1/ASTM12/ASG2000-121	900001506005	900001506424	900001506439
307244300107/113	Steuergerät 12p ALM12/1/ASTM12/ASG2000-121	900001506005	900001506424	900001506439
307260300113	Steuergerät 12p ASTM 10	900001506542	-	900001506387
307260300107/113	Steuergerät 12p ALM12/1/ASTM12/ASG2000-121	900001506005	900001506424	900001506439
307264300107/113	Steuergerät 12p ALM12/1/ASTM12/ASG2000-121	900001506005	900001506397	900001506439
307280300107/113	Steuergerät 12p ALM12/1/ASTM12/ASG2000-121	900001506005	900001506397	900001506386
307290300107/113	Steuergerät 12p ALM12/1/ASTM12/ASG2000-121	900001506005	900001506397	900001506001
307360300107/113	Steuergerät 12p ALM 12/1 ASTM 10	900001506542	900001506397	900001506386

Zuordnung Steuergeräte und Steckdosen

Elektrosatz	Identifikationsnummer	Ersatz-Blinkgeber	Steckdose	
			7-polig	13-polig
Bestell-Nr.		Bestell-Nr.	Bestell-Nr.	Bestell-Nr.
307376300113	Flash Control - (2+1)* 21 W	900001506786	-	
307385300107/113	Steuergerät Ford UCC-4	900001506867	900001506424	900001506439
307386300107/113	Steuergerät Ford UCC-4	900001506867	900001506424	900001506439
307397300107/113	Steuergerät ASTM LC	900001506633	900001506397	900001506001
307400300107/113	Steuergerät Ford UCC-1	900001506627	900001506424	900001506439
307402300107/113	Steuergerät Ford UCC-2 506738	900001506738	900001506397	900001506001
307402300107/113	Steuergerät Ford UCC-2 506738	900001506738	900001506424	900001506439
307442300107/113	Steuergerät Ford UCC-2 506738	900001506738	900001506397	900001506001
307473300107/113	Steuergerät Ford UCC-2 506738	900001506738	900001506397	900001506001
307474300107/113	Steuergerät Ford UCC-2 506738	900001506738	900001506397	900001506001
307478300107/113	Steuergerät Ford UCC-5 506738	900001507062	900001506397	900001506001
307489300113	508157	900001508157	-	900001506493
307490300113	508157	900001508157	-	900001506680
307495300113	Steuergerät	900001507163	-	-
307499300107/113	Steuergerät Ford UCC-5 506738	900001507062	900001506397	900001506001
307500300107/113	Steuergerät Ford UCC-2 506738	900001506738	900001506424	900001506439
307522300113	Steuergerät 5C040	900001507042	-	900001506439
307556300113	Steuergerät Ford UCC-5 506738	900001507062	-	900001506439
307573300113	Steuergerät	900001507042	-	900001506439
307575300113	Steuergerät Ford UCC-5	900001507062	-	900001506439
307576300107/113	UCC2.0 HS Ford Ka+	900001508155	900001506424	900001506680
307624300113	UCC2.0 HS Ford 02 (301176)	900001508157		900001506439
313004300107	Kontrolleinheit 58 211 001	900001507401	900001506424	-
313053300107/113	Steuergerät 13p 5DK 004 087-02	900001507900	900001506424	900001506680
313061300107/113	Steuergerät 7p 58 227 001	900001506540	900001506424	900001506680
313067600107/113	Steuergerät 7p 58 227 001	900001506540	900001506424	900001506680
313072300107	Steuergerät 12p ALM12/1/ASTM12/ASG2000-121	900001506005	900001506424	-
313082300107/113	Steuergerät ASTM pro V4 (alt: ASTM 30)	900001506499	900001506424	900001506680
313084300107/113	Steuergerät 14p+22p ASG 2000-361	900001506447	900001506424	900001506439
313084300107/113	Steuergerät 14p+22p 321132 PA66GS30	900001506472	900001506424	900001506439
313101300107/113	Steuergerät 7p 58 227 01	900001506540	900001506424	900001506680
313103300107/113	Steuergerät 12p ALM12/1/ASTM12/ASG2000-121	900001506005	900001506424	900001506439
313105300107/113	Steuergerät 5DS 008 769-10	900001506172	900001506424	900001506439
313107300113	Steuergeraet AAG A906 900 99 01	900001507050	-	auf Anfrage

Zuordnung Steuergeräte und Steckdosen

Elektrosatz	Identifikationsnummer	Ersatz-Blinkgeber	Steckdose	
			7-polig	13-polig
Bestell-Nr.		Bestell-Nr.	Bestell-Nr.	Bestell-Nr.
313108300113	Steuergerät AAG A9069009901	900001507050	-	900001506439
313116300107/113	kein Steuergerät erforderlich, im Bordnetz integriert	-	900001506054	900001506387
313117300107/113	nicht lieferbar	-	900001506397	900001506386
313120300107/113	Steuergerät 10p ALM 10/1 (alt: 58207002)	900001506274	900001506424	900001506680
313120300107/113	Steuergerät 12p ALM12/1/ASTM12/ASG2000-121	900001506005	900001506424	900001506439
313121300107/113	Steuergerät 30p (ASTM pro C1 alt) ASTM V4	900001506499	900001506397	900001506386
313122300107/113	Steuergerät 5DS 008 769-10	900001506172	900001506424	900001506439
313134300113	nicht erforderlich	-	-	900001506386
313135300113	nicht erforderlich	-	-	900001506439
313138300113	nicht erforderlich	-	-	900001506438
313167300107/113	Steuergerät 5DS 008 102-107	900001506171	900001506424	900001506439
313168300107/113	Steuergerät 5DS 008 769-10	900001506172	900001506692	900001506439
313174300107/113	Steuergerät 12p ALM12/1/ASTM12/ASG2000-121	900001506005	900001506397	900001506001
313176300107/113	Steuergerät 30p 506 270	900001506499	900001506424	900001506439
313195300107/113	-	-	900001506397	900001506001
313196300107/113	Steuergerät 5DS 008 493-107	900001506173	900001506397	900001506386
313208300107/113	Steuergerät 506 156	900001506156	900001506397	900001506439
313210300107/113	Steuergerät 506 156	900001506156	900001506397	900001506124
313211300107/113	Steuergerät 300001506573	900001506573	900001506397	900001506124
313212300107/113	Steuergerät 300001506573	900001506573	900001506397	900001506124
313215300113	UCC2.0 HS Mercedes	900001508160	-	900001506680
313217300113	UCC2.0 HS Mercedes	900001508160	-	900001507180
313231300107/113	Steuergerät Daimler UCC-2 506822	900001506822	900001506424	900001506123
313234300107/113	Steuergerät 12p ALM12/1/ASTM12/ASG2000-121	900001506005	-	900001506438
313361300107/113	Steuergerät Daimler UCC-1	900001506629	900001506397	900001506124
313386300143	Steuergerät Daimler UCC-1	900001506629	-	900001506124
313398300107/113	Steuergerät Daimler UCC-1	900001506629	900001506424	900001506124
313406300113	Steuergerät Daimler UCC-1	900001506629	-	900001506124
313430300113	Steuergerät Daimler UCC-1	900001506629	-	900001506124
313432300107/113	Steuergerät Daimler UCC-4	900001507040	900001506397	900001506124
313436300107/113	Steuergerät Daimler UCC-3	900001507043	900001506397	900001506001
313445300113	UCC2.0 HS Mercedes	900001508160	-	900001507180
313446300113	UCC2.0 HS Mercedes	900001508160	-	900001507180
314237300107/113	Steuergerät 12p ALM12/1/ASTM12/ASG2000-121	900001506005	900001506424	900001506439

Zuordnung Steuergeräte und Steckdosen

Elektrosatz	Identifikationsnummer	Ersatz-Blinkgeber	Steckdose	
			7-polig	13-polig
Bestell-Nr.		Bestell-Nr.	Bestell-Nr.	Bestell-Nr.
314244300107/113	Steuergerät 12p ALM12/1/ASTM12/ASG2000-121	900001506005	900001506424	900001506439
314245300107/113	Steuergerät 14p/12p 321095	900001506399	900001506054	900001506387
314245300107/113	Steuergerät 14p/12p ASTM 12	900001506005	900001506054	900001506387
314250300107/113	Blinkgeber 3p+2p C2 506811	900001506811	900001506424	900001506680
314251300107/113	Blinkgeber 3p+2p C2 509811	900001506811	900001506424	900001506680
314253300107/113	Blinkgeber 3p+2p C2 509811	900001506811	900001506424	900001506680
314254300107/113	Blinkgeber 3p+2p C2 509811	900001506811	900001506424	900001506680
314256300107/113	Blinkgeber 3p+2p C2 509811	900001506811	900001506424	900001506680
314257300107/113	Blinkgeber 3p+2p C2 509811	900001506811	900001506424	900001506680
314257300107/113	Steuergerät 12p ALM12/1/ASTM12/ASG2000-121	900001506005	900001506424	900001506439
314263300107/113	Steuergerät 12p ALM12/1/ASTM12/ASG2000-121	900001506005	900001506424	900001506439
314263300107/113	Steuergerät 12p ASTM R	900001506623	900001506424	900001506439
314264300107/113	Steuergerät 12p ALM12/1/ASTM12/ASG2000-121	900001506005	900001506424	900001506439
314265300107/113	Steuergerät 12p ALM12/1/ASTM12/ASG2000-121	900001506005	900001506424	900001506439
314267300113	Steuergerät ASTM R	900001506623	-	900001506439
314274300113	Steuergerät 321054 / 321130	900001506862	-	900001506439
314275300107/113	Steuergerät 321054 / 321130	900001506862	-	900001506439
314283300107/113	Steuergerät 30p ASTM pro A1/C1/V4	900001506499	900001506424	900001506439
314289300107/113	Steuergerät 12p ALM12/1/ASTM12/ASG2000-121	900001506005	900001506424	900001506439
314295300113	Steuergerät 16p nur beim Opel-Händler erhältlich	-	-	900001506439
314300300107/113	Steuergerät 244 538 50	900001506907	900001506424	900001506438
314307300107/113	Steuergerät ASTM LC	900001506633	900001506424	900001506439
314335300113	Steuergerät ASTM R	900001506623	-	900001506439
314342300107/113	WA Opel UCC-1	900001506631	900001506424	900001506439
314364300113	nicht erforderlich		-	
314373300113	Steuergerät ASTM 10	900001503907	-	900001506439
314386300107/113	WA_Opel_UCC-1	900001506631	900001506424	900001506439
314390300113	nur beim Opel-Händler erhältlich	-	-	900001506387
314400300107/113	Steuergerät 30p ASTM pro A1/C1/V4	90001506499	900001506424	900001506439
314402300113	nur beim Opel-Händler erhältlich	-	-	900001506387
314422300113	Steuergerät ASTM LC	900001506633	-	900001506439
314436300107/113	WA_Opel_UCC-1	900001506631	900001506424	900001506439
314451300107/113	Steuergerät ASTM LC	900001506633	900001506424	900001506439
314513300107/113	WA_Opel_UCC-1	900001506631	900001506397	900001506001

Zuordnung Steuergeräte und Steckdosen

Elektrosatz	Identifikationsnummer	Ersatz-Blinkgeber	Steckdose	
			7-polig	13-polig
Bestell-Nr.		Bestell-Nr.	Bestell-Nr.	Bestell-Nr.
314513300107/113	WA_Opel_UCC-1	900001506631	900001506424	900001506680
314514300107/113	WA Opel UCC-1	900001506631	900001506424	900001506680
314580300113	Steuergerät UCC2.0 Opel PSA	900001508153	900001506424	900001506680
314585300113	508153	900001508153	-	900001506439
314594300107/113	UCC2.0 LS OPEL PSA (300757)	900001508153	900001506054	900001506680
314595300113	508153	900001508153	-	900001506439
314596300113	508153	900001508153	-	900001506680
314860300107/113	Steuergerät ASTM R	900001506623	900001506054	900001506387
314870300107/113	Steuergerät ASTM R	900001506623	900001506424	900001506439
315072300107/113	Blinkgeber 3p+2p C2 506811	900001506811	900001506424	900001506680
315073300107/113	Blinkgeber 3p+2p C2 506811	900001506811	900001506424	900001506680
315097300107/113	Blinkgeber 3p+2p C2 506811	900001506811	900001506424	900001506680
315109300107/113	Steuergerät PSA UCC-1 506626	900001506626	900001506424	900001506439
315110300107/113	Steuergerät PSA UCC-1 506626	900001506626	900001506397	900001506001
315157300113	Steuergerät PSA UCC-3	900001506964	-	900001506439
315182300113	Steuergerät PSA UCC-3	900001506964	-	900001506001
315185300113	Steuergerät PSA UCC-3	900001506964	-	900001506001
315196300113	Steuergerät PSA UCC-3	900001506964	-	900001506001
316113300107/113	Steuergerät 12p ALM12/1/ASTM12/ASG2000-121	900001506005	900001506397	900001506001
316114300113	Steuergerät 10p ALM 10/1 (alt: 58207002)	900001506274	-	900001506001
316114300113	Steuergerät 12p ALM12/1/ASTM12/ASG2000-121	900001506005	-	900001506001
316117300113	Steuergerät 10p ALM 10/1 (alt: 58207002)	900001506274	-	900001506680
316117300113	Steuergerät 12p ALM12/1/ASTM12/ASG2000-121	900001506005	-	900001506439
316118300107/113	Steuergerät 12p ALM12/1/ASTM12/ASG2000-121	900001506005	900001506424	900001506439
316120300107/113	Blinkgeber 4p+2p C2 70 BGi000	900001506147	900001506424	900001506439
316123300107/113	Steuergerät 12p ALM12/1/ASTM12/ASG2000-121	900001506005	900001506424	900001506439
316124300107/113	Blinkgeber 5p 54 201 126	900001507731	900001506424	900001506680
316126300107/113	Blinkgeber 5p 54 201 126	900001507731	900001506424	900001506680
316128300107/113	ALM12/1/ASTM12/ASG2000-121	900001506005	900001506424	900001506680
316130300107/113	Steuergerät ASTM 10	900001506542	900001506424	900001506439
316135300113	kein Steuergerät	-	-	900001506387
316140300107/113	Steuergerät 12p ALM12/1/ASTM12/ASG2000-121	900001506005	900001506397	900001506001
316142300107/113	Steuergerät 12p ALM12/1/ASTM12/ASG2000-121	900001506005	900001506397	900001506001
316143300107/113	Steuergerät 12p ALM12/1/ASTM12/ASG2000-121	900001506005	900001506397	900001506001

Zuordnung Steuergeräte und Steckdosen

Elektrosatz	Identifikationsnummer	Ersatz-Blinkgeber	Steckdose	
			7-polig	13-polig
Bestell-Nr.		Bestell-Nr.	Bestell-Nr.	Bestell-Nr.
316152300113	Steuergerät 12p ALM12/1/ASTM12/ASG2000-121	900001506005	900001506397	900001506001
316156300107/113	Steuergerät 12p ASTM 10	900001506542	900001506424	900001506439
316170300107/113	Steuergerät 12p ALM12/1/ASTM12/ASG2000-121	900001506005	900001506397	900001506001
316174300107/113	Steuergerät 12p ALM12/1/ASTM12/ASG2000-121	900001506005	900001506397	900001506001
316174300107/113	Steuergerät 12p ASTM R	900001506623	900001506397	900001506001
316176300113	Steuergerät 10p TLM C2+54	900001506730	-	900001506680
316187300107/113	Steuergerät 12p ALM12/1/ASTM12/ASG2000-121	900001506005	900001506397	900001506001
316190300107/113	Steuergerät ASTM R	900001506623	900001506424	900001506439
316192300107/113	Steuergerät 12p ALM12/1/ASTM12/ASG2000-121	900001506005	900001506424	900001506439
316205300107/113	kein Steuergerät	-	-	900001506680
316207300113	Steuergerät 321054 / 321130	900001506862	-	900001506001
316214300107/113	Steuergerät ASTM R	900001506623	900001506424	900001506439
316252300113	Steuergerät ASTM R	900001506623	-	900001506001
316259300113	Steuergerät 10p TLM C2+54	900001506730		
316273300107/113	Steuergerät ASTM LC	900001506633	900001506424	900001506439
316290300107/113	Steuergerät ASTM LC	900001506633	900001506054	900001506387
316294300107/113	Steuergerät ASTM LC	900001506633	900001506424	900001506439
316297300107/113	Steuergerät 22p LC	900001506633	900001506424	900001506439
316300300107/113	kein Steuergerät	-	900001506054	900001506387
316312300107/113	Steuergerät 30p ASTM V4 TD	900001507044	900001506424	900001506439
316315300107/113	Steuergerät 10p 506623	900001506623	900001506424	900001506439
316318300113	kein Steuergerät	-	-	900001506721
316319300113	kein Steuergerät	-	-	900001506123
316321300113	Steuergerät ASTM LC	900001506633	-	900001506439
316333300107/113	Steuergerät ASTM LC	900001506633	900001506424	900001506439
316334300107/113	Steuergerät ASTM LC	900001506633	900001506424	900001506439
316337300107/113	Steuergerät Renault UCC V1	900001507005	900001506424	900001506439
316338300107/113	Steuergerät ASTM LC	900001506633	900001506424	900001506439
316340300107/113	Steuergerät ASTM LC	900001506633	900001506424	900001506439
316353300107/113	kein Steuergerät	-	900001506054	900001506387
316359300107/113	Steuergerät ASTM PRO V4_TD	900001507044	900001506548	900001506439
316366300113	Steuergerät ASTM 12	900001506005	-	auf Anfrage
316368300107/113	Steuergerät ASTM PRO V4_TD	900001507044	900001506548	900001506439
316403300113	Steuergerät 785087		-	900001506439

Zuordnung Steuergeräte und Steckdosen

Elektrosatz	Identifikationsnummer	Ersatz-Blinkgeber	Steckdose	
			7-polig	13-polig
Bestell-Nr.		Bestell-Nr.	Bestell-Nr.	Bestell-Nr.
316404300113	Steuergerät 30p ASTM V4 TD	900001507044	-	900001506439
316407300113	Steuergerät	900001507174	-	900001506439
316410300113	Steuergerät 10p 506623	900001506623	-	900001506001
316430300107/113	Steuergerät ASTM LC	900001506633	900001506397	900001506001
316434300107/113	Steuergerät ASTM LC	900001506633	900001506548	900001506439
316437300113	Steuergerät ASTM PRO V4_TD	900001507044	-	900001506680
316440300107/113	kein Steuergerät	-	900001506054	900001506387
316442300107/113	Steuergerät 10p 900001506623	900001506623	900001506424	900001506439
316469300113	UCC2.0 HS Dacia Duster II	900001508154	900001506424	900001506680
316482300113	UCC2.0 HS RENAULT 2 (301474)	900001508165		900001506680
317007300107/113	Blinkgeber 4p Westfalia	900001507786	900001506424	900001506680
317013300107/113	Blinkgeber 4p Westfalia	900001507786	900001506424	900001506680
317015300107/113	Steuergerät 10p ALM 10/1 (alt: 58207002)	900001506274	900001506397	900001506001
317015300107/113	Steuergerät 12p ALM12/1/ASTM12/ASG2000-121	900001506005	900001506397	900001506001
317043300107/113	Steuergerät 12p ALM12/1/ASTM12/ASG2000-121	900001506005	900001506397	900001506001
317050300107/113	Steuergerät 12p ALM12/1/ASTM12/ASG2000-121	900001506005	900001506397	900001506001
317056300107/113	Steuergerät AAG (506328 alt) 506758	900001506758	900001506397	900001506617
317064300107/113	Steuergerät nicht erforderlich	-	900001506054	900001506617
317079300107/113	Steuergerät 506153	900001506153	900001506397	900001506617
317114300107/113	Steuergerät AAG2 300001507014	900001507014	900001506397	900001506607
317400300107/113	Steuergerät nicht erforderlich	-	900001506054	900001506617
317420300107/113	Steuergerät AAG 300001506758	900001506758	900001506397	900001506617
320039300107/113	Steuergerät nicht erforderlich	-	900001506424	900001506680
320044300107/113	Blinkgeber 3p+2p C2 506811	900001506811	900001506424	900001506680
320049300113	ohne Steuergerät/Lastrelais 506464	900001506464	-	900001506439
320051300113	Steuergerät 30p ASTM pro C1/V4	900001506499	-	900001506439
320058300113	Steuergerät 30p ASTM pro C1/V4	900001506499	-	900001506439
320076300107/113	Steuergerät Volvo UCC 3 506668	900001506668		900001506439
320102300107/113	Steuergerät 22p ASTM LC	900001506633	900001506424	900001506439
320108300107/113	Steuergerät ASTM LC	900001506633	900001506397	900001506001
320117300113	Steuergerät ASTM LC	900001506633	-	900001506439
320165300107/113	Steuergerät ASTM LC	900001506633	900001506548	900001506439
320173300107/113	UCC2.0 HS Volvo	900001508159	900001506424	900001506680
320187300113	Steuergerät EJH 321383	900001507356	-	auf Anfrage

Zuordnung Steuergeräte und Steckdosen

Elektrosatz	Identifikationsnummer	Ersatz-Blinkgeber	Steckdose	
			7-polig	13-polig
Bestell-Nr.		Bestell-Nr.	Bestell-Nr.	Bestell-Nr.
320240300107/113	Steuergerät 16p UCC 1 oder 3	900001506668	900001506424	900001506439
320320300113	Steuergerät 30p ASTM pro C1/V4	900001506499	-	900001506439
320400300113	Steuergerät 30p ASTM pro C1/V4	900001506499	-	900001506386
320540300113	Steuergerät 12p ALM12/1/ASTM12/ASG2000-121	900001506005	-	900001506001
320542300107/113	WA_Volvo_UCC-3	900001506668	900001506548	900001506438
320543300107/113	WA_Volvo_UCC-3	900001506668	900001506424	900001506680
320780300113	Steuergerät 12p ALM12/1/ASTM12/ASG2000-121	900001506005	-	900001506439
321044300113	Steuergerät VW UCC1 506630	900001506630	-	900001506124
321106300113	Steuergerät 5DS 008 769 - 107	900001506172	-	900001506439
321112300107/113	-	-	900001506424	900001506438
321113300107/113	Steuergerät AAG2 300001507012	900001507012	900001506424	900001506438
321315300107/113	Blinkgeber 3p+2p C2 506811	900001506811	900001506424	900001506680
321316300107/113	WBS 6NO 953 253 C	900001506287	900001506424	900001506680
321317300107/113	WBS 6NO 953 253 C	900001506287	900001506424	900001506680
321318300113	WBS 6NO 953 253 C	900001506287	900001506424	900001506680
321327300107/113	Blinkgeber 3p+2p C2 506811	900001506811	900001506424	900001506680
321331300107/113	Blinkgeber 3p+2p C2 506811	900001506811	900001506424	900001506680
321360300107/113	Blinkgeber 3p+2p C2 506811	900001506811	900001506424	900001506680
321361300107/113	Blinkgeber 3p+2p C2 506811	900001506811	900001506424	900001506680
321403300107/113	Blinkgeber 3p+2p C2 506811	900001506811	900001506424	900001506680
321451300107/113	ohne	-	900001506054	900001506387
321452300107/113	ohne	-	900001506054	900001506387
321454300107/113	Steuergerät 506758	900001506758	900001506054	900001506387
321455300107/113	Steuergerät 506558, 506658, 506758	900001506758	900001506054	900001506387
321456300107/113	Steuergerät 506558, 506658, 506758	900001506758	900001506054	900001506387
321457300107/113	Steuergerät 8p 321099/105/106	900001506252	900001506397	900001506001
321457300107/113	Steuergerät 12p 321099/105/106	900001506005	900001506397	900001506001
321458300107/113	Steuergerät 12p ALM12/1/ASTM12/ASG2000-121	900001506005	900001506397	900001506001
321465300107/113	Steuergerät 12p ALM12/1/ASTM12/ASG2000-121	900001506005	900001506397	900001506001
321468300107/113	WBS-Blinkgeber 1C0 953235 A	900001506022	-	900001506617
321500300113	Steuergerät AAG 506 107	900001506667	-	900001506439
321505300107/113	Steuergerät 12p ALM12/1/ASTM12/ASG2000-121	900001506005	900001506397	900001506001
321512300107/113	Steuergerät 12p ALM12/1/ASTM12/ASG2000-121	900001506005	900001506397	900001506001
321520300107/113	Steuergerät 12p ALM12/1/ASTM12/ASG2000-121	900001506005	900001506397	900001506001

Zuordnung Steuergeräte und Steckdosen

Elektrosatz	Identifikationsnummer	Ersatz-Blinkgeber	Steckdose	
			7-polig	13-polig
Bestell-Nr.		Bestell-Nr.	Bestell-Nr.	Bestell-Nr.
321523300113	ohne Steuergerät	-	-	900001506617
321524300107/113	ohne Steuergerät	-	900001506054	900001506617
321525300107/113	Steuergerät 506658, 506758	900001506758	900001506054	900001506387
321526300107/113	Steuergerät 12p ASTM 10	900001506542	900001506424	900001506439
321527300107/113	Steuergerät AAG 506658, 506758	900001506758	900001506397	900001506617
321529300107/113	Steuergerät AAG2 300001507012	900001507012	900001506397	900001506607
321534300107/113	Steuergerät AAG 506658, 506758	900001506758	900001506397	900001506617
321535300107/113	Steuergerät AAG 506658, 506758	900001506758	900001506397	900001506617
321537300107/113	Steuergerät AAG 506658, 506758	900001506758	900001506397	900001506617
321538300107/113	Steuergerät AAG 506658, 506758	900001506758	900001506397	900001506617
321539300107/113	Steuergerät 30p. ASTM PRO C1 / V4	900001506499	900001506397	900001506617
321540300107/113	Steuergerät AAG 506658, 506758	900001506758	900001506397	900001506617
321543300107/113	Steuergerät AAG 506658	506758, 900001506758	900001506397	900001506617
321545300107/113	Steuergerät AAG 506658, 506758	900001506758	900001506397	900001506617
321546300107/113	Steuergerät AAG 506658, 506758	900001506758	900001506397	900001506617
321554300107/113	Steuergerät AAG 506658, 506758	900001506758	900001506348	900001506438
321556300107/113	Steuergerät AAG 506658, 506758	900001506758	900001506054	900001506387
321557300107/113	Steuergerät 506658, 506758	900001506758	900001506054	900001506387
321600300107/113	Steuergerät 506658, 506758	900001506758	900001506397	900001506617
321650300113	Steuergerät 506758, 506758	900001506758	-	900001506387
321651300113	Steuergerät 506758	900001506758	-	900001506387
321652300113	-	-	-	900001506387
321653300113	-	-	-	900001506387
321661300113	-	-	-	900001506438
321681300113	Steuergerät UCC 2.0 LS VW-AG2	900001508179	-	auf Anfrage
321701300107/113	Steuergerät AAG 506658, 506758	900001506758		
321702300107/113	Steuergerät AAG 506658, 506758	900001506758	900001506054	900001506387
321704300107/113	Steuergerät 506758, 506758	900001506758	900001506054	900001506387
321705300113	Steuergerät AAG 300001506758	900001506758	-	900001506387
321765300113	Steuergerät AAG 7P0.907.383.B NAR	900001506660	900001506342	900001506438
321766300113	Steuergerät AAG2 300001507016	900001507016	-	900001506438
321780300107/113	Steuergerät VW UCC1 506630	900001506630	900001506397	900001506124
321863300107/113	Steuergerät VW UCC3 507098	900001507098	-	900001506617
321863300107/113	507098	900001507098	900001503424	900001506617

Zuordnung Steuergeräte und Steckdosen

Elektrosatz	Identifikationsnummer	Ersatz-Blinkgeber	Steckdose	
			7-polig	13-polig
Bestell-Nr.		Bestell-Nr.	Bestell-Nr.	Bestell-Nr.
322080300113			-	900001506607
322081300113			-	900001506607
323040300107/113	nicht erforderlich	-	900001506424	900001506680
323045300113	Steuergerät 15p 8 369 018/908 767	900001506563	-	900001506439
323048300107/113	ohne Steuergerät	-	90001506424	900001506680
323064300113	Steuergerät 15p 6 908 767	900001506563	-	900001506439
323074300113	nicht erforderlich	-	-	900001506437
323080300113	Steuergerät 30p (ASTM pro C1 alt) ASTM V4	900001506499	-	900001506124
323084300113	Steuergerät 506558	900001506558	-	900001506001
323097300113	Steuergerät BMW UUC2 506737	900001506625	-	900001506001
323102300113	nicht erforderlich	-	-	900001506617
323107300113	nicht erforderlich	-	-	900001506437
323141300113	nicht erforderlich	-	-	900001506439
323146300113	Steuergerät UCC	900001507150	-	900001507018
323189300113	UCC2.0 HS JLR 1 (301626)	900001508170		900001506439
323410300113	Steuergerät 506270 A	900001506499	-	900001506439
323411300113	nicht erforderlich	-	-	900001506607
324014300107/113	Steuergerät 14p 321095	900001506399	900001506054	900001506387
327014300113	Steuergerät 506 107	900001506107	-	900001506439
327068300113	Steuergerät AAG2 300001507016	900001507016	-	900001506001
332108300107/113	Steuergerät p3+2p C2 506811	900001506811	900001506424	900001506680
332262300107/113	Steuergerät ASTM LC	900001506633	900001506548	900001506439
332265300107/113	Steuergerät 12p ALM12/1/ASTM12/ASG2000-121	900001506005	900001506548	900001506439
332303300113	Steuergerät 5C018	nur kpl. mit E-Satz	-	900001506001
332305300113	Steuergerät ASTM LC	900001506633	-	900001506001
332306300113	Steuergerät 10p ASTM R	900001503907	-	900001506439
332314300113	Steuergerät ASTM LC	900001506633	-	900001506001
332327300107/113	Steuergerät ASTM LC	900001506633	900001506397	900001506001
332354300113	ET-Steuergerät Ejh 321264	900001507131	-	auf Anfrage
332366300113	Steuergerät ASTM LC	900001506633	-	900001506439
332367300113			-	900001506680
332400300107/113	Steuergerät 30p (ASTM 30 alt) ASTM V4	900001506499	900001506424	900001506439
332680300113	Steuergerät 10p 506079	nur kpl. mit E-Satz	-	900001506387
335110300113		-	-	-

Zuordnung Steuergeräte und Steckdosen

Elektrosatz	Identifikationsnummer	Ersatz-Blinkgeber	Steckdose	
			7-polig	13-polig
Bestell-Nr.		Bestell-Nr.	Bestell-Nr.	Bestell-Nr.
335229300113	Steuergerät 10p ASTM 10	900001506542	-	900001506438
335250300113	Steuergerät 10p ASTM R	900001506623	-	900001506439
335251300107/113	Steuergerät 10p ASTM 10	900001506542	900001506424	900001506439
335289300113	Steuergerät p3+2p C2 506811	900001506811	-	900001506439
335289300113	Flash Control - (2+1)*21 W	900001507786	-	900001506680
335299300113	Flash Control - (2+1)*21 W	900001507786	-	900001506680
335302300113	Steuergerät 10p ASTM 10	900001506542	-	900001506617
335303300113	Steuergerät 10p ASTM 10	900001506542	-	900001506617
335304300113	Steuergerät 10p ASTM 10	900001506542	-	900001506617
335305300113	Steuergerät 30p 506270 A	900001506499	-	900001506617
335323300113	Steuergerät 10p ASTM 10	900001506542	-	900001506617
335328300107/113	Steuergerät 12p ALM12/1/ASTM12/ASG2000-121	900001506005		900001506438
335345300113	Steuergerät ASTM V4	900001506499	900001506397	900001506001
335346300113	Steuergerät 5C028	900001506578	-	900001506439
335357300107/113	Steuergerät ASTM V4	900001506499	-	900001506001
335360300113	Steuergerät 5C028	900001506578	-	
335364300107/113	Steuergerät 22p 506633	900001506633	900001506397	900001506001
335383300107/113	Steuergerät ASTM V4	900001506499	900001506424	900001506439
335393300113	Steuergerät 5C028	900001506578	-	900001506439
335394300113	Steuergerät ASTM V4	900001506499	-	900001506439
335397300113	Steuergerät 22p 506633	900001506633	-	900001506439
335398300113	Steuergerät 5C033	900001506578	-	900001506439
335411300107/113	Steuergerät ASTM V4	900001506499	900001506397	900001506001
335413300107/113	Steuergerät ASTM V4	900001506499	900001506424	900001506439
335419300107/113	Steuergerät ASTM V4	900001506499	900001506424	900001506439
335423300107/113	Steuergerät ASTM V4	900001506499	900001506397	900001506001
335455300113	Steuergerät ASTM V4	900001506499	900001506397	900001506439
335456300113	Steuergerät	900001507131	-	900001506439
335494300113	Steuergerät 14p 321059	900001506848	-	-
335494300113	Steuergerät Blinkerüberwachung	900001507075	-	-
335600300113	Steuergerät 12p ASTM 10	900001506542	-	900001506617
338110300107/113	Steuergerät ASTM LC	900001506633	-	900001506001
338145300107/113	Steuergerät ASTM LC	900001506633	900001506548	900001506439
338680300113	Steuergerät 12p ALM12/1/ASTM12/ASG2000-121	900001506005	-	900001506438

Zuordnung Steuergeräte und Steckdosen

Elektrosatz	Identifikationsnummer	Ersatz-Blinkgeber	Steckdose	
			7-polig	13-polig
Bestell-Nr.		Bestell-Nr.	Bestell-Nr.	Bestell-Nr.
340072300113	Steuergerät 10p TLM C2+54	900001506639	-	900001506680
340075300113	Steuergerät 10p CCM	900001506079	900001506054	900001506386
340093300113	Steuergerät ASTM LC	900001506633	-	900001506439
340099300113	Steuergerät ASTM LC	900001506633	-	900001506001
340136300113	Steuergerät 9509	900001507091	-	900001506680
340144300113	UCC2.0 HS MITSUBISHI 01 (301365)	900001508164		900001506680
341016300113	Steuergerät 5C022	nur kpl. mit E-Satz	-	900001506680
341024300107/113	Steuergerät 12p ASTM 10	900001506542	-	900001506439
341049300107/113	Steuergerät ASTM LC	900001506633	900001506548	900001506439
341052300113	Steuergerät ASTM pro V4	900001508153	-	900001506439
341055300107/113	Steuergerät ASTM LC	900001506633	900001506424	900001506439
341059300113	Steuergerät ASTM LC	900001506633	-	900001506439
342033300107/113	Steuergerät ASTM LC	900001506633	-	900001506439
342041300107/113	Blinkgeber 4p Westfalia	900001507786	900001506424	900001506680
342097300113	Steuergerät 5C033 (alt 5C028)	900001506578	-	900001506439
342099300107/113	Steuergerät 12p ASTM 10	900001506542	900001506054	900001506387
342103300113	Steuergerät 5C033 (alt 5C028)	900001506578	-	900001506387
342105300113	506633	900001506633	-	900001506439
342184300113	Steuergerät 5C033 (alt 5C028)	900001506578	-	900001506680
342190300113	Steuergerät ASTM LC	900001506633	-	900001506439
342197300113	Steuergerät ASTM V4	900001506499	900001506397	900001506001
342200300113	Steuergerät ASTM LC	900001506633	-	900001506001
342239300113	nicht erforderlich	-	-	900001506680
342265300113	UCC2.0 HS FCA	900001507189	-	900001506124
343037300113	Steuergerät 12p ASTM 10	900001506542	-	900001506439
343056300107/113	Steuergerät ASTM LC	900001506633	900001506424	900001506439
343060300113	Steuergerät 12p ASTM 10	900001506542	-	900001506439
343063300113	Steuergerät 5D033 (alt 5C028,5C033)	900001506578	-	900001506387
343066300113	Steuergerät ASTM LC	900001506633	-	900001506124
343067300113	Flash Control - (2+1)*21 W	900001506744	-	900001506387
343069300113	Steuergerät UCC-1 MA/FO	900001506670	-	900001506439
343071300107/113	Steuergerät 5D033 (alt 5C028,5C033)	900001506578	-	900001506001
343074300113	Steuergerät ASTM LC	900001506633	-	900001506439
343076300113	Steuergerät 14p 321059	900001506848	-	-

Zuordnung Steuergeräte und Steckdosen

Elektrosatz	Identifikationsnummer	Ersatz-Blinkgeber	Steckdose	
			7-polig	13-polig
Bestell-Nr.		Bestell-Nr.	Bestell-Nr.	Bestell-Nr.
343076300113	Steuergerät Blinkerüberwachung	900001507075	-	-
343099300107/113	UCC2.0 HS Mazda CX	900001508152	900001506424	900001506680
343105300113	Steuergerät Blinkerüberwachung	900001507075	-	900001506680
343117300113			-	900001506680
343400300107/113	Steuergerät ASTM LC	900001506633	900001506424	900001506439
343660300113	Steuergerät 12p ASTM 10	900001506542	-	900001506386
343199300113	MFX ECS5F008 SW0411	900001500411	-	auf Anfrage
344023300107/113	Steuergerät 12p ALM12/1/ASTM12/ASG2000-121	900001506005	900001506397	900001506001
344027300107/113	Steuergerät 12p ALM12/1/ASTM12/ASG2000-121	900001506005	900001506424	900001506680
344040300107/113	ohne Steuergerät	-	900001506424	900001506680
344041300107/113	ohne Steuergerät	-	900001506424	900001506680
344044300107/113	Steuergerät AAG 506328, 506758	900001506758	900001506424	900001506617
344095300113	-	-	-	900001506607
344110300113	Steuergerät AAG2 300001507012	900001507012	-	900001506607
344110300113	507012	900001507012	-	900001506607
344111300137/143	Steuergerät AAG 2. Gen. 6C0.907.383.F	-	900001506054	900001506607
344250300107/113	Steuergerät 506558, 506758	900001506758	900001506397	900001506617
344500300107/113	Steuergerät AAG 506328, 506758	900001506758	900001506424	900001506439
344503300107/113	Blinkgeber 3p+2p C2 506811	900001506811	900001506424	900001506680
344504300107/113	Blinkgeber 3p+2p C2 506811	900001506811	900001506424	900001506680
345028300113	Steuergerät ASTM LC	900001506633	-	900001506439
345059300107/113	Steuergerät ASTM LC	900001506633	900001506055	900001506387
345066300113	Steuergerät ASTM LC	900001506633	-	900001506439
345068300113	Steuergerät ASTM LC	900001506633	-	900001506439
345069300113	Steuergerät ASTM LC	900001506633	-	900001506001
345070300113	TLM C2-FOG-REV-PDC (+)	900001506723	-	900001506680
345079300113	Steuergerät ASTM LC	900001506633	-	900001506439
345080300113	Steuergerät ASTM LC	900001506633	-	900001506439
345082300113	Steuergerät ASTM LC	900001506633	-	900001506439
345084300107/113	Steuergerät ASTM LC	900001506633	900001506397	900001506001
345086300107/113	Steuergerät ASTM LC	900001506633	-	900001506001
345086300107/113	Steuergerät ASTM LC	900001506633	900001506424	900001506439
345096300107/113	Steuergerät ASTM LC	900001506633	-	900001506001
345134300107/113	UCC2.0 HS Kia	900001508156	900001506424	900001506439

Zuordnung Steuergeräte und Steckdosen

Elektrosatz	Identifikationsnummer	Ersatz-Blinkgeber	Steckdose	
			7-polig	13-polig
Bestell-Nr.		Bestell-Nr.	Bestell-Nr.	Bestell-Nr.
345143300107/113	Steuergerät ASTM LC	900001506633	-	900001506001
345155300113	Steuergerät 24p., 507130	900001507130	-	900001506439
345168300113	Steuergerät ASTM LC	900001506633	-	900001506439
345169300113	Steuergerät ASTM LC	900001506633	-	900001506439
345171300107/113	Steuergerät ASTM LC	900001506633	900001506424	900001506439
345172300107/113	Steuergerät ASTM LC	900001506633	900001506424	900001506439
345173300113	Steuergerät 22p ASTM LC	900001506633	-	900001506439
345174300113	UCC2.0 HS Kia 01	900001508162	900001506424	900001506680
345220300107	Steuergerät 12p 506005	900001506005	900001506054	
345480300113	Steuergerät 12p ASTM 10	900001506542	-	900001506438
345481300113	Steuergerät 14p., 321059	900001506848	-	900001506680
345760300113	Steuergerät 12p ALM12/1/ASTM12/ASG2000-121	900001506005	-	900001506387
345880300113	Steuergerät 12p ALM12/1/ASTM12/ASG2000-121	900001506005	-	900001506124
345881300113	Steuergerät 12p ALM12/1/ASTM12/ASG2000-121	900001506005	-	900001506124
346018300107/113	Steuergerät 12p ASTM 10	900001506542	900001506424	900001506439
346049300107/113	Steuergerät ASTM LC	900001506633	900001506548	900001506439
346057300113	Steuergerät 5C022	nur kpl. mit E-Satz	-	900001506680
346059300113	Blinkgeber 3p+2p C2 506811	900001506811	-	900001506439
346064300107/113	Steuergerät ASTM LC	900001506633	900001506424	900001506439
346066300113	Steuergerät 12p ASTM 10	900001506542	-	900001506439
346071300113	Steuergerät ASTM LC	900001506633	-	900001506439
346076300107/113	Steuergerät ASTM LC	900001506633	-	900001506439
346142300107/113	Steuergerät ASTM LC	900001506633	900001506548	900001506439
346143300107/113	Steuergerät ASTM LC	900001506633	900001506548	900001506439
346145300113	Steuergerät ASTM LC	900001506633	-	900001506439
346146300107/113	Steuergerät 22p ASTM LC	900001506633	900001506424	900001506439
346800300107/113	Steuergerät 12p ASTM 10	900001506542	900001506424	900001506439
346810300107/113	Steuergerät 12p ASTM 10	900001506542	900001506424	900001506439
348020300113	Flash Control - (2+1)*21 W	900001507786	-	
348023300113	Flash Control - (2+1)*21 W	900001507786	-	
348026300113	Flash Control - (2+1)*21 W	900001507786	-	
348037300113	Steuergerät ASTM LC	900001506633	-	900001506439
348054300113	Steuergerät 14p., 321059	900001506848	-	900001506439
348055300113	Steuergerät 14p., 321059	900001506848	-	900001506439

Zuordnung Steuergeräte und Steckdosen

Elektrosatz	Identifikationsnummer	Ersatz-Blinkgeber	Steckdose	
			7-polig	13-polig
Bestell-Nr.		Bestell-Nr.	Bestell-Nr.	Bestell-Nr.
348062300113	Steuergerät 14p 321059	900001506848	-	
348073300113	Steuergerät 22p ASTM LC	900001506633	-	900001507018
349025300113	Steuergerät	900001506691	-	900001506439
349039300107/113	Steuergerät ASTM LC	900001506633	900001506054	900001506386
349049300113	Steuergerät ASTM LC	900001506633	-	900001506439
349053300113	Steuergerät ASTM LC	900001506633	900001506424	900001506439
351008300113		auf Anfrage	-	auf Anfrage
351009300113	Steuergerät ASTM LC	900001506633	-	auf Anfrage

Adapter + Stecker



Adapter 7/13

von PKW 7- auf Anhänger 13-polig

Art.-Nr.: 300 100 310 107



Kurz-Adapter 13/7

von PKW 13- auf Anhänger 7-polig

Art.-Nr.: 300 100 320 113



Stecker 13p.

Art.-Nr.: 900 001 506 533



Adapter 13p West

von PKW 13-polig (DIN/ISO 11446) auf Anhänger 7-/13-polig West

Art.-Nr.: 900 001 506 997

Steckdosen + Dichtungen



Steckdose 13-polig

(Option auf seitlichen Kabelausgang m. Dichtung
900001507101)
Schraubanschluß seitlicher Kabelausgang, mit NSL-
Abschaltkontakt

Art.-Nr.: 900 001 506 001



Steckdose 13-polig

Kontaktgehäuse mit Lötanschluß
2-Fachmicroschalter, axialer Kabelausgang

Art.-Nr.: 900 001 506 037



Steckdose 7-polig

Schraubanschluß, Microschalter Wechsler,
axialer Kabelausgang (N-Version DIN/ISO 1724)

Art.-Nr.: 900 001 506 054



Steckdose 13-polig

flache Version 40mm hoch, Crimpkontakte,
Microschalter, seitlicher Kabelausgang rechts

Art.-Nr.: 900 001 506 124



Steckdose 13-polig

Westsystem
Schraubanschluß ohne NSL-Abschaltkontakt,
axialer Kabelausgang ähnlich (N-Version DIN/ISO 1724) + 6
Kontakte

Art.-Nr.: 900 001 506 210



Steckdose 7-polig

Crimpanschluß, ohne NSL-Abschaltung, axialer
Kabelausgang (N-Version DIN/ISO 1724)

Art.-Nr.: 900 001 506 384



Steckdose 13-polig

Schraubanschluß
Microschalter
seitlicher Kabelausgang

Art.-Nr.: 900 001 506 386

Steckdosen + Dichtungen



Steckdose 13-polig

Schraubanschluß
Microschalter
axialer Kabelausgang

Art.-Nr.: 900 001 506 387



Steckdose 7-polig

Schraubanschluß, NSL-Abschaltkontakt,
seitlicher Kabelausgang rechts (N-Version DIN/ISO 1724)

Art.-Nr.: 900 001 506 397



Steckdose 7-polig

Schraubanschluß, NSL-Abschaltkontakt,
axialer Kabelausgang (N-Version DIN/ISO 1724)

Art.-Nr.: 900 001 506 424



Steckdose 13-polig

(Option auf seitlichen Kabelausgang m. Dichtung
900001507101)
Schraubanschluß axialer Kabelausgang, ohne NSL-
Abschaltkontakt

Art.-Nr.: 900 001 506 439



7p. Ergänzungsdose für den englischen Fahrzeugmarkt

(S-Version DIN/ISO 3732)

Art.-Nr.: 900 001 506 656



Steckdose 13-polig

(Option auf seitlichen Kabelausgang m. Dichtung
900001507101)
Schraubanschluß axialer Kabelausgang, mit NSL-
Abschaltkontakt

Art.-Nr.: 900 001 506 680

Zubehör Steckdosen



**Steckdosen-Dichtung mit Faltenbalg,
seitlicher Kabelausgang rechts (nicht für
900001-506439-506680-506001)**
(VPE 10 Stck.: Art.-Nr. 900 010 503 924)

Art.-Nr.: 900 001 503 924



Steckdosen-Dichtung
2 axiale Kabelausgänge

Art.-Nr.: 900 001 506 010



**Steckdosen-Dichtung mit Faltenbalg, axialer
Kabelausgang**
(VPE 10 Stck.: Art.-Nr. 900 010 506 024)

Art.-Nr.: 900 001 506 024



Ersatz-Steckdosengehäuse
52mm hoch, axialer Kabelausgang

Art.-Nr.: 900 001 506 438



**Dichtung für 900001-506439/680/001
seitlicher Ausgang rechts, 2 teilig**
(VPE 10 Stck.: Art.-Nr. 900 010 507 001)

Art.-Nr.: 900 001 507 001



Zusatz-Steckdosenblech
für 2. Steckdose (GB-Markt)

Art.-Nr.: 900 001 535 208



Kabeltülle abgewinkelt
für 40mm Karosserieöffnungen, Kabeldurchmesser
6-14mm, (VPE 10 Stk.)

Art.-Nr.: 900 010 303 015

Zubehör Steckdosen



Steckdosen-Dichtung (VPE 10 Stk.)

axialer Kabelausgang

Art.-Nr.: 900 010 506 531



Steckdosen-Unterlageblech (VPE 10 Stk.)

für geschlitzte Halter

Art.-Nr.: 900 010 506 616



Ersatz-Steckdosenhalter mit Schlitz universal

(VPE 10 Stck.: Art.-Nr. 920 036 608 110)

Art.-Nr.: 920 036 608 001



Ersatz-Steckdosenhalter universal

Art.-Nr.: 900 001 005 347



Steckdosenhalter klappbar

Ersatzteilkit Kunststoff
ohne Schlitz

Art.-Nr.: 921 504 608 001



Steckdosenhalter klappbar

Ersatzteilkit Kunststoff
mit Schlitz

Art.-Nr.: 907 292 608 001

Zubehör E-Sätze



Fahrzeugtester Anhängersimulation 12V
zur Funktionskontrolle und Fehlersimulation

Art.-Nr.: 900 001 300 198



Signalgeber
6-24V

Art.-Nr.: 900 001 300 200



C2-Leuchte kpl. 12V (kurze Version)
Lange Version: Art.-Nr. 900 001 507 809

Art.-Nr.: 900 001 506 547



Kabelverbinder
für Kabelquerschnitt 0,35-0,75mm² (VPE 4 Stk.)

Art.-Nr.: 900 001 506 102



Kabelverbinder
für Kabelquerschnitt 1,0-2,5mm² (VPE 10 Stk.)

Art.-Nr.: 900 010 507 391



Relaisadapter
(zur Anpassung unterschiedlicher Relaisbelegungen)

Art.-Nr.: 900 061 305 001



C2-Kabelbrücke
für ältere Opel-Fahrzeuge

Art.-Nr.: 914 083 303 020

Fahrradträgersystem **bikelander**

Zubehör
Ersatzteile

Fahrradträger + Zubehör



Fahrradträger bikelander

mit Hybrid-LED-Leuchten

- Abmessungen (BxHxT): 580x220x690 mm (eingeklappt) / 686x1250x678 mm (ausgeklappt)
- Eigengewicht: 17 kg
- max. Zuladung: 60 kg
- Radstand: bis 1300 mm
- Fahrradrahmen: bis 80 mm Durchmesser
- Reifenbreiten: bis 70 mm

Art.-Nr.: 350 050 600 001



Fahrradträger bikelander classic

mit konventionellen Leuchten

- Abmessungen (BxHxT): 580x220x690 mm (eingeklappt) / 686x1265x678 mm (ausgeklappt)
- Eigengewicht: 17 kg
- max. Zuladung: 60 kg
- Radstand: bis 1300 mm
- Fahrradrahmen: bis 80 mm Durchmesser
- Reifenbreiten: bis 70 mm

Art.-Nr.: 350 053 600 001



3er Fahrradträger

mit Hybrid-LED-Leuchten

- Abmessungen (BxHxT): 580x220x810 mm (eingeklappt) / 686x1250x678 mm (ausgeklappt)
- Eigengewicht: 20,5 kg
- max. Zuladung: 60 kg
- Radstand: bis 1300 mm
- Fahrradrahmen: bis 80 mm Durchmesser
- Reifenbreiten: bis 70 mm

Art.-Nr.: 350 065 600 001



Box (für BC 60, BC 70 & bikelander/classic)

Abmessungen (BxHxT): 1170x600x425 mm

Eigengewicht: 15 kg

max. Zuladung: 45 kg

Fassungsvolumen: 200 Liter

Farbe: anthrazit

Art.-Nr.: 350 002 600 001



Plattform (für BC 60, BC 70 & bikelander/classic)

Abmessungen (BxHxT): 1290x230x413 mm

Eigengewicht: 6 kg

max. Zuladung: 54 kg

Farbe: Anthrazit

Art.-Nr.: 350 004 600 001



Erweiterung 3. Fahrrad (für BC 60 & BC 70)

nicht für 3er Fahrradträger

Max. Zuladung: 20 kg

Gewicht: 5,5 kg

Radstand: bis 1300 mm

Art.-Nr.: 350 014 600 001



Erweiterungsatz für 3. Fahrrad (für bikelander/classic)

nicht für 3er Fahrradträger

Max. Zuladung: 20 kg

Gewicht: 5,5 kg

Radstand: bis 1300 mm

Art.-Nr.: 350 055 600 001

Fahrradträger + Zubehör



Auffahrschiene (für BC 60, BC 70 & bikelander/classic)

Schieben statt Heben von schweren Rädern
(für Model Portilo (- 12/11): Art.-Nr. 350 009 600 001 -> Auslaufmodell)

Art.-Nr.: 350 020 600 001



Tasche

Zum sauberen Verstauen des Fahrradträgers

Tasche für 2-er Fahrradträger

Art.-Nr.: 350 013 600 001

Tasche für 3-er Fahrradträger

Art.-Nr.: 350 017 600 001



Wandhalter (für BC 60, BC 70 und bikelander/classic))

Metallaufhängung zur Befestigung an jeder beliebigen Wand

Art.-Nr.: 350 006 600 001



Zusatzbremsleuchte (für BC 60, BC 70 & bikelander/classic)

Erforderlich, falls die Fahrräder die 3. Bremsleuchte des Fahrzeuges verdecken.

Flexible Befestigung am hinteren Fahrrad

Art.-Nr.: 350 000 305 173



Zahnriemenverlängerung (für BC 60, BC 70 & bikelander/classic)

(VPE 2 Stck.)

Art.-Nr.: 950 000 622 003



Hitzeschutz

Art.-Nr.: 350 005 600 001



Präsentationsständer (für BC 60, BC 70 & bikelander/classic)

(Fahrradträger gehört nicht zum Lieferumfang)

Art.-Nr.: 950 003 631 001

Fahradträger Ersatzteile



Leuchte (für BC 60, BC 70 & bikelander classic)

links kpl. (ohne Kabel)

Art.-Nr.: 950 000 302 003



Leuchte (für BC 60, BC 70 & bikelander classic)

rechts kpl. (ohne Kabel)

Art.-Nr.: 950 000 302 004



Leuchte (für bikelander)

links kpl. (ohne Kabel)

Art.-Nr.: 950 050 306 001



Leuchte (für bikelander)

rechts kpl. (ohne Kabel)

Art.-Nr.: 950 050 306 002



Leuchte li. & re. (für bikelander)

inkl. Kabel

Art.-Nr.: 950 050 302 001



Rücklichtglas li. (für bikelander)

Art.-Nr.: 950 050 302 003



Rücklichtglas re. (für bikelander)

Art.-Nr.: 950 050 302 004

Fahradträger Ersatzteile



Leuchenträger links (für BC 60, BC 70 & bikelander classic)

Art.-Nr.: 950 000 631 001



Leuchenträger rechts (für BC 60, BC 70 & bikelander classic)

Art.-Nr.: 950 000 631 002



Leuchenträger li. (für bikelander)

Art.-Nr.: 950 050 631 001



Leuchenträger re. (für bikelander)

Art.-Nr.: 950 050 631 002



Kennzeichenhalter (für bikelander/classic)

Art.-Nr.: 950 050 631 003



Kennzeichenklemmen (für bikelander/classic)

VPE. 2 Stck.

Art.-Nr.: 950 050 631 004



Kabelklammer für Kennzeichenhalter (für bikelander/classic)

VPE. 6 Stck.

Art.-Nr.: 950 050 642 001

Fahradträger Ersatzteile



Bügel (für bikelander/classic)

Art.-Nr.: 950 050 613 001



Bügelaufnahme (für BC 60, BC 70 & bikelander/classic)

inkl. 2x Zahnrad
(Auslaufmodell)

Art.-Nr.: 950 000 621 001



Sterngriff (für BC 60, BC 70 & bikelander/classic)

inkl. Flachrundschaube

Art.-Nr.: 950 000 637 001



Greifer kurz (für BC 60 & BC 70)

inkl. Schlüssel / Schloß

Art.-Nr.: 950 000 633 001



Greifer lang (für BC 60 & BC 70)

inkl. Schlüssel / Schloß

Art.-Nr.: 950 035 633 002



Greifer kurz (für bikelander/classic)

inkl. Schlüssel

Art.-Nr.: 950 050 633 006



Greifer lang (für bikelander/classic)

inkl. Schlüssel

Art.-Nr.: 950 050 633 007

Fahradträger Ersatzteile



Greifer für 3. Rad

inkl. Schlüssel / Schloß

Art.-Nr.: 950 001 633 004



Knebelmutter Greifer (2 Stck.) (für BC 70 & bikelander/classic)

inkl. 3 Schlüssel / Schloß
(für Model BC 60: Art.-Nr. 950 000 633 003)

Art.-Nr.: 950 035 633 003



Radauflage li. (für BC70 & bikelander/classic)

(für Model Portilo (- 12/11): Art.-Nr. 950 000 619 001)

Art.-Nr.: 950 050 619 002



Radauflage re. (für BC 70 & bikelander/classic)

(für Model Portilo (- 12/11): Art.-Nr. 950 000 619 001)

Art.-Nr.: 950 050 619 003



Federset für Radauflage

VPE 4 Stk.

Art.-Nr.: 950 050 626 001



Verriegelung Radauflage (für BC 60, BC 70 & bikelander/classic)

VPE 4 Stk.

Art.-Nr.: 950 010 627 001



Zahnriemen inkl. Verschuß (für BC 70 & bikelander/classic)

(für Model Portilo (- 12/11): Art.-Nr. 950 000 622 001)
(für Model BC 60: Art.-Nr. 950 010 622 001)

Art.-Nr.: 950 035 622 001

Fahradträger Ersatzteile



Felgenschoner (für BC 60, BC 70 & bikelander/classic)
VPE. 4 Stck.

Art.-Nr.: 950 030 622 001



Ersatzschlüssel (für BC 60, BC 70 & bikelander/classic)
VPE 2 Stck.
(xx = Schlüsselnummer)

Art.-Nr.: 950 000 513 3xx



Ersatzschlüssel (für Box & Plattform)
VPE 2 Stck.
(xx = Schlüsselnummer)

Art.-Nr.: 950 000 513 1xx



Ersatzschlösser für Transportbox
VPE 2 Stck.

Art.-Nr.: 950 002 513 300



Ersatzschloss für Transportplattform

Art.-Nr.: 950 004 513 300

Autocode

Autocode



Autocode

Codiergerät

- Zum Codieren des Fahrzeuges auf Anhängerbetrieb
- Inklusive unbegrenzte Anzahl an Freischaltungen im ersten Jahr als Abonnement

Art.-Nr.: 900 001 400 199



Autocode-Mini

Codiergerät

- Zum Codieren des Fahrzeuges auf Anhängerbetrieb
- Kein Abonnement notwendig: Kauf einer einzelnen Codierung oder wahlweise 5 bzw. 10 Codierungen zum Vorzugspreis.

Art.-Nr.: 900 001 400 202

Voucher Code Autocode-Mini für 1 Freischaltung

Art.-Nr.: 900 001 400 203

Voucher Code Autocode-Mini für 5 Freischaltungen

Art.-Nr.: 900 001 400 204

Voucher Code Autocode-Mini für 10 Freischaltungen

Art.-Nr.: 900 001 400 205

Jahresabonnement Autocode-Mini

Art.-Nr.: 900 001 400 208



Autocode-Remote

Codiergerät

- Zum Codieren des Fahrzeuges auf Anhängerbetrieb
- Kein Abonnement notwendig

Art.-Nr.: 900 001 400 209

Verstärkungsfedern

Programmübersicht Verstärkungsfedern

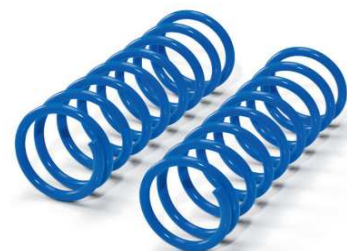

Stand: 11/2023

Marke	Modell	Baujahr	Artikelnummer	Gewicht (kg)	Einbauzeit (min)	Bemerkungen	Z = Zusatz- A = Austausch- Feder	Heav Duty für dauerhaft beladene Fzg.
Audi	A3 Cabrio (8V7,8VE)	10/2013- 10/2020	405403500001	1,5	45	auch für Quattro und e-tron nicht für Fahrzeuge mit Niveauregulierung nicht für S-Line Fahrwerk und S3	Z	
Audi	A3 Cabrio (8V7, 8VE)	10/2013- 10/2020	421676500001	2	45	auch für Quattro und e-tron nicht für Fahrzeuge mit Niveauregulierung nicht für S-Line Fahrwerk und S3	Z	HD
Audi	A3 Hatchback (8P1)	05/2003- 08/2012	421600500001	1,3	30	auch für Quattro nicht für Fahrzeuge mit Niveauregulierung	Z	
Audi	A3 Limousine (8VS, 8VM)	05/2013- 10/2020	405403500001	1,5	45	nicht für S-Line Fahrwerk, S3 und RS3 auch für Quattro und e-tron nicht für Fahrzeuge mit Niveauregulierung	Z	
Audi	A3 Limousine (8VS, 8VM)	05/2013- 10/2020	421676500001	2	45	auch für Quattro und e-tron nicht für Fahrzeuge mit Niveauregulierung Nicht für S-Line Fahrwerk, S3 und RS3	Z	HD
Audi	A3 Limousine (8YS)	04/2020-	405403500001	1,5	45	auch für Quattro und e-tron nicht für Fahrzeuge mit Niveauregulierung Nicht für S-Line Fahrwerk, S3 und RS3	Z	
Audi	A3 Limousine (8YS)	04/2020-	421676500001	2	45	auch für Quattro und e-tron nicht für Fahrzeuge mit Niveauregulierung Nicht für S-Line Fahrwerk, S3 und RS3	Z	HD
Audi	A3 Sportback (8PA)	05/2003- 03/2013	421600500001	1,3	30	auch für Quattro nicht für Fahrzeuge mit Niveauregulierung	Z	
Audi	A3 Sportback (8VA, 8VF)	09/2012- 10/2020	405403500001	1,5	45	auch für Quattro und e-tron nicht für Fahrzeuge mit Niveauregulierung Nicht für S-Line Fahrwerk, S3 und RS3	Z	

Marke	Modell	Baujahr	Artikelnummer	Gewicht (kg)	Einbauzeit (min)	Bemerkungen	Z = Zusatz- A = Austausch- Feder	Heav Duty für dauerhaft beladene Fzg.
Audi	A3 Sportback (8VA, 8VF)	09/2012- 10/2020	421676500001	2	45	auch für Quattro und e-tron nicht für Fahrzeuge mit Niveauregulierung Nicht für S-Line Fahrwerk, S3 und RS3	Z	HD
Audi	A3 Sportback (8YA)	11/2019-	405403500001	1,5	45	auch für Quattro und e-tron nicht für Fahrzeuge mit Niveauregulierung Nicht für S-Line Fahrwerk, S3 und RS3	Z	
Audi	A3 Sportback (8YA)	11/2019-	421676500001	2	45	auch für Quattro und e-tron nicht für Fahrzeuge mit Niveauregulierung Nicht für S-Line Fahrwerk, S3 und RS3	Z	HD
Audi	A3 (8V1, 8VK)	04/2012- 10/2020	405403500001	1,5	45	auch für Quattro und e-tron nicht für Fahrzeuge mit Niveauregulierung nicht für S-Line Fahrwerk, S3 und RS3	Z	
Audi	A3 (8V1, 8VK)	04/2012- 10/2020	421676500001	2	45	auch für Quattro und e-tron nicht für Fahrzeuge mit Niveauregulierung Nicht für S-Line Fahrwerk, S3 und RS3	Z	HD
Audi	A4 B8 Avant (8K5)	11/2007- 12/2015	405425500001	1,5	30	nicht für Fahrzeuge mit Niveauregulierung auch für Quattro nicht für S-Line Fahrwerk, S4 und RS4	Z	
Audi	A4 B8 Limousine (8K2)	11/2007- 12/2015	405425500001	1,5	30	nicht für Fahrzeuge mit Niveauregulierung auch für Quattro nicht für S-Line Fahrwerk, S4 und RS4	Z	
Audi	A5 B8 (8T3)	06/2007- 01/2017	405425500001	1,5	30	nicht für Fahrzeuge mit Niveauregulierung auch für Quattro nicht für S-Line Fahrwerk, S5 und RS5	Z	
Audi	A6 C7 Avant (4G5, 4GD)	05/2011- 09/2018	405425500001	1,5	30	nicht für Fahrzeuge mit Niveauregulierung auch für Quattro nicht für S-Line Fahrwerk, S6 und RS6	Z	
Audi	A6 C7 Limousine (4G2, 4GC)	11/2010- 09/2018	405425500001	1,5	30	nicht für Fahrzeuge mit Niveauregulierung auch für Quattro nicht für S-Line Fahrwerk, S6 und RS6	Z	
Audi	Q2 (GAB, GAG)	06/2016-	421676500001	2	45	auch für Quattro nicht für Fahrzeuge mit Niveauregulierung nicht für S-Line Fahrwerk und SQ2	Z	HD

Marke	Modell	Baujahr	Artikelnummer	Gewicht (kg)	Einbauzeit (min)	Bemerkungen	Z = Zusatz- A = Austausch- Feder	Heav Duty für dauerhaft beladene Fzg.
Audi	Q2 (GAB,GAG)	06/2016-	405403500001	1,5	45	auch für Quattro nicht für Fahrzeuge mit Niveauregulierung nicht für S-Line Fahrwerk und SQ2	Z	
Audi	Q3 Sportback (F3N)	09/2019-	405403500001	1,5	45	auch für Quattro nicht für Fahrzeuge mit Niveauregulierung nicht für S-Line Fahrwerk, SQ3 und RSQ3	Z	
Audi	Q3 Sportback (F3N)	09/2019-	421676500001	2	45	auch für Quattro nicht für Fahrzeuge mit Niveauregulierung nicht für S-Line Fahrwerk, SQ3 und RSQ3	Z	HD
Audi	Q3 (8UB, 8UG)	06/2011- 10/2018	421600500001	1,3	45	auch für Quattro nicht für Fahrzeuge mit Niveauregulierung nicht für S-Line Fahrwerk und RSQ3	Z	
Audi	Q3 (F3B)	08/2018-	405403500001	1,5	45	auch für Quattro nicht für Fahrzeuge mit Niveauregulierung nicht für S-Line Fahrwerk, SQ3 und RSQ3	Z	
Audi	Q3 (F3B)	08/2018-	421676500001	2	45	auch für Quattro nicht für Fahrzeuge mit Niveauregulierung nicht für S-Line Fahrwerk, SQ3 und RSQ3	Z	HD
Audi	Q5 (8RB)	11/2008- 05/2017	405425500001	1,5	30	auch für Quattro und Hybrid nicht für Fahrzeuge mit Niveauregulierung nicht für S-Line Fahrwerk und SQ5	Z	
Citroën	Berlingo L1 (B9)	04/2008- 08/2018	404092500001	6,7	30	für Fahrzeuge mit SWB (kurzer Radstand) nicht für Multispace	A	
Citroën	Berlingo L2 (B9)	04/2008- 08/2018	404131500001	7,1	30	auch für Facelift ab Baujahr 08/2016 für Fahrzeuge mit LWB (langer Radstand)	A	
Citroën	Berlingo M & XL (K9)	03/2018-	404131500001	7,1	30	für Fahrzeuge mit weißen PUR- Endanschlügen nur für Fahrzeuge mit Frontantrieb nicht für Fahrzeuge mit serienmäßiger Höherlegung, Luftfederung, lastabhängigem Bremsdruckregler an Achse 2 und Niveauregulierung	A	HD

Marke	Modell	Baujahr	Artikelnummer	Gewicht (kg)	Einbauzeit (min)	Bemerkungen	Z = Zusatz- A = Austausch- Feder	Heav Duty für dauerhaft beladene Fzg.
Citroën	Berlingo M (K9)	06/2018-	404092500001	6,7	30	für Fahrzeuge mit weißen PUR-Endanschlügen nur für Fahrzeuge mit Frontantrieb nicht für Fahrzeuge mit serienmäßiger Höherlegung, Luftfederung, lastabhängigem Bremsdruckregler an Achse 2 und Niveauregulierung	A	
Citroën	Berlingo Multispace (B9)	04/2008- 08/2018	404335500001	7	30	nicht für Fahrzeuge mit 4x4 (Allrad) und XTR	Z	
Citroën	C4 Grand Picasso II (DA, DE)	09/2013- 03/2018	404151500001	1,9	45	nicht für Hybrid und Fahrzeuge mit Niveauregulierung	Z	
Citroën	C4 Grand SpaceTourer (3A, 3E)	04/2018-	404151500001	1,9	45	nicht für Fahrzeuge mit Luftfahrwerk, lastabhängigem Bremsdruckregler an Achse 2 und Niveauregulierung	Z	
Citroën	C4 Picasso II	02/2013- 03/2018	404151500001	1,9	45	nicht für Hybrid und Fahrzeuge mit Niveauregulierung	Z	
Citroën	C4 Picasso (UD)	10/2006- 08/2013	404092500001	6,7	30	nicht für Fahrzeuge mit Luftfederung	A	
Citroën	C4 SpaceTourer (3D)	04/2018-	404151500001	1,9	45	nicht für Fahrzeuge mit Luftfahrwerk, lastabhängigem Bremsdruckregler an Achse 2 und Niveauregulierung	Z	
Citroën	Jumper II (250)	04/2006-	406374500001	8,4	45	auch für e-Jumper (Elektro und Hybrid) nur für Fahrzeuge mit Leergewichtsachslasten ab 1.100 kg die Mindestladung beträgt 350 kg nicht für AL-KO Hinterachse, Fzg. mit Niveauregulierung, serienmäßige Luftfederung & lastabhängigem Bremsdruckregler an Achse 2	Z	HD
Citroën	Jumper II (250)	04/2006-	404271500001	3,8	45	auch für e-Jumper (Elektro und Hybrid) nur für Fahrzeuge mit Einzel-Blattfedern nicht für Fahrzeuge mit lastabhängigen Bremsdruckreglern	Z	

Marke	Modell	Baujahr	Artikelnummer	Gewicht (kg)	Einbauzeit (min)	Bemerkungen	Z = Zusatz- A = Austausch- Feder	Heav Duty für dauerhaft beladene Fzg.
Citroën	Jumpy II Bus/Kasten (VF7)	01/2007-03/2016	404333500001	2,5	45	nicht für Fahrzeuge mit Niveauregulierung	Z	
Cupra	Formentor (KM7)	07/2020-	405403500001	1,5	45	auch für 4Drive nicht für Fahrzeuge mit Niveauregulierung	Z	
Cupra	Formentor (KM7)	07/2020-	421676500001	2	45	auch für 4Drive nicht für Fahrzeuge mit Niveauregulierung	Z	HD
Fiat	Doblo II Cargo (263)	02/2010-06/2022	406368500001	2,3	45	nicht für Kombi	Z	
Fiat	Doblo II Kombi (263)	11/2009-06/2022	406369500001	1,6	45	nicht für Kastenwagen und Pritsche	Z	
Fiat	Doblo II Pritsche (263)	02/2010-	406368500001	2,3	45		Z	
Fiat	Ducato (250)	07/2006-	404271500001	3,8	45	auch für E-Ducato (Elektro und Hybrid) nur für Fahrzeuge mit Einzel-Blattfedern nicht für Fahrzeuge mit lastabhängigen Bremsdruckreglern	Z	
Fiat	Ducato (250)	07/2006-	406374500001	8,4	45	nur für Fahrzeuge mit ABS und Leergewichtsachslasten ab 1.100 kg auch für E-Ducato (Elektro und Hybrid) die Mindestladung beträgt 350 kg nicht für AL-KO Hinterachse, Fahrzeuge mit Niveauregulierung, serienmäßige Luftfederung und lastabhängigem Bremsdruckregler an Achse 2	Z	HD
Fiat	Scudo (270, 272)	01/2007-03/2016	404333500001	2,5	45	nicht für Fahrzeuge mit Niveauregulierung	Z	
Fiat	Talento (296)	06/2016-	414364500001	2,3	45		Z	
Fiat	Talento (296)	06/2016-	414870500001	10,2	30		A	HD
Ford	Mondeo V Schrägheck (CE)	02/2015-	407527500001	1,2	30	auch für Hybrid	Z	

Marke	Modell	Baujahr	Artikelnummer	Gewicht (kg)	Einbauzeit (min)	Bemerkungen	Z = Zusatz- A = Austausch- Feder	Heav Duty für dauerhaft beladene Fzg.
Ford	Mondeo V Stufenheck (CD)	02/2015-	407527500001	1,2	30	auch für Hybrid	Z	
Ford	Mondeo V Turnier (CF)	02/2015-	407527500001	1,2	30	auch für Hybrid	Z	
Ford	Transit Connect II (V408)	02/2013- 09/2018	407526500001	11,1	30	für L1 & L2 Heavy Duty Satz bei L1	A	HD
Ford	Tourneo Connect III	02/2022-	421678500001	7	30	nicht für Fzg. mit Tieferlegung, Luftfahrwerk, lastabhängigem Bremsdruckregler an Achse 2 und Niveauregulierung	A	
Ford	Transit Connect III	05/2022-	421678500001	7	30	nicht für Fzg. mit Tieferlegung, Luftfahrwerk, lastabhängigem Bremsdruckregler an Achse 2 und Niveauregulierung	A	
Ford	Transit VII V363 Bus/Kasten (FAD, FBD, FCD, FDD)	08/2013-	407530500001	9	30	nur für Fahrzeuge mit Frontantrieb	Z	
Ford	Transit VII V363 Pritsche (FED, FFD)	08/2013-	407530500001	9	30	nur für Fahrzeuge mit Frontantrieb	Z	
Hyundai	I30 CW (FD)	10/2007- 06/2012	446075500001	5,3	60	nicht für Fahrzeuge mit Niveauregulierung	A	
Hyundai	I30 CW (GD)	06/2012- 06/2017	446075500001	5,3	60	nicht für Fahrzeuge mit Niveauregulierung	A	
Hyundai	iX35 (LM, EL, ELH)	08/2009- 09/2015	446075500001	5,3	60	nur für Fahrzeuge mit Frontantrieb nicht für Fahrzeuge mit Niveauregulierung	A	
Hyundai	Tucson (TL, TLE)	06/2015- 09/2020	446073500001	4,6	45	auch für Allrad nicht für Fahrzeuge mit Niveauregulierung	Z	
Kia	Cee´d SW (ED)	07/2007- 12/2012	446075500001	5,3	60	nicht für Fahrzeuge mit lastabhängigen Bremsdruckreglern und Niveauregulierung	A	
Kia	Cee´d SW (JD)	09/2012- 07/2018	446075500001	5,3	60	nicht für Fahrzeuge mit lastabhängigen Bremsdruckreglern und Niveauregulierung	A	

Marke	Modell	Baujahr	Artikelnummer	Gewicht (kg)	Einbauzeit (min)	Bemerkungen	Z = Zusatz- A = Austausch- Feder	Heav Duty für dauerhaft beladene Fzg.
Kia	Sportage III (SL)	06/2010-02/2016	446075500001	5,3	60	nur für Fahrzeuge mit Frontantrieb nicht für Fahrzeuge mit Niveauregulierung	A	
Kia	Sportage IV (QL, QLE)	09/2015-09/2022	446073500001	4,6	45	auch für Allrad nicht für Fahrzeuge mit Niveauregulierung	Z	
Mercedes Benz	Citan Kasten (W415)	11/2012-08/2021	413432500001	1,6	45	nicht für Fahrzeuge mit Niveauregulierung	Z	
Mercedes Benz	Citan Tourer (W415)	11/2012-08/2021	413432500001	1,6	45	nicht für Fahrzeuge mit Niveauregulierung	Z	
Mercedes Benz	EQV (W447)	06/2020-	413435500001	11,2	30	nicht für Fahrzeuge mit Niveauregulierung und Höherlegung	A	
Mercedes Benz	EQV (W447)	06/2020-	413436500001	11,2	30	die Mindestladung muss immer 150 kg betragen nicht für Fahrzeuge mit Niveauregulierung und Höherlegung	A	HD
Mercedes Benz	Sprinter (906)	06/2006-01/2018	413376500001	10,9	60	nur für Fahrzeuge mit Einzelbereifung auch für Fahrzeuge mit Original Tieferlegung nicht für 4x4	Z	
Mercedes Benz	Sprinter (907)	02/2018-	413376500001	10,9	45	nur für Fahrzeuge mit Heckantrieb und Einzelbereifung nicht für Fahrzeuge serienmäßiger Luftfederung, CE8 erhöhte Fahrzeuge, lastabhängigen Bremsdruckregler und Niveauregulierung	Z	
Mercedes Benz	Viano (W639)	09/2003-10/2014	413382500001	2,7	45	nur für Fahrzeuge mit ABS nicht für Fahrzeuge mit Niveauregulierung	Z	
Mercedes Benz	Vito (W639)	09/2003-10/2014	413382500001	2,7	45	nur für Fahrzeuge mit ABS nicht für Fahrzeuge mit Niveauregulierung	Z	
Mercedes Benz	Vito (W447)	03/2014-	413435500001	11,2	30	auch für 4Matic und eVito nicht für Fahrzeuge mit Niveauregulierung und Höherlegung	A	
Mercedes Benz	Vito Tourer (W447)	03/2014-	413435500001	11,2	30	auch für 4Matic und eVito nicht für Fahrzeuge mit Niveauregulierung und Höherlegung	A	

Marke	Modell	Baujahr	Artikelnummer	Gewicht (kg)	Einbauzeit (min)	Bemerkungen	Z = Zusatz- A = Austausch- Feder	Heav Duty für dauerhaft beladene Fzg.
Mercedes Benz	Vito Tourer (W447)	03/2014-	413436500001	11,2	30	die Mindestladung muss immer 150 kg betragen auch für 4Matic und eVito nicht für Fahrzeuge mit Niveauregulierung und Höherlegung	A	HD
Mercedes Benz	Vito (W447)	03/2014-	413436500001	11,2	30	die Mindestladung muss immer 150 kg betragen auch für 4Matic und eVito nicht für Fahrzeuge mit Niveauregulierung und Höherlegung	A	HD
Mercedes Benz	V-Klasse (W447)	03/2014-	413435500001	11,2	30	auch für 4Matic nicht für Fahrzeuge mit Niveauregulierung und Höherlegung	A	
Mercedes Benz	V-Klasse (W447)	03/2014-	413436500001	11,2	30	die Mindestladung muss immer 150 kg betragen auch für 4Matic nicht für Fahrzeuge mit Niveauregulierung und Höherlegung	A	HD
Nissan	NV300 (X82)	09/2016-	414364500001	2,3	45		Z	
Nissan	NV300 (X82)	09/2016-	414870500001	10,2	30		A	HD
Nissan	NV400 (X62, X62B)	11/2011-	416318500001	8,1	30	nur für Fahrzeuge mit Frontantrieb und Einzelblattfedern	Z	
Nissan	Primastar (X83)	03/2001- 08/2016	414364500001	2,3	45	nur für Fahrzeuge mit 16" Serienbereifung bis max. 1.650 kg Achslast hinten bei Fahrzeugen mit ALB-Regler	Z	
Nissan	Primastar (X83)	03/2001- 08/2016	414870500001	10,2	30	nur für Fahrzeuge mit ABS	A	HD

Marke	Modell	Baujahr	Artikelnummer	Gewicht (kg)	Einbauzeit (min)	Bemerkungen	Z = Zusatz- A = Austausch- Feder	Heav Duty für dauerhaft beladene Fzg.
Opel	Combo Cargo M (K9)	06/2018-	404092500001	6,7	30	nicht für Tour / Life für Fahrzeuge mit weißen PUR- Endanschlügen nur für Fahrzeuge mit Frontantrieb nicht für Fahrzeuge mit serienmäßiger Höherlegung, Luftfederung, lastabhängigem Bremsdruckregler an Achse 2 und Niveauregulierung	A	
Opel	Combo Kasten (X12)	02/2012- 08/2018	406368500001	2,3	45	nicht für Tour	Z	
Opel	Combo Tour / Life M & XL (K9)	06/2018-	404131500001	7,1	30	für Fahrzeuge mit weißen PUR- Endanschlügen nur für Fahrzeuge mit Frontantrieb nicht für Fahrzeuge mit serienmäßiger Höherlegung, Luftfederung, lastabhängigem Bremsdruckregler an Achse 2 und Niveauregulierung	A	HD
Opel	Combo Tour (X12)	02/2012- 08/2018	406369500001	1,6	45	nicht für Kastenwagen und Kombi	Z	
Opel	Movano B (X62)	05/2010- 10/2021	416318500001	8,1	30	nur für Fahrzeuge mit Frontantrieb und Einzelblattfedern	Z	
Opel	Movano C (U9)	12/2021-	404271500001	3,8	45	auch für Movano-e (Elektro und Hybrid) nur für Fahrzeuge mit Einzel-Blattfedern nicht für Fahrzeuge mit lastabhängigen Bremsdruckreglern	Z	
Opel	Movano C (U9)	12/2021-	406374500001	8,4	45	nur für Fahrzeuge mit Leergewichtsachslasten ab 1.100 kg auch für Movano-e (Elektro und Hybrid) die Mindestladung beträgt 350 kg nicht für AL-KO Hinterachse, Fahrzeuge mit Niveauregulierung, serienmäßige Luftfederung und lastabhängigem Bremsdruckregler an Achse 2	Z	HD

Marke	Modell	Baujahr	Artikelnummer	Gewicht (kg)	Einbauzeit (min)	Bemerkungen	Z = Zusatz- A = Austausch- Feder	Heav Duty für dauerhaft beladene Fzg.
Opel	Vivaro A (X83)	08/2001-07/2014	414364500001	2,3	45	bis max. 1.650 kg Achslast hinten bei Fahrzeugen mit ALB-Regler	Z	
Opel	Vivaro A (X83)	08/2001-07/2014	414870500001	10,2	30	nur für Fahrzeuge mit ABS	A	HD
Opel	Vivaro B (X82)	06/2014-12/2019	414364500001	2,3	45		Z	
Opel	Vivaro B (X82)	06/2014-12/2019	414870500001	10,2	30		A	HD
Peugeot	3008 II (M_)	05/2016-	404151500001	1,9	45	nicht für Hybrid und Fahrzeuge mit Niveauregulierung	Z	
Peugeot	308 II SW (L_)	09/2013-06/2021	404151500001	1,9	45		Z	
Peugeot	308 II (L_)	09/2013-06/2021	404151500001	1,9	45		Z	
Peugeot	5008 II (M_)	06/2017-	404151500001	1,9	45	nicht für Fahrzeuge mit Niveauregulierung	Z	
Peugeot	Boxer	09/2005-	406374500001	8,4	45	auch für E-Boxer (Elektro und Hybrid) nur für Fahrzeuge mit Leergewichtsachslasten ab 1.100 kg die Mindestladung beträgt 350 kg nicht für AL-KO Hinterachse, Fahrzeuge mit Niveauregulierung, serienmäßige Luftfederung und lastabhängigem Bremsdruckregler an Achse 2	Z	HD
Peugeot	Boxer	09/2005-	404271500001	3,8	45	auch für E-Boxer (Elektro und Hybrid) nur für Fahrzeuge mit Einzel-Blattfedern nicht für Fahrzeuge mit lastabhängigen Bremsdruckreglern	Z	
Peugeot	Expert (VF3)	01/2007-03/2016	404333500001	2,5	45	nicht für Fahrzeuge mit Niveauregulierung	Z	
Peugeot	Partner Kasten L1	04/2008-08/2018	404092500001	6,7	30	für Fahrzeuge mit SWB (kurzer Radstand) nicht für Tepee	A	

Marke	Modell	Baujahr	Artikelnummer	Gewicht (kg)	Einbauzeit (min)	Bemerkungen	Z = Zusatz- A = Austausch- Feder	Heav Duty für dauerhaft beladene Fzg.
Peugeot	Partner Kasten L1 (K9)	09/2018-	404092500001	6,7	30	für Fahrzeuge mit SWB (kurzer Radstand) für Fahrzeuge mit weißen PUR-Endanschlügen nur für Fahrzeuge mit Frontantrieb nicht für Fahrzeuge mit serienmäßiger Höherlegung, Luftfederung, lastabhängigem Bremsdruckregler an Achse 2 und Niveauregulierung	A	
Peugeot	Partner L2	04/2008- 08/2018	404131500001	7,1	30	für Fahrzeuge mit LWB (langer Radstand)	A	
Peugeot	Partner Tepee	06/2008-	404335500001	7	30	nicht für Outdoor, XTR und Fahrzeuge mit Niveauregulierung	Z	
Peugeot	Rifter L1 & L2	09/2018-	404131500001	7,1	30	für Fahrzeuge mit weißen PUR-Endanschlügen nicht für Fahrzeuge mit serienmäßiger Höherlegung, Luftfahrwerk, lastabhängigem Bremsdruckregler an Achse 2 und Niveauregulierung	A	HD
Renault	Master III (JV, FV)	02/2010-	416318500001	8,1	30	auch für Z.E. nur für Fahrzeuge mit Frontantrieb und Einzelblattfedern	Z	
Renault	Trafic II (JL, FL)	03/2001- 04/2014	414870500001	10,2	30		A	HD
Renault	Trafic II (JL, FL)	03/2001- 07/2014	414364500001	2,3	45	bis max. 1.650 kg Achslast hinten bei Fahrzeugen mit ALB-Regler	Z	
Renault	Trafic III (FG, JG)	05/2014-	414364500001	2,3	45		Z	
Renault	Trafic III (JG, FG)	05/2014-	414870500001	10,2	30		A	HD
Seat	Alhambra (7N, 710, 711)	06/2010-	421600500001	1,3	30	auch für Ecomotive nicht für Fahrzeuge mit Niveauregulierung	Z	
Seat	Altea XL (5P5, 5P8)	03/2004- 12/2015	421600500001	1,3	30	auch für Ecomotive nicht für Fahrzeuge mit Niveauregulierung	Z	

Marke	Modell	Baujahr	Artikelnummer	Gewicht (kg)	Einbauzeit (min)	Bemerkungen	Z = Zusatz- A = Austausch- Feder	Heav Duty für dauerhaft beladene Fzg.
Seat	Altea (5P1)	03/2004- 12/2015	421600500001	1,3	30	auch für Ecomotive nicht für Fahrzeuge mit Niveauregulierung	Z	
Seat	Ateca (KH7, KHP)	04/2016-	405403500001	1,5	45	auch für 4Drive für Fahrzeuge mit Multilink-Achse nicht für Fahrzeuge mit Niveauregulierung nicht für Cupra Ateca	Z	
Seat	Ateca (KH7, KHP)	04/2016-	421676500001	2	45	auch für 4Drive für Fahrzeuge mit Multilink-Achse nicht für Fahrzeuge mit Niveauregulierung nicht für Cupra Ateca	Z	HD
Seat	Leon II (1P1)	05/2005- 12/2012	421600500001	1,3	30	auch für Ecomotive nicht für Fahrzeuge mit Niveauregulierung	Z	
Seat	Leon III Hatchback (5F1)	09/2012- 08/2020	421676500001	2	45	auch für 4Drive nicht für Fahrzeuge mit Luftfahrwerk, lastabhängigem Bremsdruckregler an Achse 2 und Niveauregulierung nicht für Cupra	Z	HD
Seat	Leon III Hatchback (5F1)	09/2012- 08/2020	405403500001	1,5	45	auch für 4Drive nicht für Fahrzeuge mit Luftfahrwerk, lastabhängigem Bremsdruckregler an Achse 2 und Niveauregulierung nicht für Cupra	Z	
Seat	Leon III SC (5F5)	01/2013- 08/2018	405403500001	1,5	45	auch für 4Drive nicht für Fahrzeuge mit Luftfahrwerk, lastabhängigem Bremsdruckregler an Achse 2 und Niveauregulierung nicht für Cupra	Z	
Seat	Leon III SC (5F5)	01/2013- 08/2018	421676500001	2	45	auch für 4Drive nicht für Fahrzeuge mit Luftfahrwerk, lastabhängigem Bremsdruckregler an Achse 2 und Niveauregulierung nicht für Cupra	Z	HD

Marke	Modell	Baujahr	Artikelnummer	Gewicht (kg)	Einbauzeit (min)	Bemerkungen	Z = Zusatz- A = Austausch- Feder	Heav Duty für dauerhaft beladene Fzg.
Seat	Leon III Sportstourer (5F8)	09/2012-08/2020	405403500001	1,5	45	auch für 4Drive nicht für Fahrzeuge mit Luftfahrwerk, lastabhängigem Bremsdruckregler an Achse 2 und Niveauregulierung nicht für Cupra	Z	
Seat	Leon III Sportstourer (5F8)	09/2012-08/2020	421676500001	2	45	auch für 4Drive nicht für Fahrzeuge mit Luftfahrwerk, lastabhängigem Bremsdruckregler an Achse 2 und Niveauregulierung nicht für Cupra	Z	HD
Seat	Leon III X-Perience (5F8)	09/2012-08/2020	405403500001	1,5	45	auch für 4Drive nicht für Fahrzeuge mit Luftfahrwerk, lastabhängigem Bremsdruckregler an Achse 2 und Niveauregulierung	Z	
Seat	Leon III X-Perience (5F8)	09/2012-08/2020	421676500001	2	45	auch für 4Drive nicht für Fahrzeuge mit Luftfahrwerk, lastabhängigem Bremsdruckregler an Achse 2 und Niveauregulierung	Z	HD
Seat	Leon IV Hatchback (KL1)	11/2019-	405403500001	1,5	45	auch für 4Drive nicht für Fahrzeuge mit Luftfahrwerk, lastabhängigem Bremsdruckregler an Achse 2 und Niveauregulierung nicht für Cupra	Z	
Seat	Leon IV Hatchback (KL1)	11/2019-	421676500001	2	45	auch für 4Drive nicht für Fahrzeuge mit Luftfahrwerk, lastabhängigem Bremsdruckregler an Achse 2 und Niveauregulierung nicht für Cupra	Z	HD
Seat	Leon IV Sportstourer (KL8)	03/2020-	405403500001	1,5	45	auch für 4Drive nicht für Fahrzeuge mit Luftfahrwerk, lastabhängigem Bremsdruckregler an Achse 2 und Niveauregulierung nicht für Cupra	Z	

Marke	Modell	Baujahr	Artikelnummer	Gewicht (kg)	Einbauzeit (min)	Bemerkungen	Z = Zusatz- A = Austausch- Feder	Heav Duty für dauerhaft beladene Fzg.
Seat	Leon IV Sportstourer (KL8)	03/2020-	421676500001	2	45	auch für 4Drive nicht für Fahrzeuge mit Luftfahrwerk, lastabhängigem Bremsdruckregler an Achse 2 und Niveauregulierung nicht für Cupra	Z	HD
Seat	Tarraco (KN2)	09/2018-	405403500001	1,5	45	für Fahrzeuge mit Multilink-Achse auch für 4Drive nicht für Fahrzeuge mit Niveauregulierung	Z	
Seat	Tarraco (KN2)	09/2018-	421676500001	2	45	für Fahrzeuge mit Multilink-Achse auch für 4Drive nicht für Fzg. mit Niveauregulierung	Z	HD
Seat	Toledo III (5P2)	04/2004- 05/2009	421600500001	1,3	30	auch für Ecomotive nicht für Fahrzeuge mit Niveauregulierung	Z	
Skoda	Karoq Scout (NU7, ND7)	07/2017-	405403500001	1,5	60	für Fahrzeuge mit Multilink-Achse auch für 4x4 nicht für Fahrzeuge mit Niveauregulierung	Z	
Skoda	Karoq Scout (NU7, ND7)	07/2017-	421676500001	2	45	für Fahrzeuge mit Multilink-Achse auch für 4x4 nicht für Fahrzeuge mit Niveauregulierung	Z	HD
Skoda	Karoq (NU7, ND7)	07/2017-	405403500001	1,5	60	auch für 4x4 für Fahrzeuge mit Multilink-Achse nicht für Fahrzeuge mit Niveauregulierung nicht für Sportsline	Z	
Skoda	Karoq (NU7, ND7)	07/2017-	421676500001	2	45	auch für 4x4 für Fahrzeuge mit Multilink-Achse nicht für Fahrzeuge mit Niveauregulierung nicht für Sportsline	Z	HD
Skoda	Kodiaq Scout (NS7, NV7, NS6)	10/2016-	405403500001	1,5	45	auch für 4x4 nicht für Fahrzeuge mit Niveauregulierung	Z	
Skoda	Kodiaq Scout (NS7, NV7, NS6)	10/2016-	421676500001	2	45	auch für 4x4 nicht für Fahrzeuge mit Niveauregulierung	Z	HD
Skoda	Kodiaq (NS7, NV7, NS6)	10/2016-	405403500001	1,5	45	auch für 4x4 nicht für Fahrzeuge mit Niveauregulierung nicht für Sportsline und RS	Z	

Marke	Modell	Baujahr	Artikelnummer	Gewicht (kg)	Einbauzeit (min)	Bemerkungen	Z = Zusatz- A = Austausch- Feder	Heav Duty für dauerhaft beladene Fzg.
Skoda	Kodiaq (NS7, NV7, NS6)	10/2016-	421676500001	2	45	auch für 4x4 nicht für Fahrzeuge mit Niveauregulierung nicht für Sportsline und RS	Z	HD
Skoda	Octavia II Combi (1Z5)	02/2004- 06/2013	421600500001	1,3	30	auch für 4x4 und Greenline nicht für Niveauregulierung	Z	
Skoda	Octavia II Limousine (1Z3)	02/2004- 06/2013	421600500001	1,3	30	auch für 4x4 und Greenline nicht für Niveauregulierung	Z	
Skoda	Octavia II Scout (1Z5)	02/2004- 06/2013	421600500001	1,3	30	auch für 4x4 und Greenline nicht für Niveauregulierung	Z	
Skoda	Octavia III Combi (5E5, 5E6)	11/2012- 10/2020	405403500001	1,5	45	auch für 4x4 nicht für Fahrzeuge mit Luftfahrwerk, lastabhängigem Bremsdruckregler an Achse 2 und Niveauregulierung nicht für RS und Sportsline	Z	
Skoda	Octavia III Combi (5E5, 5E6)	11/2012- 10/2020	421676500001	2	45	auch für 4x4 nicht für Fahrzeuge mit Luftfahrwerk, lastabhängigem Bremsdruckregler an Achse 2 und Niveauregulierung nicht für RS und Sportsline	Z	HD
Skoda	Octavia III Limousine (5E3, NL3, NR3)	11/2012- 10/2020	405403500001	1,5	45	auch für 4x4 nicht für Fahrzeuge mit Luftfahrwerk, lastabhängigem Bremsdruckregler an Achse 2 und Niveauregulierung nicht für RS und Sportsline	Z	
Skoda	Octavia III Limousine (5E3, NL3, NR3)	11/2012- 10/2020	421676500001	2	45	auch für 4x4 nicht für Fahrzeuge mit Luftfahrwerk, lastabhängigem Bremsdruckregler an Achse 2 und Niveauregulierung nicht für RS und Sportsline	Z	HD
Skoda	Octavia III Scout (5E5, 5E6)	11/2012- 10/2020	405403500001	1,5	45	auch für 4x4 nicht für Fahrzeuge mit Luftfahrwerk, lastabhängigem Bremsdruckregler an Achse 2 und Niveauregulierung	Z	

Marke	Modell	Baujahr	Artikelnummer	Gewicht (kg)	Einbauzeit (min)	Bemerkungen	Z = Zusatz- A = Austausch- Feder	Heav Duty für dauerhaft beladene Fzg.
Skoda	Octavia III Scout (5E5, 5E6)	11/2012- 10/2020	421676500001	2	45	auch für 4x4 nicht für Fahrzeuge mit Luftfahrwerk, lastabhängigem Bremsdruckregler an Achse 2 und Niveauregulierung	Z	HD
Skoda	Octavia IV Combi (NX5)	11/2019-	405403500001	1,5	45	auch für 4x4 nicht für Fahrzeuge mit Luftfahrwerk, lastabhängigem Bremsdruckregler an Achse 2 und Niveauregulierung nicht für RS und Sportsline	Z	
Skoda	Octavia IV Combi (NX5)	11/2019-	421676500001	2	45	auch für 4x4 nicht für Fahrzeuge mit Luftfahrwerk, lastabhängigem Bremsdruckregler an Achse 2 und Niveauregulierung nicht für RS und Sportsline	Z	HD
Skoda	Octavia IV Limousine (NX3, NN3)	01/2020-	405403500001	1,5	45	auch für 4x4 nicht für Fahrzeuge mit Luftfahrwerk, lastabhängigem Bremsdruckregler an Achse 2 und Niveauregulierung nicht für RS und Sportsline	Z	
Skoda	Octavia IV Limousine (NX3, NN3)	01/2020-	421676500001	2	45	auch für 4x4 nicht für Fahrzeuge mit Luftfahrwerk, lastabhängigem Bremsdruckregler an Achse 2 und Niveauregulierung nicht für RS und Sportsline	Z	HD
Skoda	Octavia IV Scout (NX5)	11/2019-	405403500001	1,5	45	auch für 4x4 nicht für Fahrzeuge mit Luftfahrwerk, lastabhängigem Bremsdruckregler an Achse 2 und Niveauregulierung	Z	
Skoda	Octavia IV Scout (NX5)	11/2019-	421676500001	2	45	auch für 4x4 nicht für Fahrzeuge mit Luftfahrwerk, lastabhängigem Bremsdruckregler an Achse 2 und Niveauregulierung	Z	HD
Skoda	Superb II Combi (3T5)	10/2009- 05/2015	421600500001	1,3	30	auch für 4x4 und Greenline nicht für Fahrzeuge mit Niveauregulierung	Z	

Marke	Modell	Baujahr	Artikelnummer	Gewicht (kg)	Einbauzeit (min)	Bemerkungen	Z = Zusatz- A = Austausch- Feder	Heav Duty für dauerhaft beladene Fzg.
Skoda	Superb II Limousine (3T4)	03/2008-05/2015	421600500001	1,3	30	auch für 4x4 und Greenline nicht für Fahrzeuge mit Niveauregulierung	Z	
Skoda	Superb III Combi (3V5)	03/2015-	421676500001	2	45	auch für 4x4 nicht für Fahrzeuge mit Niveauregulierung nicht für Sportsline	Z	HD
Skoda	Superb III Kombi (3V5)	03/2015-	405403500001	1,5	45	auch für 4x4 nicht für Fahrzeuge mit Niveauregulierung nicht für Sportsline	Z	
Skoda	Superb III Limousine (3V3)	03/2015-	421676500001	2	45	auch für 4x4 nicht für Fahrzeuge mit Niveauregulierung nicht für Sportsline	Z	HD
Skoda	Superb III Limousine (3V3)	03/2015-	405403500001	1,5	45	auch für 4x4 nicht für Fahrzeuge mit Niveauregulierung nicht für Sportsline	Z	
Skoda	Superb III Scout (3V5)	03/2015-	405403500001	1,5	45	auch für 4x4 nicht für Fahrzeuge mit Niveauregulierung	Z	
Skoda	Superb III Scout (3V5)	03/2015-	421676500001	2	45	auch für 4x4 nicht für Fahrzeuge mit Niveauregulierung	Z	HD
Skoda	Yeti (5L)	05/2009-12/2017	421600500001	1,3	30	auch für 4x4 und Greenline nicht für Fahrzeuge mit Niveauregulierung	Z	
Suzuki	SX4 S-Cross (JY)	08/2013-12/2021	441001500001	1,5	45	auch für Allrad nicht für Fahrzeuge mit Niveauregulierung	Z	
Suzuki	Vitara (LY)	03/2015-	441001500001	1,5	45	auch für Allrad nicht für Fahrzeuge mit Niveauregulierung	Z	
Toyota	Auris Touring Sports (E18)	10/2012-12/2018	435003500001	1,4	45	auch für Hybrid nicht für 1.3 Benziner, 1.4 Diesel und 1.6 Diesel nicht für Fahrzeuge mit Niveauregulierung	Z	
Toyota	Auris (E18)	10/2012-12/2018	435003500001	1,4	45	auch für Hybrid nicht für 1.3 Benziner, 1.4 Diesel und 1.6 Diesel nicht für Fahrzeuge mit Niveauregulierung	Z	
Toyota	Avensis Station Wagon (T27)	02/2009-10/2018	435003500001	1,4	45	nicht für Fahrzeuge mit Niveauregulierung	Z	

Marke	Modell	Baujahr	Artikelnummer	Gewicht (kg)	Einbauzeit (min)	Bemerkungen	Z = Zusatz- A = Austausch- Feder	Heav Duty für dauerhaft beladene Fzg.
Toyota	Avensis (T27)	02/2009-10/2018	435003500001	1,4	45	nicht für Fahrzeuge mit Niveauregulierung	Z	
Toyota	Proace City L1	10/2019-	404092500001	6,7	30	für Fahrzeuge mit weißen PUR-Endanschlägen nur für Fahrzeuge mit Frontantrieb nicht für Fahrzeuge mit serienmäßiger Höherlegung, Luftfederung, lastabhängigem Bremsdruckregler an Achse 2 und Niveauregulierung	A	
Toyota	Proace City L1 & L2	10/2019-	404131500001	7,1	30	für Fahrzeuge mit weißen PUR-Endanschlägen nur für Fahrzeuge mit Frontantrieb nicht für Fahrzeuge mit serienmäßiger Höherlegung, Luftfederung, lastabhängigem Bremsdruckregler an Achse 2 und Niveauregulierung	A	HD
Toyota	Proace (MDX)	06/2013-03/2016	404333500001	2,5	45	nicht für Fahrzeuge mit Niveauregulierung	Z	
VW	Arteon (3H7)	03/2017-	405403500001	1,5	60	auch für 4motion nicht für Fahrzeuge mit Niveauregulierung nicht für Arteon R	Z	
VW	Arteon (3H7, 3H8)	04/2017-	421676500001	2	45	nicht für Fahrzeuge mit Niveauregulierung nicht für Arteon R	Z	HD
VW	Beetle Cabrio (5C7, 5C8)	04/2011-07/2019	421600500001	1,3	30	nur für Fahrzeuge mit Multilink-Achse nicht für Fahrzeuge mit Niveauregulierung	Z	
VW	Beetle (5C1 5C2)	04/2011-07/2019	421600500001	1,3	30	nur für Fahrzeuge mit Multilink-Achse nicht für Fahrzeuge mit Niveauregulierung	Z	
VW	Caddy III Kasten (2K_, 2C_)	03/2004-05/2015	421673500001	3,6	30	auch für Maxi, Doppelblattfedern, EcoFuel, 4motion nicht für Life und Fahrzeuge mit lastabhängigen Bremsdruckregler an Achse 2	Z	

Marke	Modell	Baujahr	Artikelnummer	Gewicht (kg)	Einbauzeit (min)	Bemerkungen	Z = Zusatz- A = Austausch- Feder	Heav Duty für dauerhaft beladene Fzg.
VW	Caddy IV Kasten (SA_)	06/2015- 09/2020	421673500001	3,6	30	auch für Maxi, Doppelblattfedern, EcoFuel, 4motion nicht für Life und Fahrzeuge mit lastabhängigen Bremsdruckregler an Achse 2	Z	
VW	Caddy V SBB, SB7	09/2020-	42678500001	7	30	nicht für Fzg. mit Tieferlegung, Luftfahrwerk, lastabhängigem Bremsdruckregler an Achse 2 und Niveauregulierung	A	
VW	Crafter (2E/2F)	04/2006- 12/2016	413376500001	10,9	60	nur für Fahrzeuge mit Einzelbereifung nicht für Fahrzeuge mit 4motion	Z	
VW	Eos (1F7, 1F8)	03/2006- 08/2015	421600500001	1,3	30	auch für Bluemotion nicht für Fahrzeuge mit Niveauregulierung	Z	
VW	Golf Plus (5M1, 521)	01/2005- 12/2013	421600500001	1,3	30	auch für 4motion und Bluemotion nicht für Fahrzeuge mit Niveauregulierung	Z	
VW	Golf Sportsvan VII (AM1, AN1)	02/2014- 08/2020	405403500001	1,5	45	nicht für Fahrzeuge mit Niveauregulierung	Z	
VW	Golf Sportsvan VII (AM1, AN1)	02/2014- 08/2020	421676500001	2	45	nicht für Fahrzeuge mit Niveauregulierung	Z	HD
VW	Golf V Hatchback (1K1)	10/2003- 02/2009	421600500001	1,3	30	auch für 4motion und Bluemotion nicht für Fahrzeuge mit Niveauregulierung nicht für GTI und Golf R32	Z	
VW	Golf V Variant (1K5)	06/2007- 07/2009	421600500001	1,3	30	auch für 4motion und Bluemotion nicht für Fahrzeuge mit Niveauregulierung	Z	
VW	Golf VI Variant (AJ5)	07/2009- 07/2013	421600500001	1,3	30	auch für 4motion und Bluemotion nicht für Fahrzeuge mit Niveauregulierung	Z	
VW	Golf VI (5K1)	10/2008- 11/2013	421600500001	1,3	30	auch für 4motion und Bluemotion nicht für Fahrzeuge mit Niveauregulierung nicht für GTI und Golf R	Z	
VW	Golf VII Alltrack (BA5, BV5)	04/2013- 08/2020	405403500001	1,5	45	auch für 4motion nicht für Fahrzeuge mit Niveauregulierung	Z	
VW	Golf VII Alltrack (BA5, BV5)	04/2013- 08/2020	421676500001	2	45	auch für 4motion nicht für Fahrzeuge mit Niveauregulierung	Z	HD

Marke	Modell	Baujahr	Artikelnummer	Gewicht (kg)	Einbauzeit (min)	Bemerkungen	Z = Zusatz- A = Austausch- Feder	Heav Duty für dauerhaft beladene Fzg.
VW	Golf VII Hatchback (5G1, BQ1, BE1, BE2)	08/2012- 08/2020	405403500001	1,5	45	auch für 4motion nicht für GTI und Golf R nicht für Fahrzeuge mit Niveauregulierung	Z	
VW	Golf VII Hatchback (5G1, BQ1, BE1, BE2)	08/2012- 08/2020	421676500001	2	45	auch für 4motion nicht für GTI und Golf R nicht für Fahrzeuge mit Niveauregulierung	Z	HD
VW	Golf VII Variant (BA5, BV5)	04/2013- 08/2020	405403500001	1,5	45	auch für 4motion nicht für Fahrzeuge mit Niveauregulierung nicht für Golf R	Z	
VW	Golf VII Variant (BA5, BV5)	04/2013- 08/2020	421676500001	2	45	auch für 4motion nicht für Fahrzeuge mit Niveauregulierung nicht für Golf R	Z	HD
VW	Golf VIII Alltrack (CG5)	08/2020-	405403500001	1,5	45	auch für 4motion nicht für Fahrzeuge mit Niveauregulierung	Z	
VW	Golf VIII Alltrack (CG5)	08/2020-	421676500001	2	45	auch für 4motion nicht für Fahrzeuge mit Niveauregulierung	Z	HD
VW	Golf VIII Hatchback (CD1)	07/2019-	405403500001	1,5	45	auch für 4motion nicht für Fahrzeuge mit Niveauregulierung nicht für GTI und Golf R	Z	
VW	Golf VIII Hatchback (CD1)	07/2019-	421676500001	2	45	auch für 4motion nicht für Fahrzeuge mit Niveauregulierung nicht für GTI und Golf R	Z	HD
VW	Golf VIII Variant (CG5)	08/2020-	405403500001	1,5	45	auch für 4motion nicht für Fahrzeuge mit Niveauregulierung nicht für Golf R	Z	
VW	Golf VIII Variant (CG5)	08/2020-	421676500001	2	45	auch für 4motion nicht für Fahrzeuge mit Niveauregulierung nicht für Golf R	Z	HD
VW	Jetta III (1K2)	08/2005- 10/2010	421600500001	1,3	30	auch für 4motion und Bluemotion nicht für Fahrzeuge mit Niveauregulierung	Z	
VW	Jetta IV (162, 163, AV2, AV3)	04/2010- 12/2017	421600500001	1,3	30	auch für 4motion, Bluemotion und Hybrid nicht für Fahrzeuge mit Niveauregulierung	Z	
VW	Passat B6 CC (357)	02/2008- 01/2012	421600500001	1,3	30	auch für 4motion und Bluemotion nicht für Fahrzeuge mit Niveauregulierung	Z	

Marke	Modell	Baujahr	Artikelnummer	Gewicht (kg)	Einbauzeit (min)	Bemerkungen	Z = Zusatz- A = Austausch- Feder	Heav Duty für dauerhaft beladene Fzg.
VW	Passat B6 Limousine (3C2)	03/2005-11/2010	421600500001	1,3	30	auch für 4motion und Bluemotion nicht für Fahrzeuge mit Niveauregulierung	Z	
VW	Passat B6 Variant (3C5)	08/2005-11/2010	421600500001	1,3	30	auch für 4motion und Bluemotion nicht für Fahrzeuge mit Niveauregulierung	Z	
VW	Passat B7 Limousine (362)	08/2010-12/2014	421600500001	1,3	30	auch für 4motion und Bluemotion nicht für Fahrzeuge mit Niveauregulierung	Z	
VW	Passat B7 Variant (365)	08/2010-12/2015	421600500001	1,3	30	auch für 4motion und Bluemotion nicht für Fahrzeuge mit Niveauregulierung	Z	
VW	Passat Limousine B8 (3G2, CB2)	08/2014-	405403500001	1,5	45	auch für 4motion nicht für Fahrzeuge mit Niveauregulierung	Z	
VW	Passat Variant Alltrack B8 (3G5, CB5)	05/2015-	405403500001	1,5	45	auch für 4motion nicht für Fahrzeuge mit Niveauregulierung	Z	
VW	Passat Variant B8 (3G5, CB5)	08/2014-	405403500001	1,5	45	auch für 4motion nicht für Fahrzeuge mit Niveauregulierung	Z	
VW	Sharan (7N1, 7N2)	05/2010-	421600500001	1,3	30	auch für Bluemotion nicht für Fahrzeuge mit Niveauregulierung	Z	
VW	Tiguan I (5N_)	09/2007-07/2018	421600500001	1,3	30	auch für 4motion und Bluemotion nicht für Fahrzeuge mit Niveauregulierung	Z	
VW	Tiguan II Allspace (BW2, BJ2)	03/2017-	405403500001	1,5	45	auch für 4motion nicht für Fahrzeuge mit Niveauregulierung	Z	
VW	Tiguan II Allspace (BW2, BJ2)	03/2017-	421676500001	2	45	auch für 4motion nicht für Fahrzeuge mit Niveauregulierung	Z	HD
VW	Tiguan II (AD1, AX1)	01/2016-	405403500001	1,5	45	nicht für Tiguan R auch für 4motion nicht für Fahrzeuge mit Niveauregulierung	Z	
VW	Tiguan II (AD1, AX1)	01/2016-	421676500001	2	45	nicht für Tiguan R auch für 4motion nicht für Fahrzeuge mit Niveauregulierung	Z	HD
VW	Touran I (1T1, 1T2)	02/2003-05/2015	421600500001	1,3	30	auch für Bluemotion nicht für Fahrzeuge mit Niveauregulierung	Z	
VW	Touran II (5T1)	05/2015-	405403500001	1,5	45		Z	

Marke	Modell	Baujahr	Artikelnummer	Gewicht (kg)	Einbauzeit (min)	Bemerkungen	Z = Zusatz- A = Austausch- Feder	Heav Duty für dauerhaft beladene Fzg.
VW	Touran II (5T1)	05/2015-	421676500001	2	45		Z	HD
VW	Transporter T3 Kasten/Bus (24_, 25_)	05/1979- 07/1992	421391500001	1,6	30	nicht für Syncro	Z	
VW	Transporter T4 Kasten/Bus (70_, 7D_)	07/1990- 04/2003	421391500001	1,6	30	auch für Syncro und Caravelle bis 1.490 kg Achslast hinten bei ALB- Regler	Z	
VW	Transporter T5 Kasten (7H_, 7E_)	04/2003- 08/2015	421651500001	1,6	30	auch für 4motion nicht für Fahrzeuge mit Niveauregulierung	Z	
VW	Transporter T5 Kasten (7H_, 7E_)	04/2003- 08/2015	421675500001	10,2	30	auch für 4motion	A	
VW	Transporter T5 Multivan (7H_, 7E_)	04/2003- 08/2015	421651500001	1,6	30	auch für 4motion nicht für Fahrzeuge mit Niveauregulierung	Z	
VW	Transporter T5 Multivan (7H_, 7E_)	04/2003- 08/2015	421675500001	10,2	30	auch für 4motion	A	
VW	Transporter T5 Pritsche (7J_)	04/2003- 08/2015	421651500001	1,6	30	auch für 4motion nicht für Fahrzeuge mit Niveauregulierung	Z	
VW	Transporter T5 Pritsche (7J_)	04/2003- 08/2015	421675500001	10,2	30	auch für 4motion	A	
VW	Transporter T6 Kasten (SG_, SH_)	04/2015-	421651500001	1,6	30	auch für 4motion nicht für Fahrzeuge mit Niveauregulierung	Z	
VW	Transporter T6 Kasten (SG_, SH_)	04/2015-	421675500001	10,2	30	auch für 4motion	A	
VW	Transporter T6 Multivan (SG_, SH_)	04/2015-	421651500001	1,6	30	auch für 4motion nicht für Fahrzeuge mit Niveauregulierung	Z	

Marke	Modell	Baujahr	Artikelnummer	Gewicht (kg)	Einbauzeit (min)	Bemerkungen	Z = Zusatz- A = Austausch- Feder	Heav Duty für dauerhaft beladene Fzg.
VW	Transporter T6 Multivan (SG_, SH_)	04/2015-	421675500001	10,2	30	auch für 4motion	A	
VW	Transporter T6 Pritsche (SF_, SJ_)	04/2015-	421651500001	1,6	30	auch für 4motion nicht für Fahrzeuge mit Niveauregulierung	Z	
VW	Transporter T6 Pritsche (SF_, SJ_)	04/2015-	421675500001	10,2	30	auch für 4motion	A	
VW	T-Roc (A11, D11)	07/2017-	405403500001	1,5	60	nicht für T-Roc R für Fahrzeuge mit Multilink-Achse auch für 4motion	Z	
VW	T-Roc (A11, D11)	07/2017-	421676500001	2	45	für Fahrzeuge mit Multilink-Achse auch für 4motion nicht für Fahrzeuge mit Niveauregulierung nicht für T-Roc R	Z	HD



Zertifizierter Zulieferer der Automobilindustrie

Westfalia-Automotive GmbH

Am Sandberg 45
33378 Rheda-Wiedenbrück

Telefon: +49 5242 907 0
Telefax: +49 5242 907 195

westfalia-automotive.com

